

Official

YOUTH EQUESTRIAN



DEVELOPMENT ASSOCIATION

Pattern Book

2023-2024

UPDATED 12/6/2023



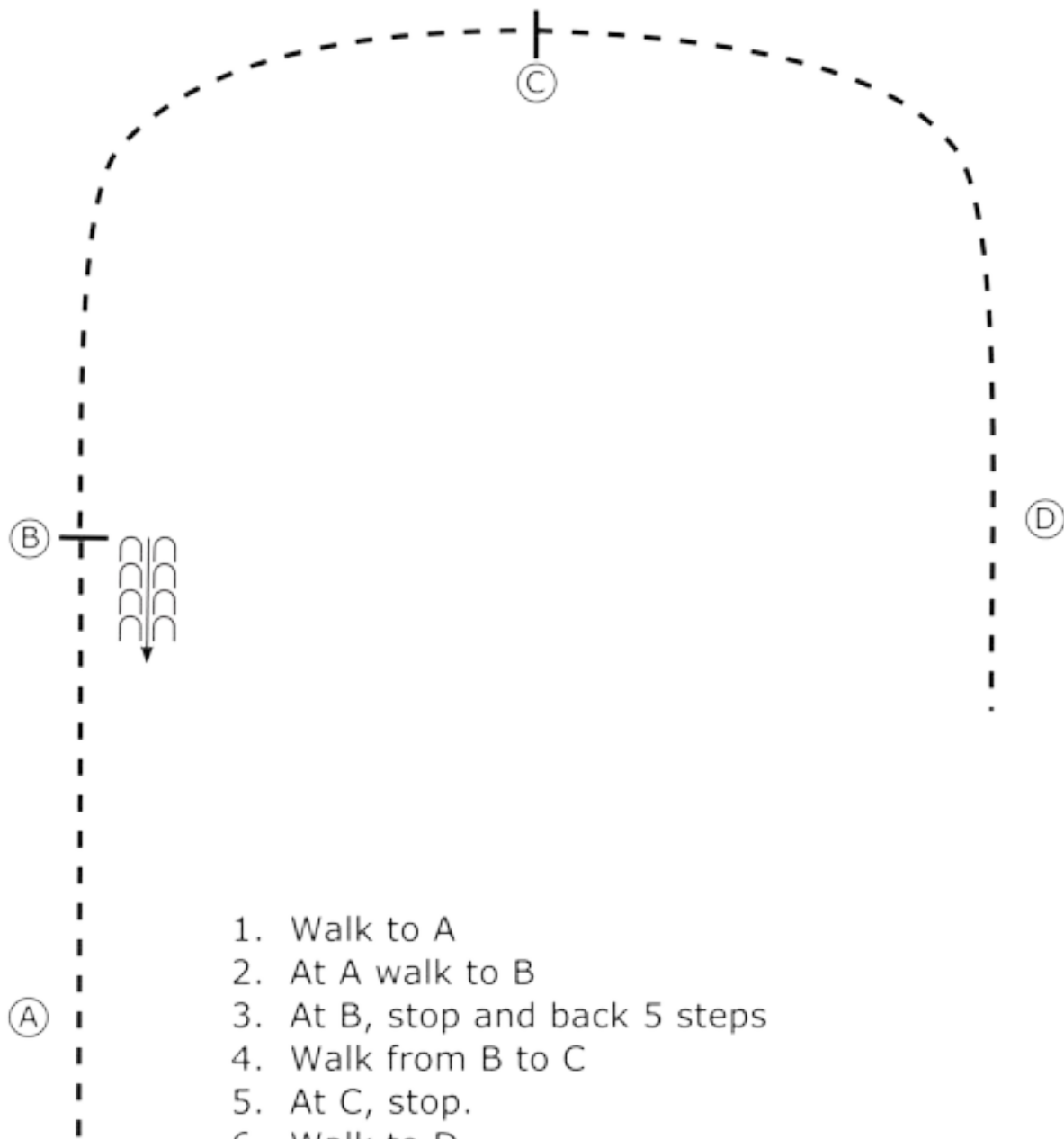

1. Walk to A
2. At A walk to B
3. At B, stop and back 5 steps
4. Walk from B to C
5. At C, stop.
6. Walk to D
7. Pattern is over when you pass D.

Walk ······
 Extended Walk - · - · - ·
 Jog - - -
 Extended Jog — — —
 Back ← 
 Marker (A)

Amber EWD Walk Pattern 3,4

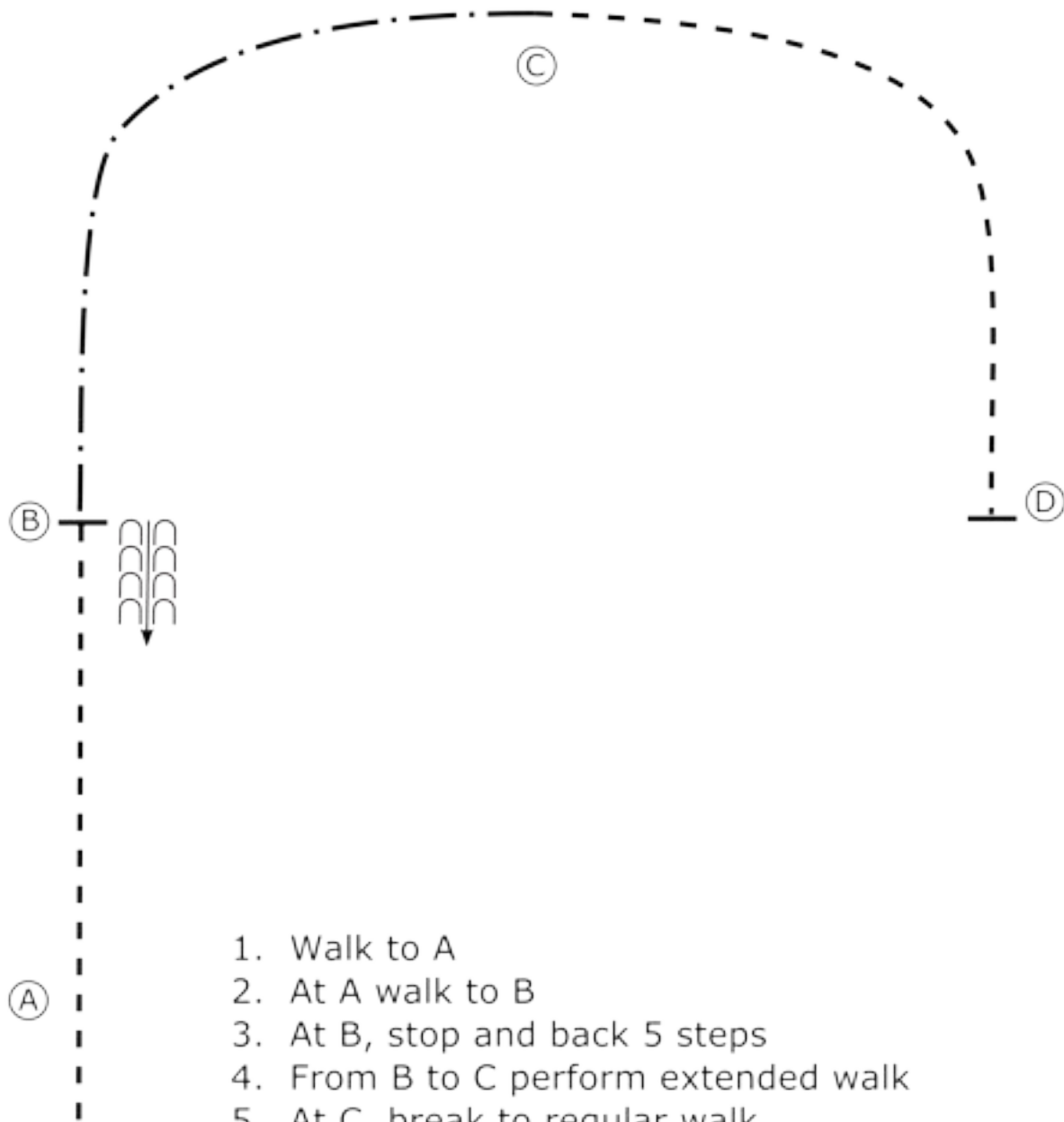

1. Walk to A
2. At A walk to B
3. At B, stop and back 5 steps
4. From B to C perform extended walk
5. At C, break to regular walk
6. At D, stop.

Walk ······
 Extended Walk -·-·-·-
 Jog - - -
 Extended Jog — — —
 Back ← 
 Marker (A)

Amber EWD Walk Pattern 5,6

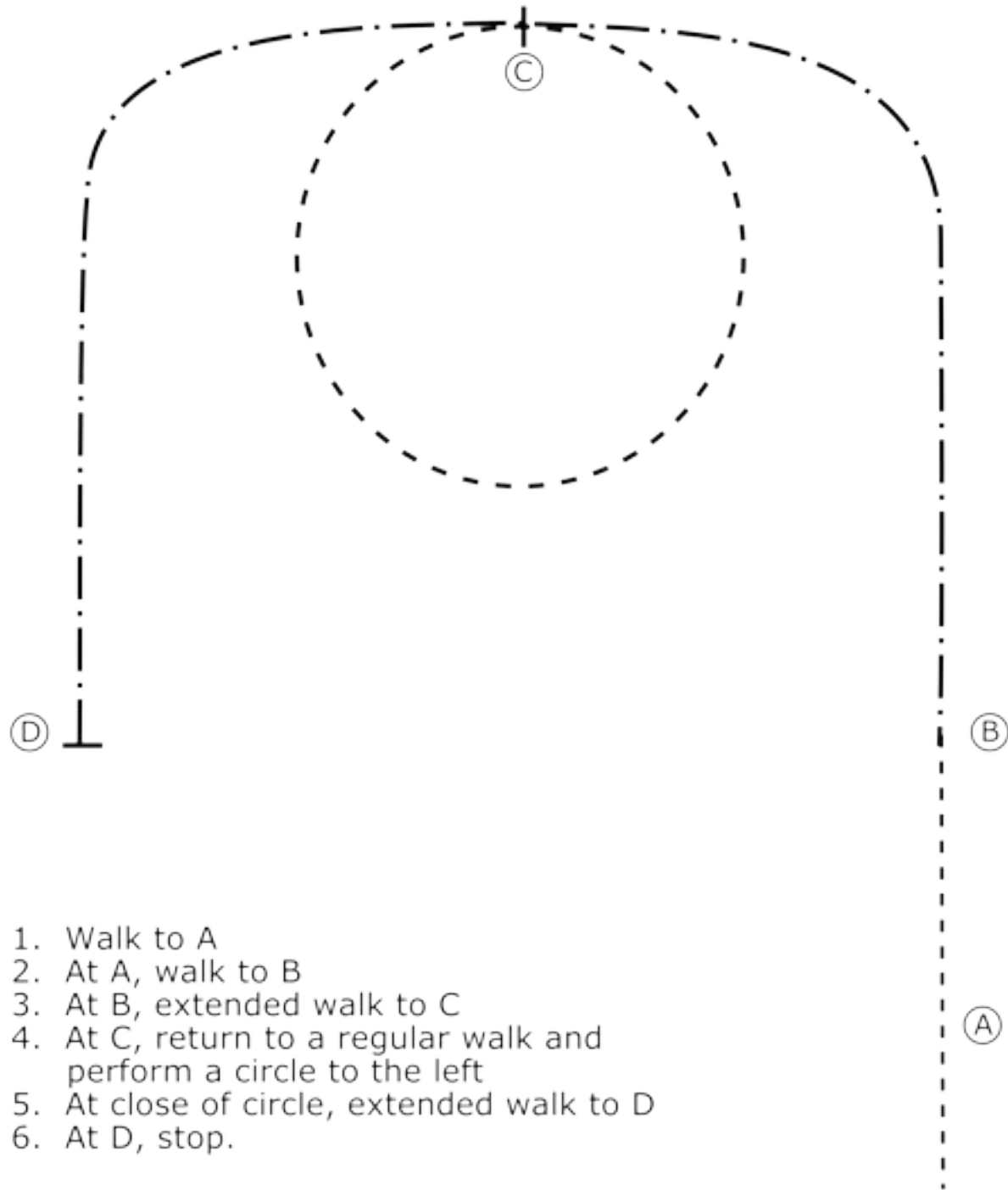

1. Walk to A
2. At A, walk to B
3. At B, extended walk to C
4. At C, return to a regular walk and perform a circle to the left
5. At close of circle, extended walk to D
6. At D, stop.

Walk ······

Extended Walk - · - · - ·

Jog - - -

Extended Jog — — —

Back ← 

Marker (A)

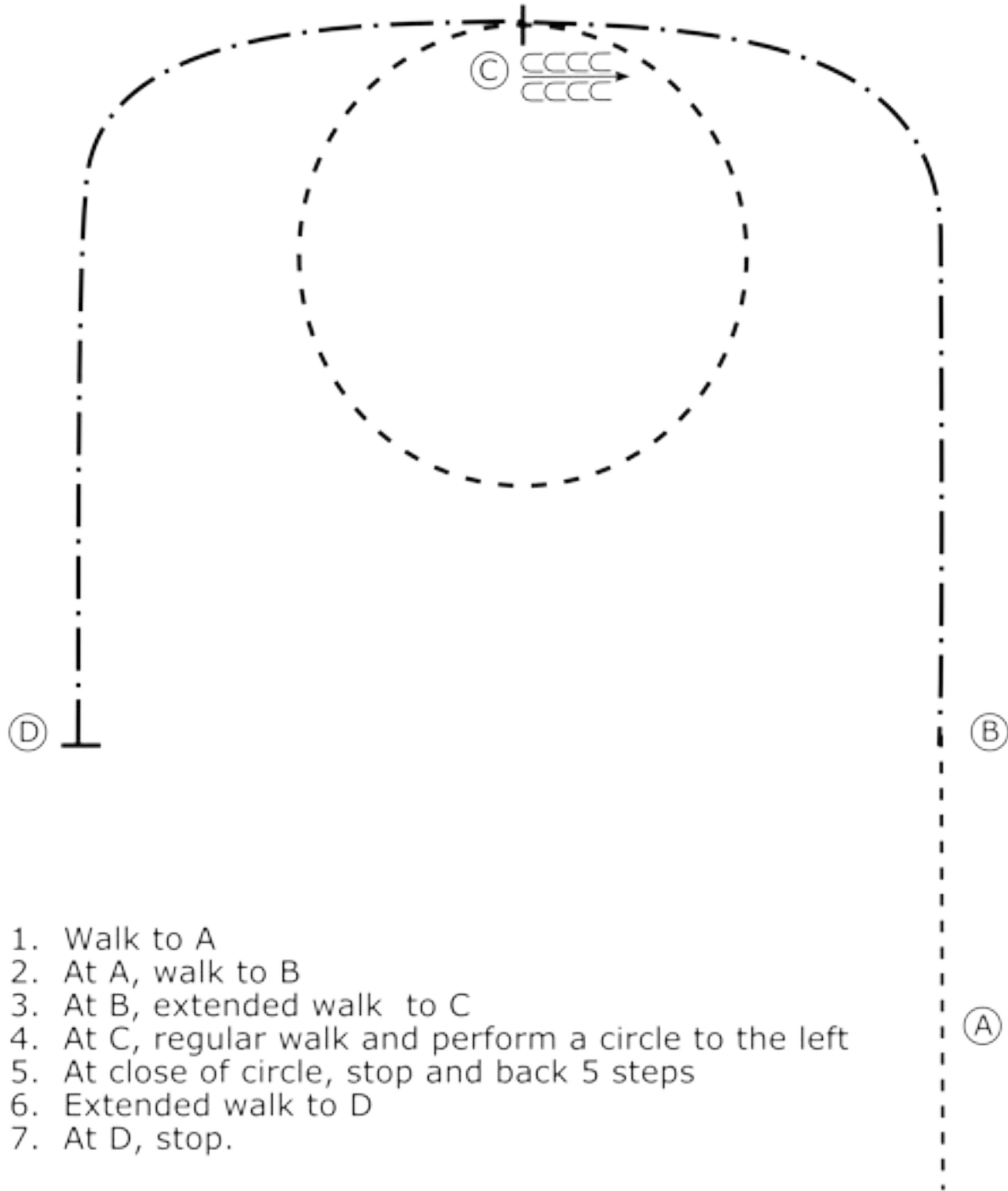

1. Walk to A
2. At A, walk to B
3. At B, extended walk to C
4. At C, regular walk and perform a circle to the left
5. At close of circle, stop and back 5 steps
6. Extended walk to D
7. At D, stop.

Walk ······

Extended Walk - · - · - ·

Jog - - -

Extended Jog — — —

Back ← 

Marker (A)

Amber EWD Walk Pattern 9,10

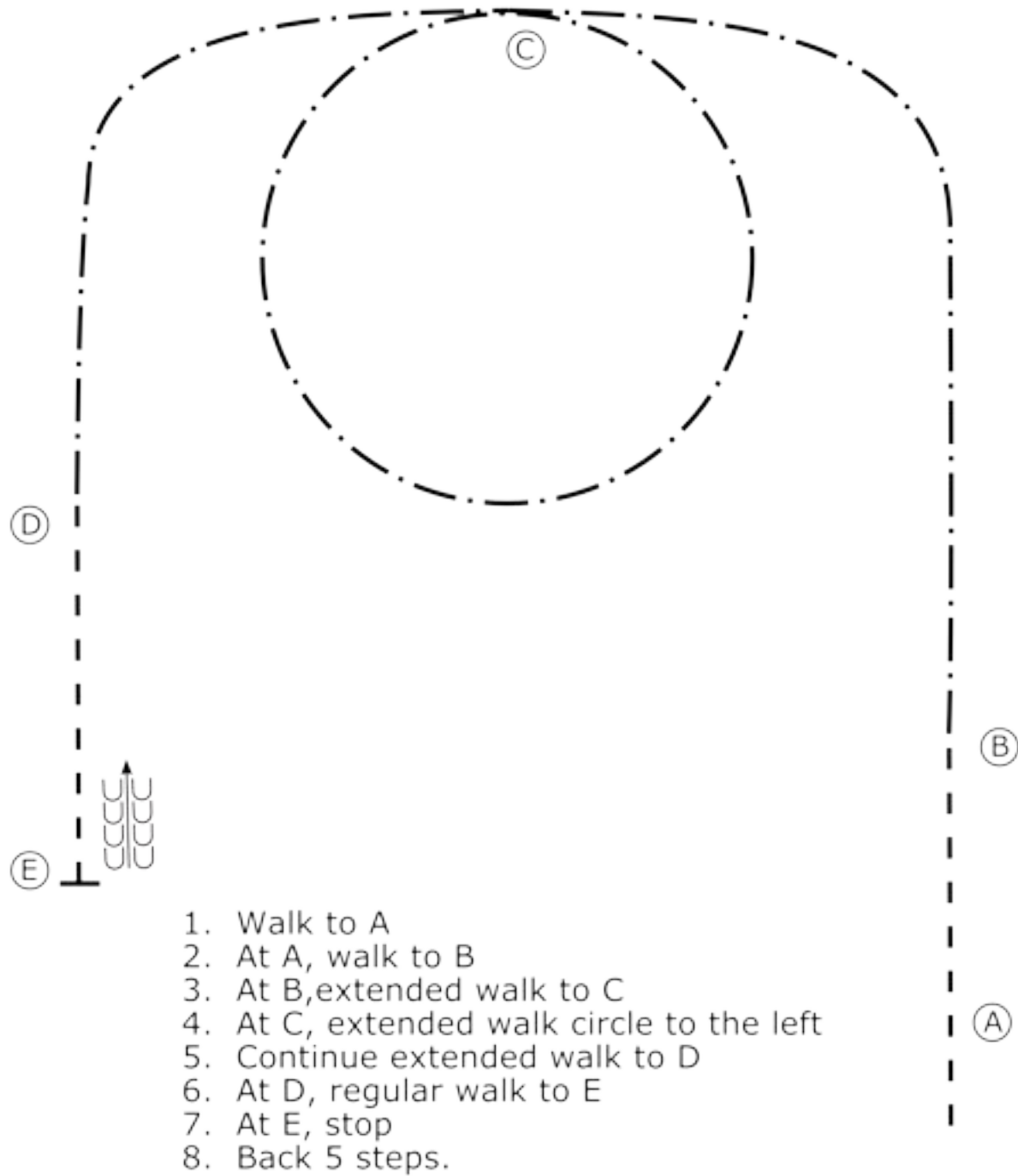

Walk
 Extended Walk - . - . -
 Jog - - -
 Extended Jog — — —
 Back ←
 Marker (A)

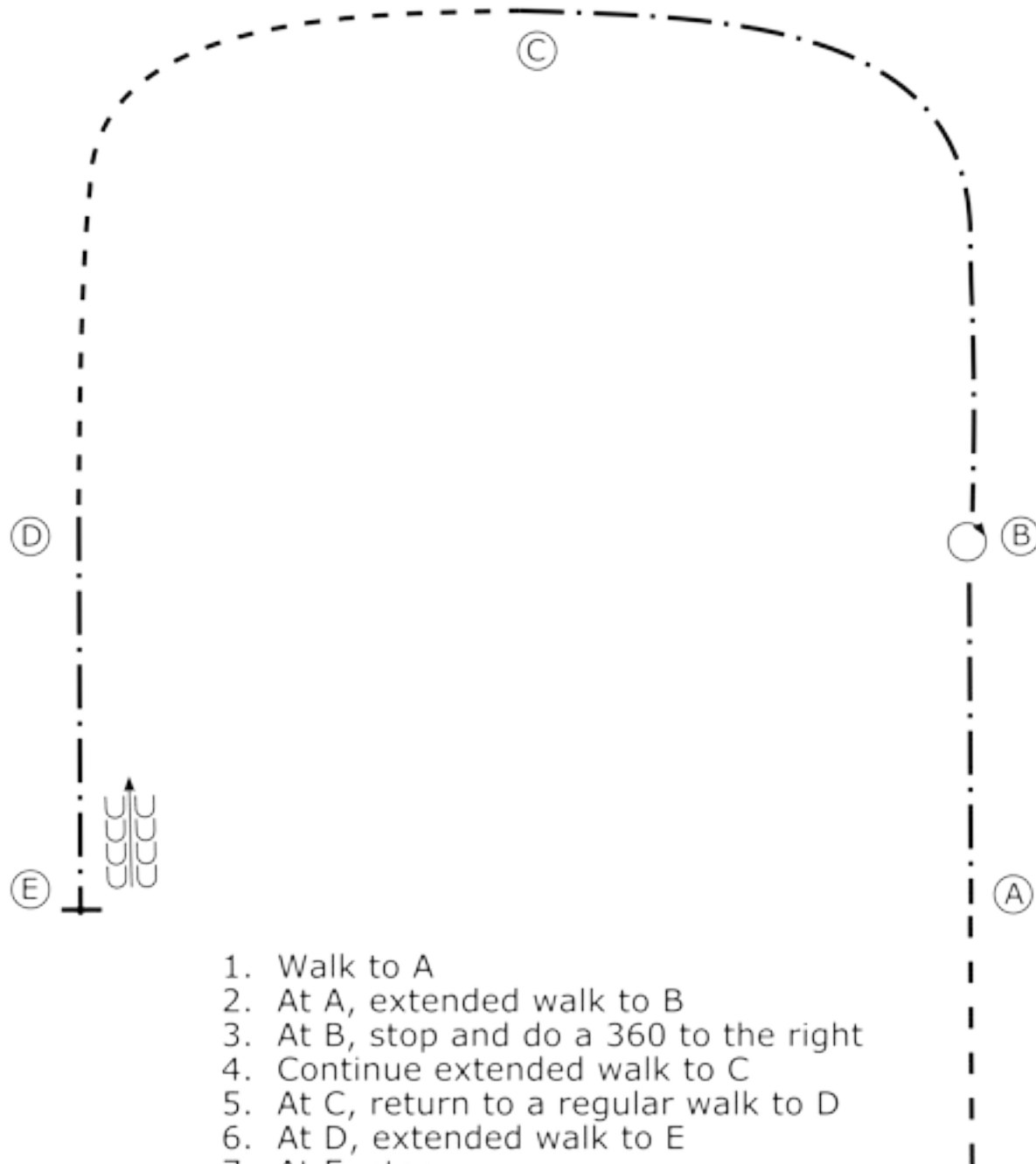

1. Walk to A
2. At A, extended walk to B
3. At B, stop and do a 360 to the right
4. Continue extended walk to C
5. At C, return to a regular walk to D
6. At D, extended walk to E
7. At E, stop
8. Back 5 steps.

Walk ······

Extended Walk - · - · - ·

Jog - - -

Extended Jog — — —

Back ← 

Marker (A)

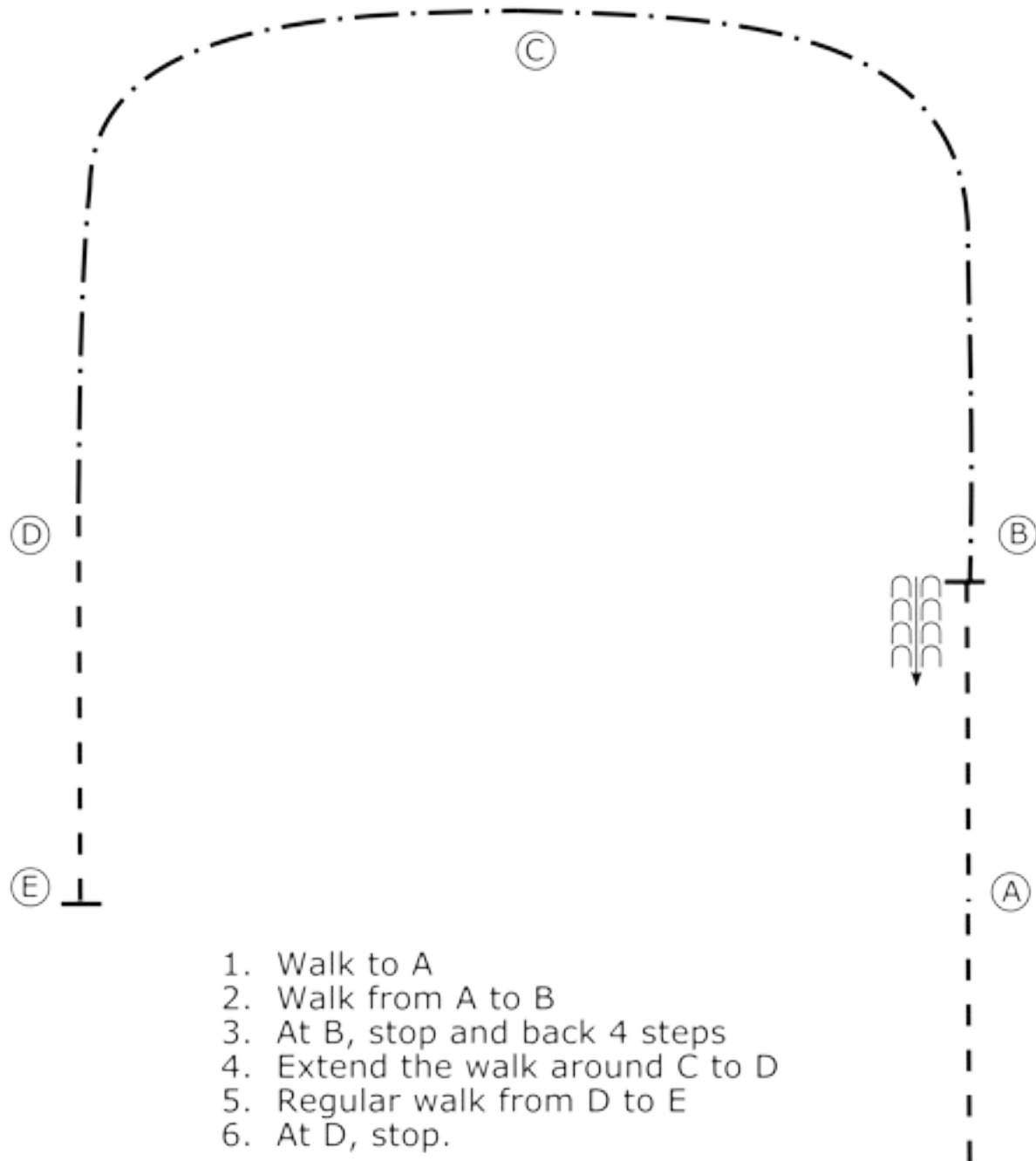

1. Walk to A
2. Walk from A to B
3. At B, stop and back 4 steps
4. Extend the walk around C to D
5. Regular walk from D to E
6. At D, stop.

Walk ······

Extended Walk - · - · - ·

Jog - - -

Extended Jog — — —

Back ← 

Marker (A)

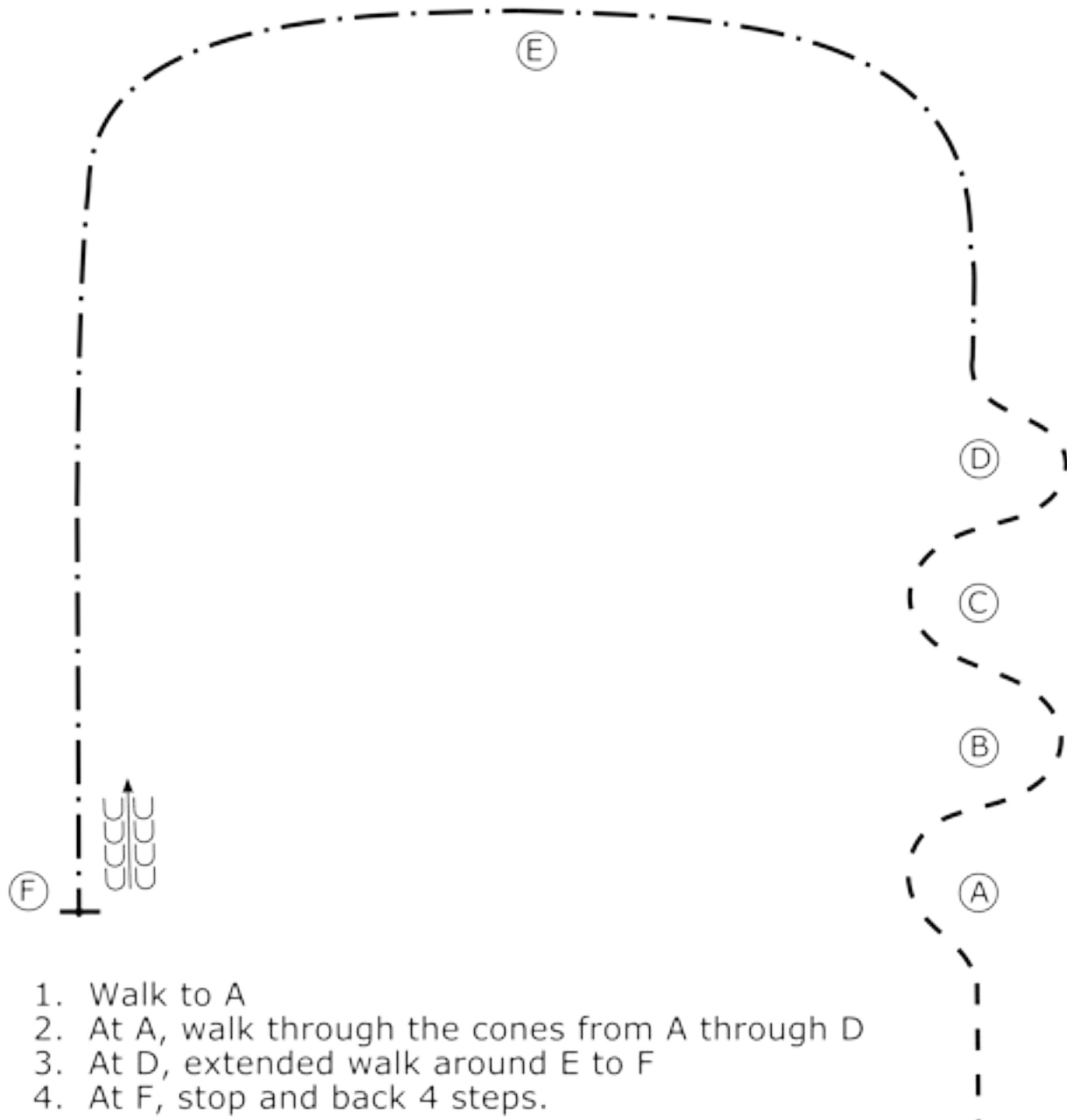

1. Walk to A
2. At A, walk through the cones from A through D
3. At D, extended walk around E to F
4. At F, stop and back 4 steps.

Walk ······
 Extended Walk - · - · -
 Jog - - -
 Extended Jog — — —
 Back ← 
 Marker (A)

Amber EWD Walk Pattern A, B

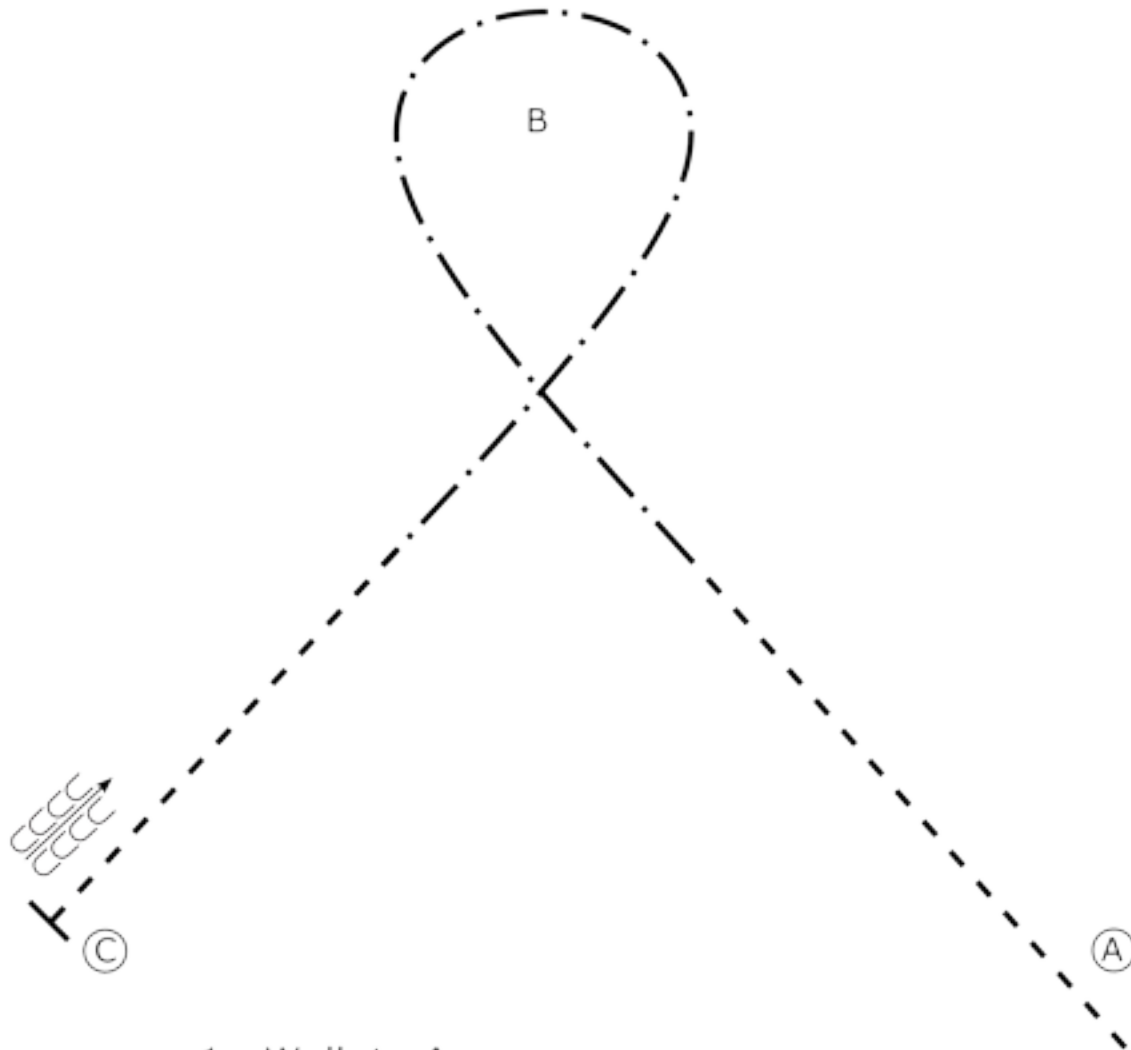

1. Walk to A
2. At A, walk halfway to B
3. Extend walk around B and halfway to C
4. Regular walk to C
5. At C, stop and back 4 steps.

Walk ······

Extended Walk - · - · - ·

Jog - - -

Extended Jog — — —

Back ←

Marker (A)

Topaz EWD W/T Pattern 1, 2

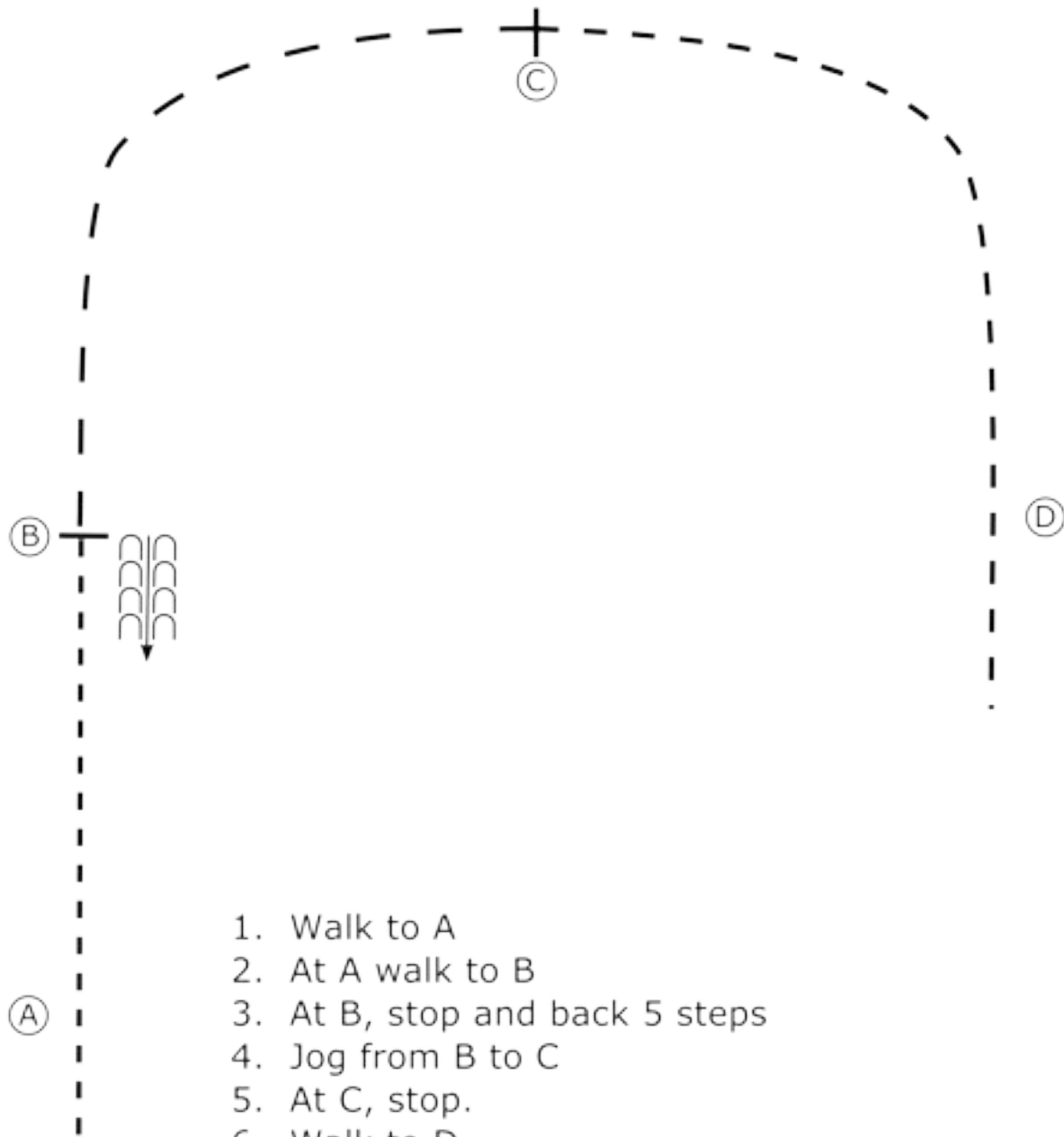

1. Walk to A
2. At A walk to B
3. At B, stop and back 5 steps
4. Jog from B to C
5. At C, stop.
6. Walk to D
7. Pattern is over when you pass D.

Walk ······
 Extended Walk - · - · -
 Jog - - -
 Extended Jog — — —
 Back ← 
 Marker (A)

Topaz EWD W/T Pattern 3,4

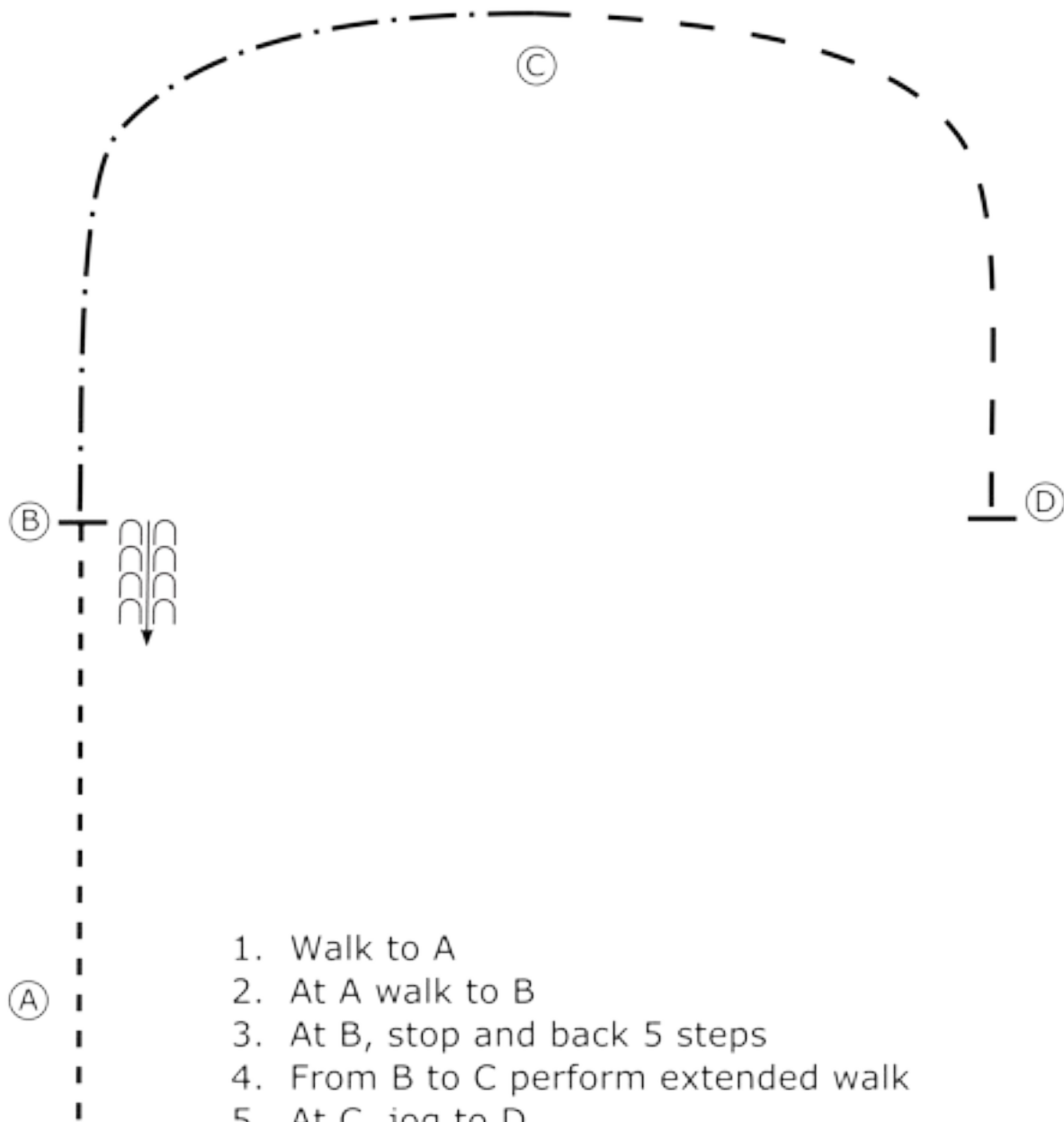

1. Walk to A
2. At A walk to B
3. At B, stop and back 5 steps
4. From B to C perform extended walk
5. At C, jog to D
6. At D, stop.

Walk ······
 Extended Walk - · - · -
 Jog - - -
 Extended Jog — — —
 Back ← 
 Marker (A)

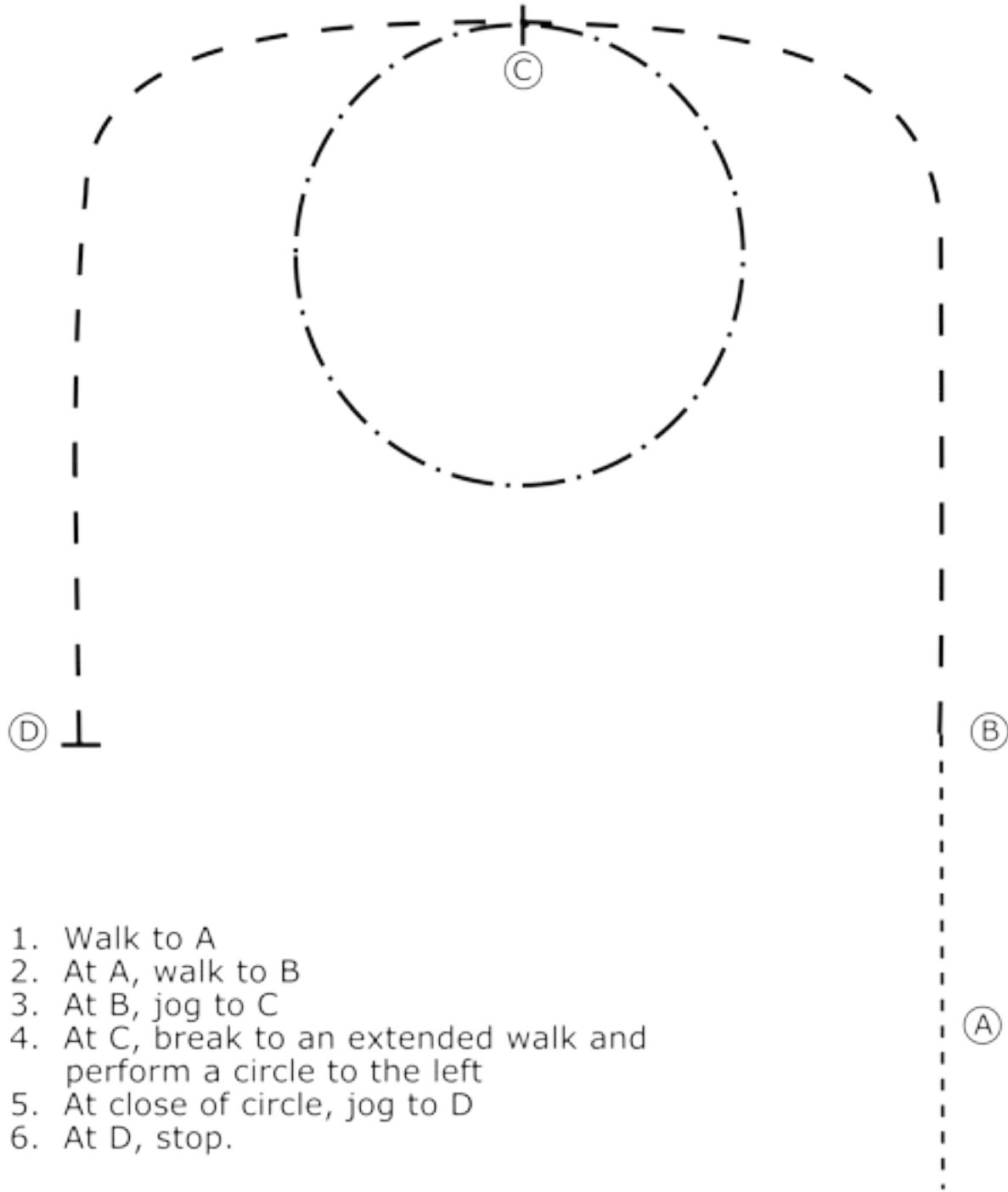

1. Walk to A
2. At A, walk to B
3. At B, jog to C
4. At C, break to an extended walk and perform a circle to the left
5. At close of circle, jog to D
6. At D, stop.

Walk ······

Extended Walk - · - · - ·

Jog - - -

Extended Jog — — —

Back ← 

Marker (A)

Topaz EWD W/T Pattern 7,8

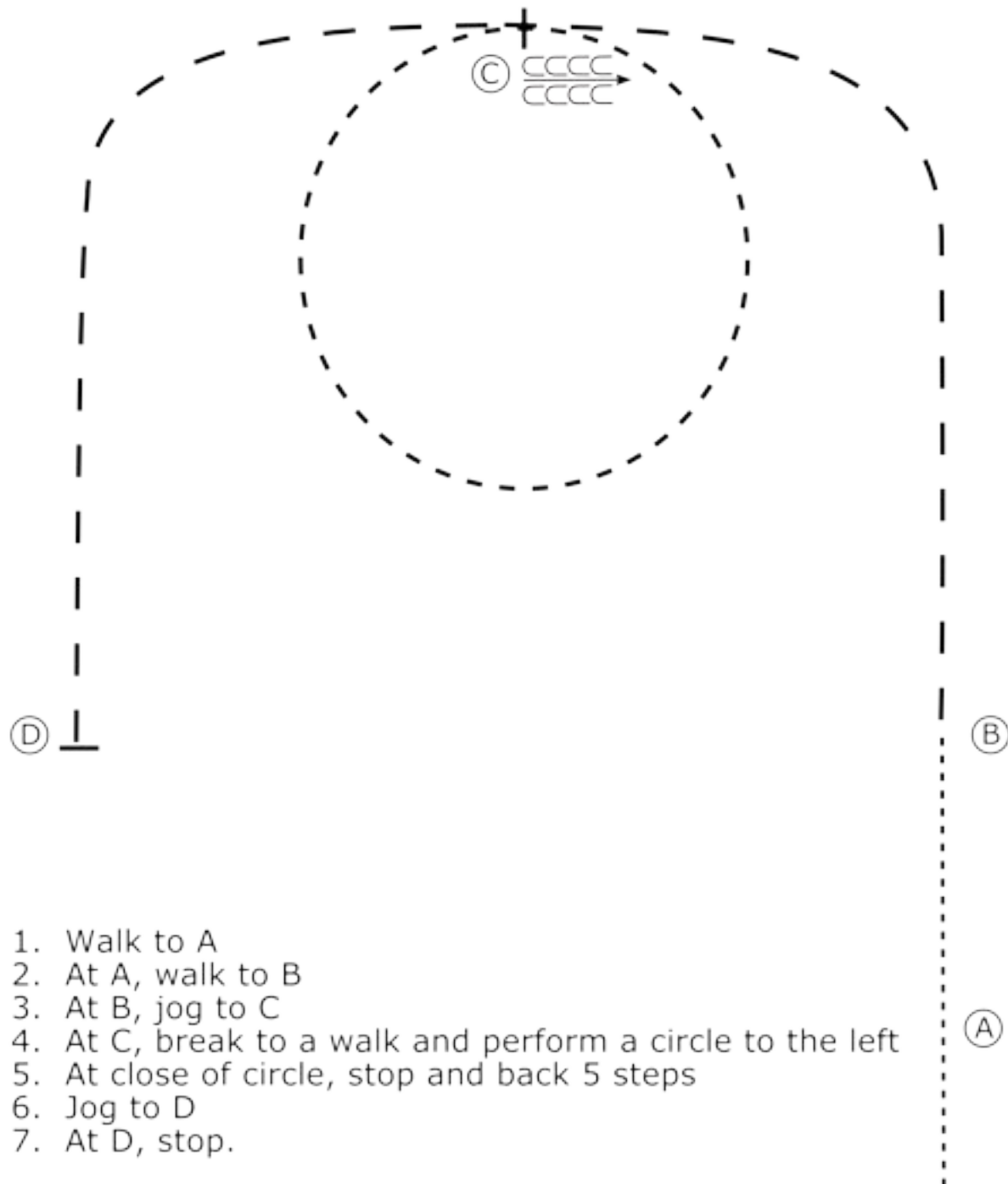

1. Walk to A
2. At A, walk to B
3. At B, jog to C
4. At C, break to a walk and perform a circle to the left
5. At close of circle, stop and back 5 steps
6. Jog to D
7. At D, stop.

Walk
 Extended Walk - . - . -
 Jog - - -
 Extended Jog — — —
 Back ← 
 Marker (A)

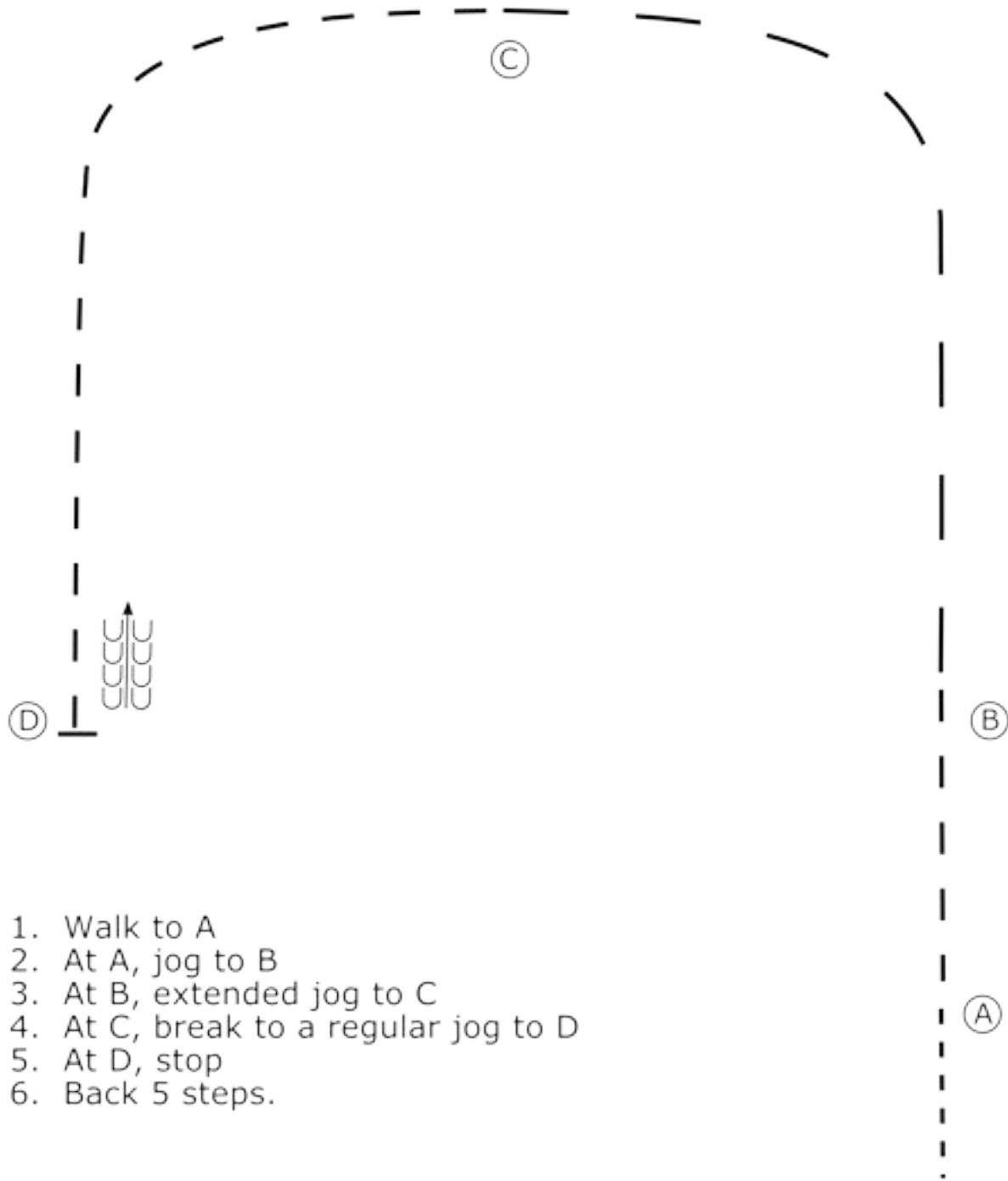

1. Walk to A
2. At A, jog to B
3. At B, extended jog to C
4. At C, break to a regular jog to D
5. At D, stop
6. Back 5 steps.

Walk ······

Extended Walk - · - · - ·

Jog - - -

Extended Jog — — —

Back ← 

Marker (A)

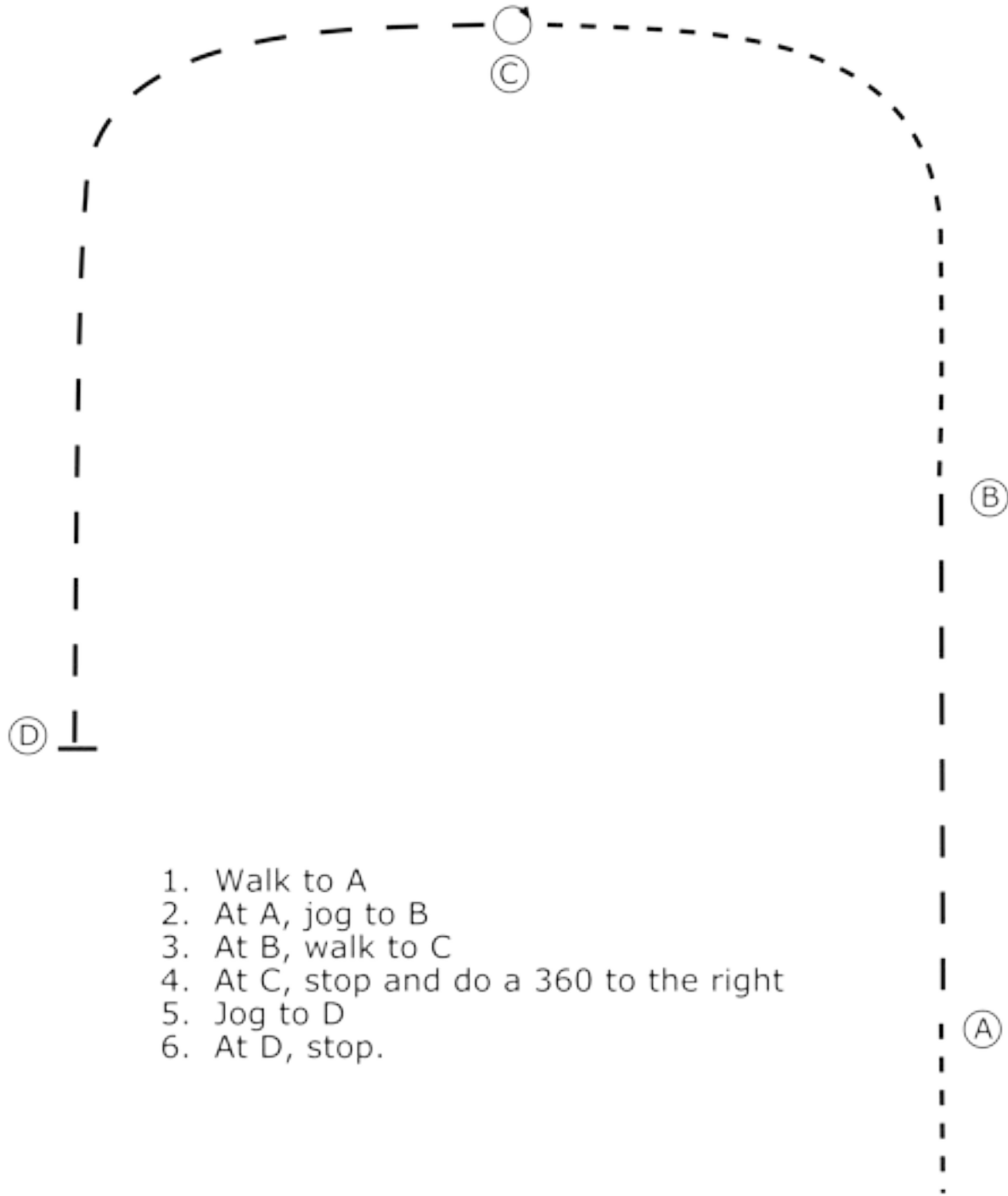

1. Walk to A
2. At A, jog to B
3. At B, walk to C
4. At C, stop and do a 360 to the right
5. Jog to D
6. At D, stop.

Walk ······
 Extended Walk - · - · -
 Jog - - -
 Extended Jog — — —
 Back ← 
 Marker (A)

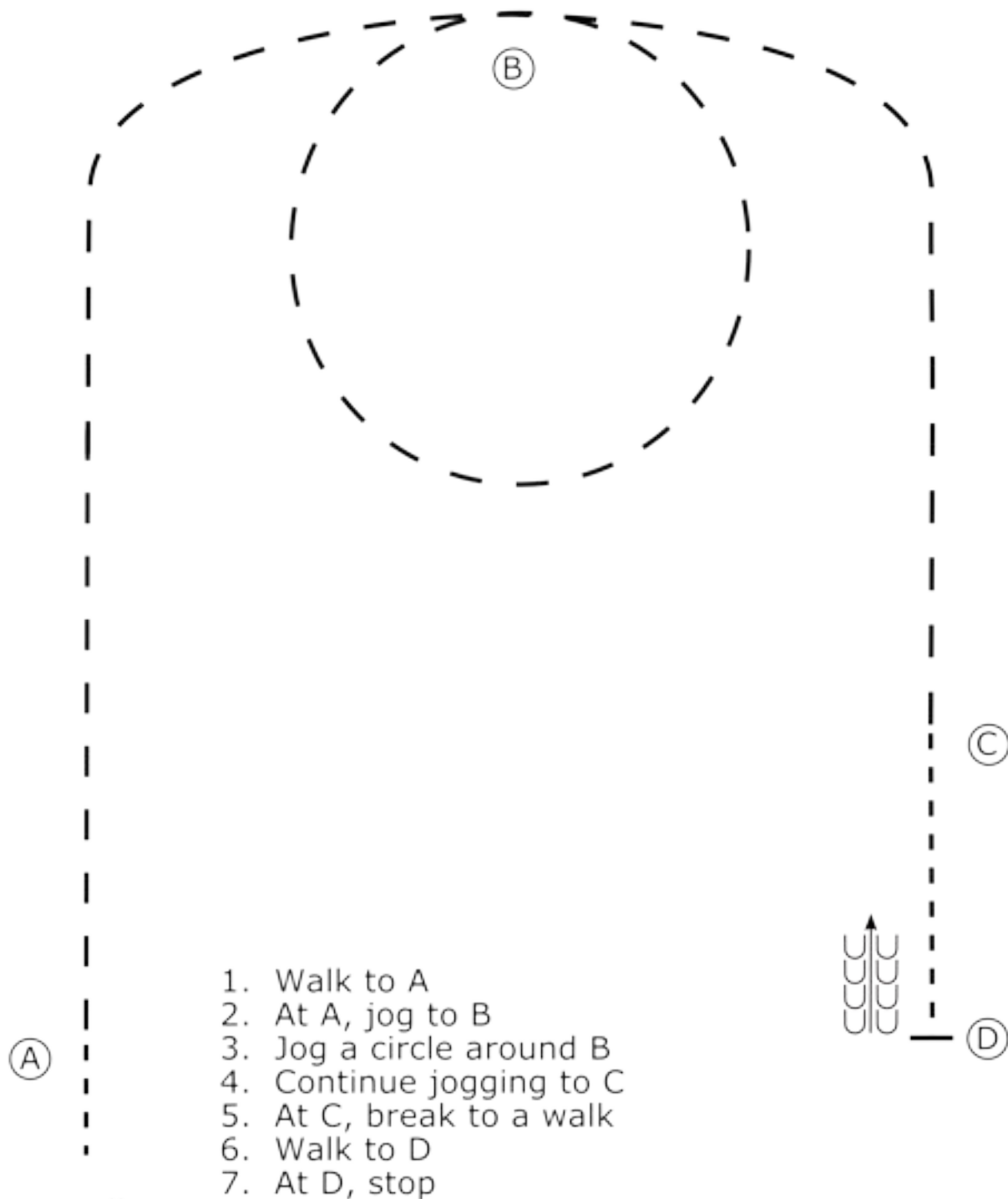

1. Walk to A
2. At A, jog to B
3. Jog a circle around B
4. Continue jogging to C
5. At C, break to a walk
6. Walk to D
7. At D, stop
8. Back.

Walk
 Extended Walk - . - . -
 Jog - - -
 Extended Jog — —
 Back ← 
 Marker (A)

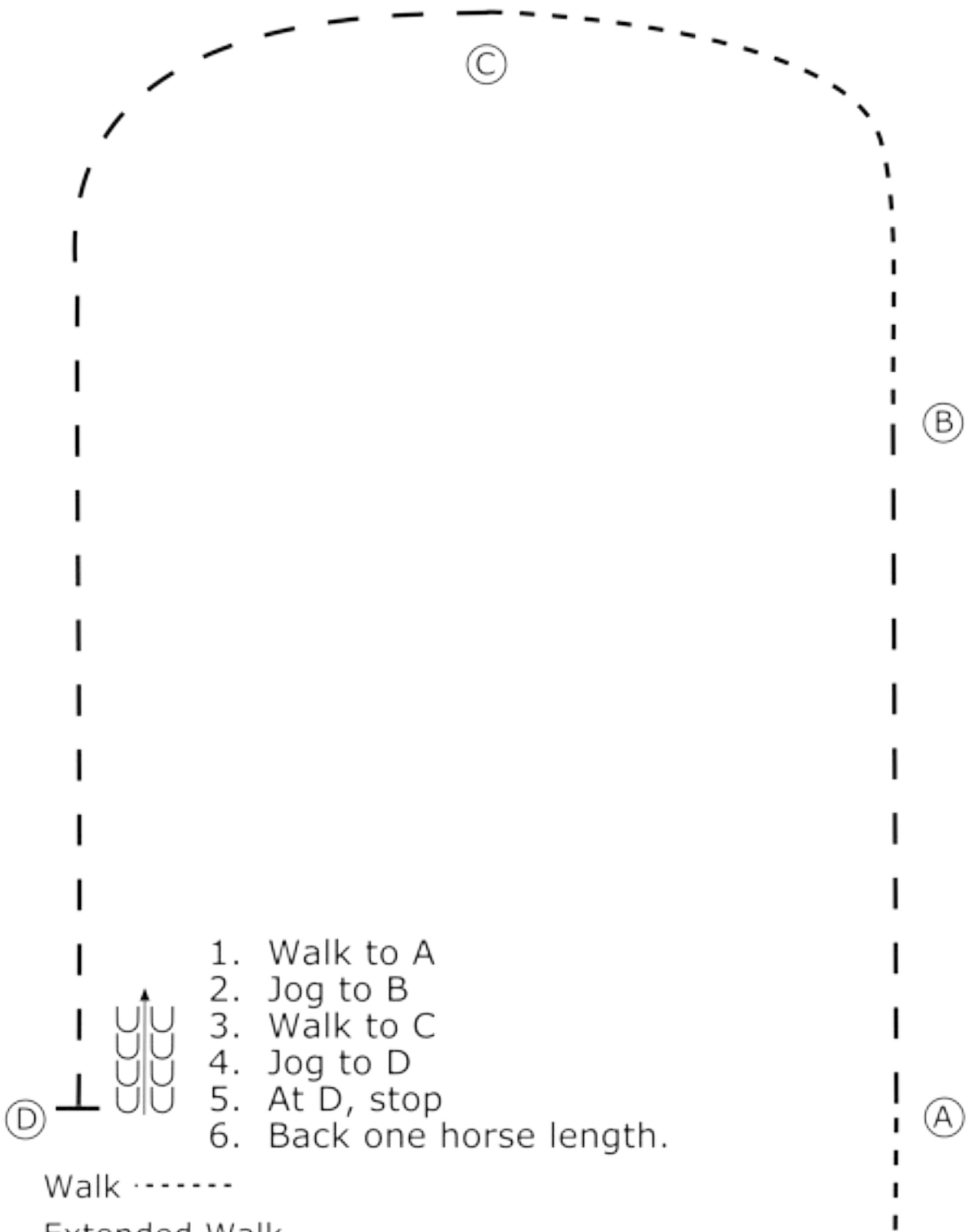

1. Walk to A
2. Jog to B
3. Walk to C
4. Jog to D
5. At D, stop
6. Back one horse length.

Walk ······

Extended Walk - · - · - ·

Jog - - -

Extended Jog — — —

Back ← 

Marker (A)

Topaz W/T EWD A, B

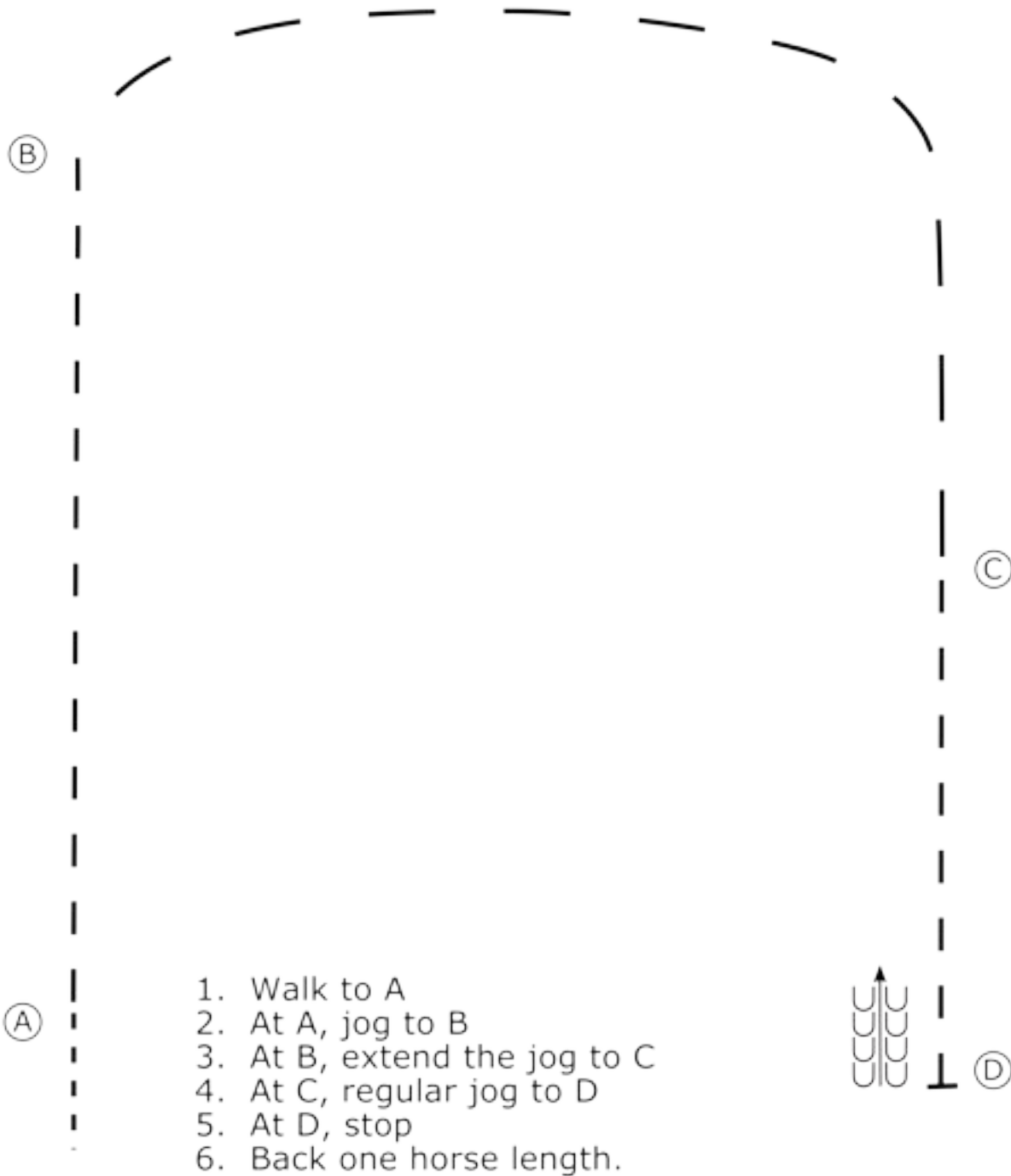

1. Walk to A
2. At A, jog to B
3. At B, extend the jog to C
4. At C, regular jog to D
5. At D, stop
6. Back one horse length.

Walk
 Extended Walk - . - . -
 Jog - - -
 Extended Jog — — —
 Back ← 
 Marker (A)

Pearl/Opal/Alumni Pattern 1

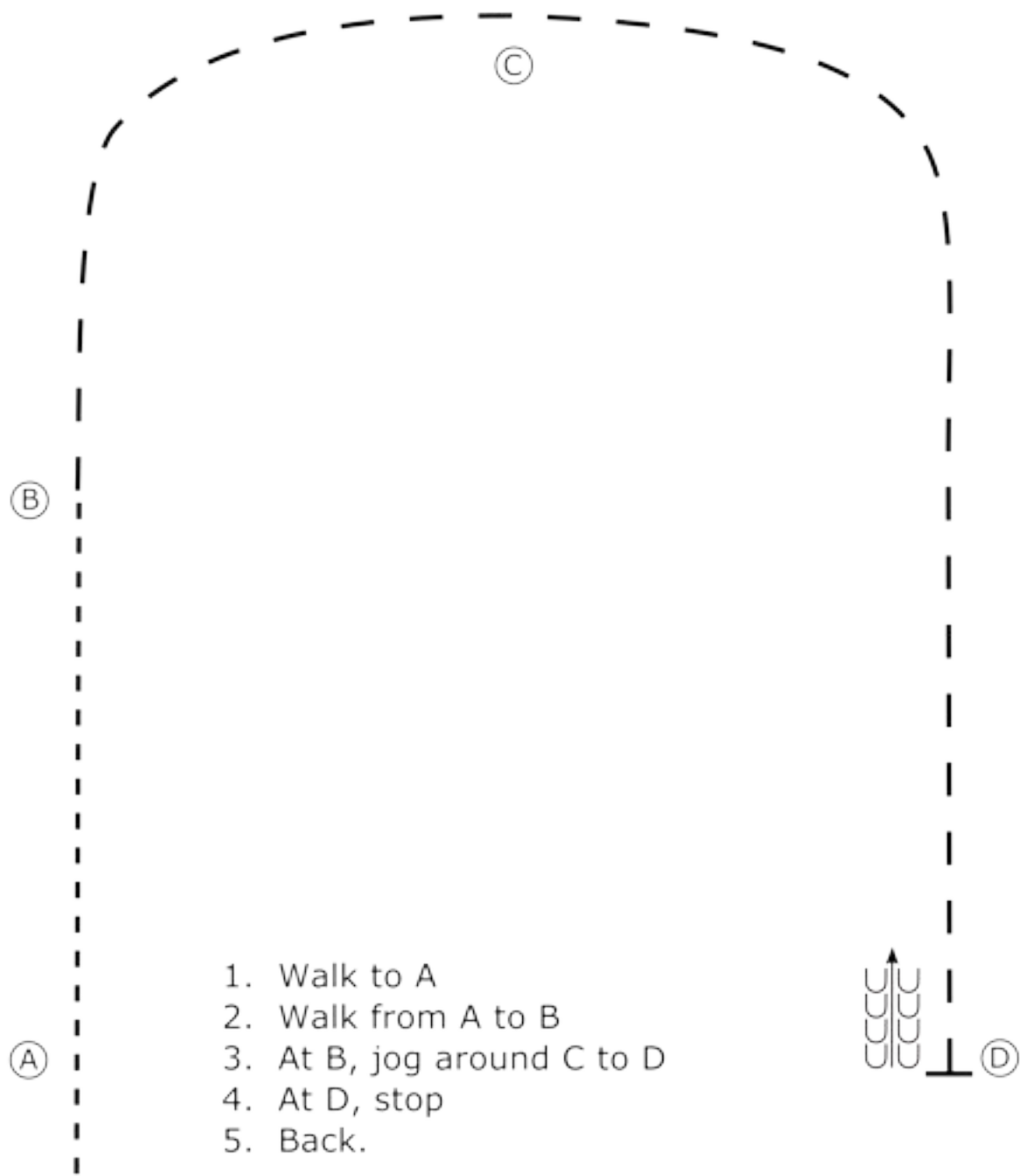

Walk
Jog - - -
Extended Jog — —
Back ← 
Marker (A)

Pearl/Opal/Alumni Pattern 2

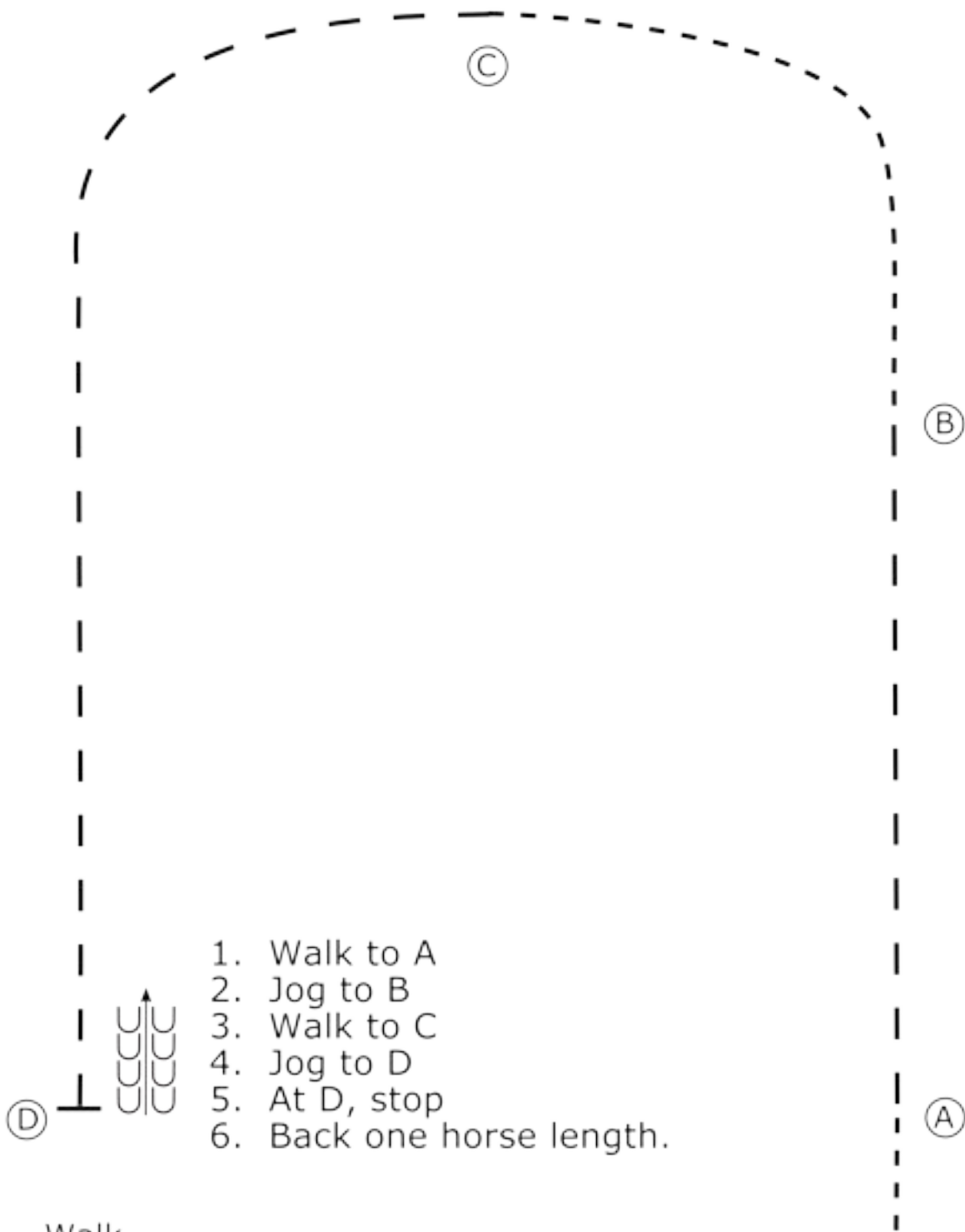

1. Walk to A
2. Jog to B
3. Walk to C
4. Jog to D
5. At D, stop
6. Back one horse length.

Walk
Jog - - -
Extended Jog — —
Back ← 
Marker (A)

Pearl/Opal/Alumni Pattern 3

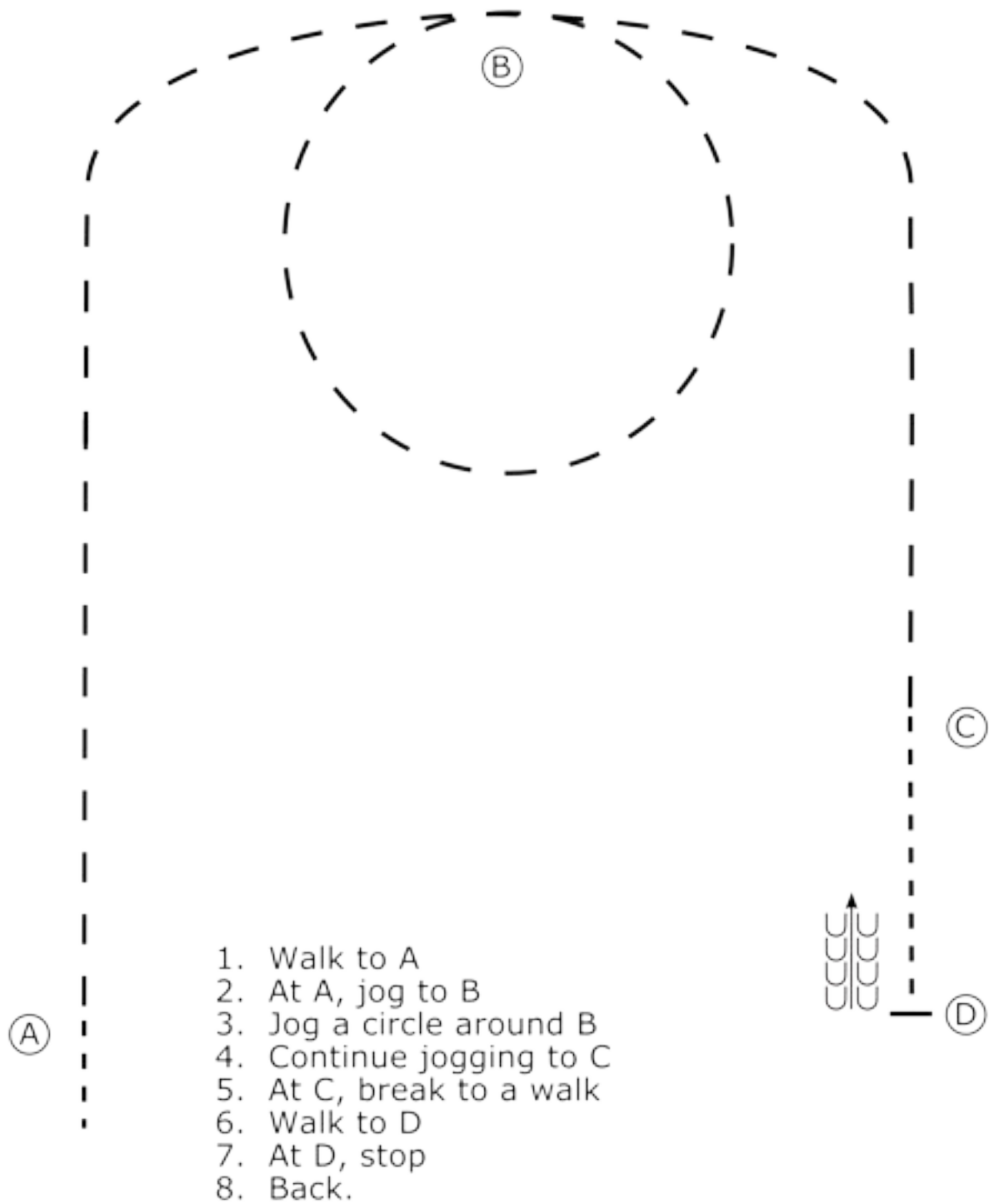

- Walk (dotted line)
- Jog - - - (dashed line)
- Extended Jog — — (solid line)
- Back ← 
- Marker (A)

Pearl/Opal/Alumni Pattern 4

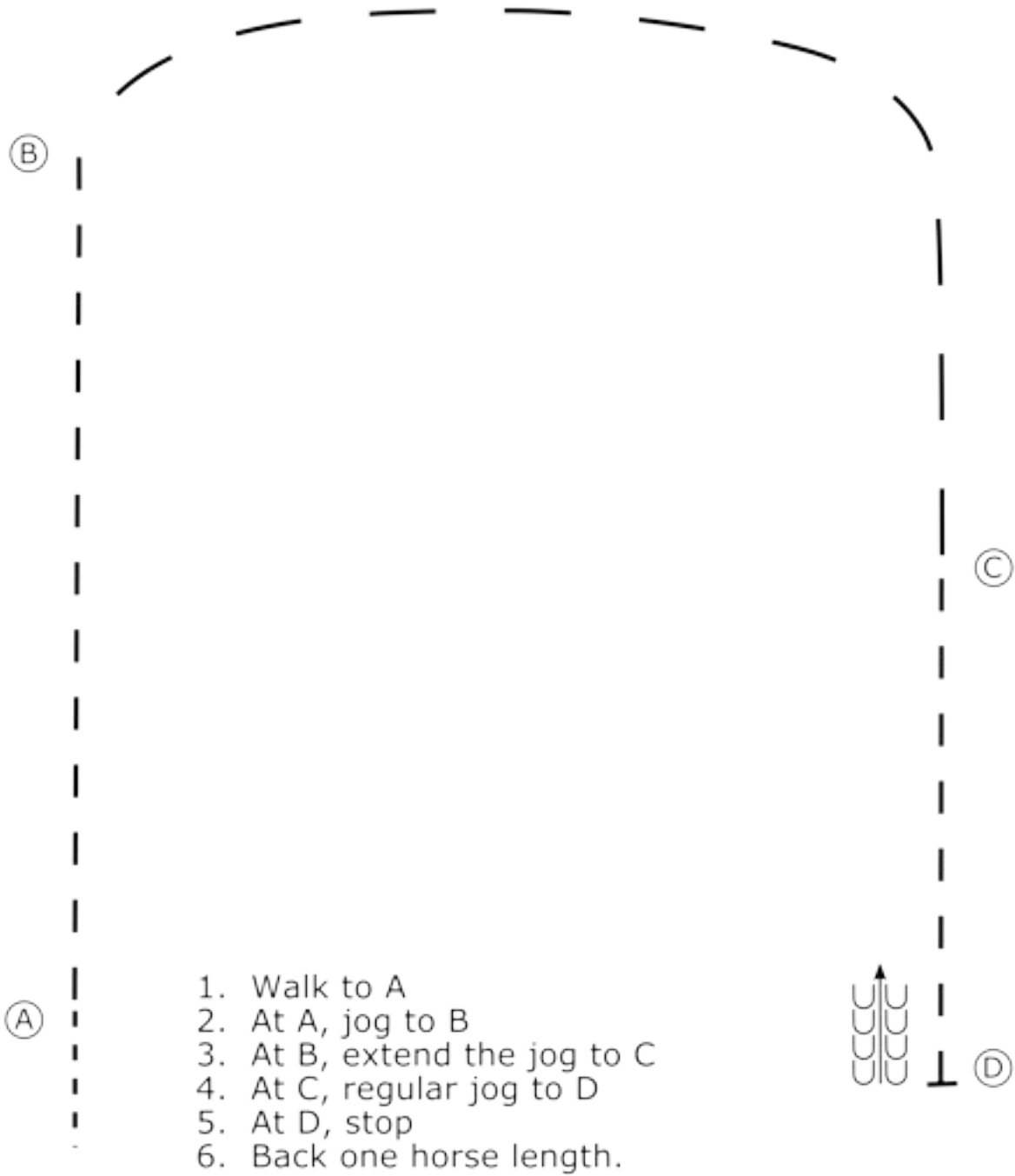

Walk
 Jog - - -
 Extended Jog — —
 Back ← 
 Marker Ⓐ

Pearl/Opal/Alumni Pattern 5

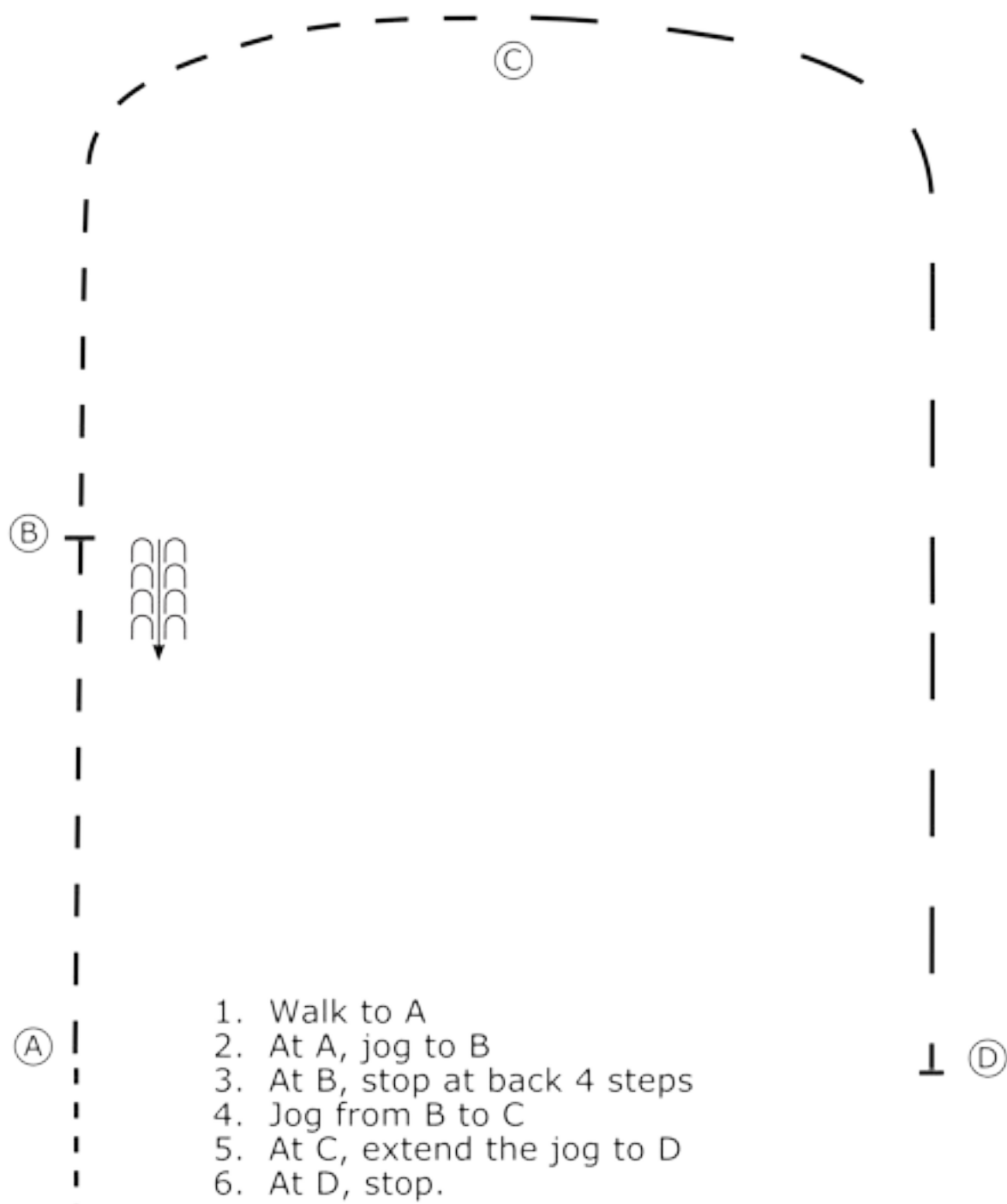

1. Walk to A
2. At A, jog to B
3. At B, stop at back 4 steps
4. Jog from B to C
5. At C, extend the jog to D
6. At D, stop.

Walk
 Jog - - -
 Extended Jog — —
 Back ← 
 Marker (A)

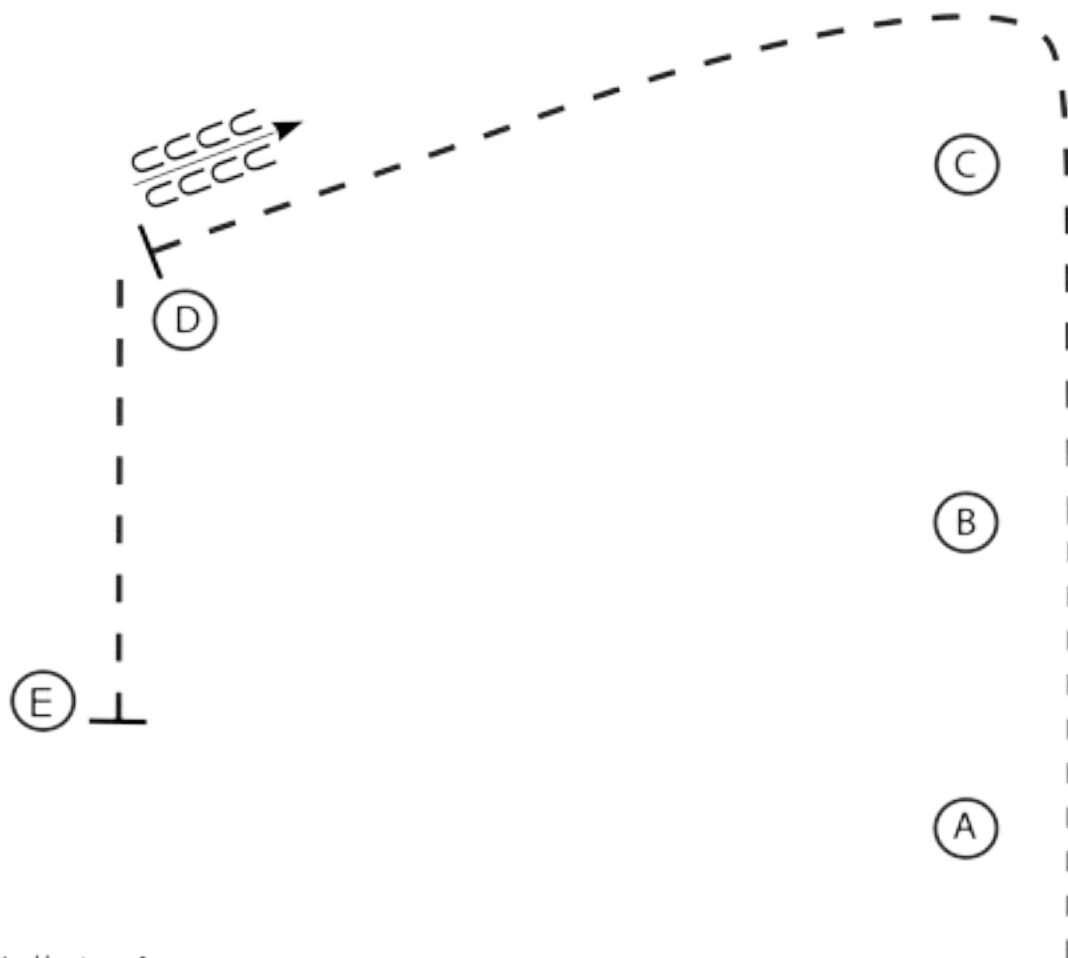

1. Walk to A
2. At A walk to B
3. At B, jog around C to D
4. At D, stop and back
5. Jog to E
6. Stop at E

Walk ······

Jog - - -

Extended Jog — —

Back ←

Marker (A)

Pearl/Opal/Alumni Pattern 7

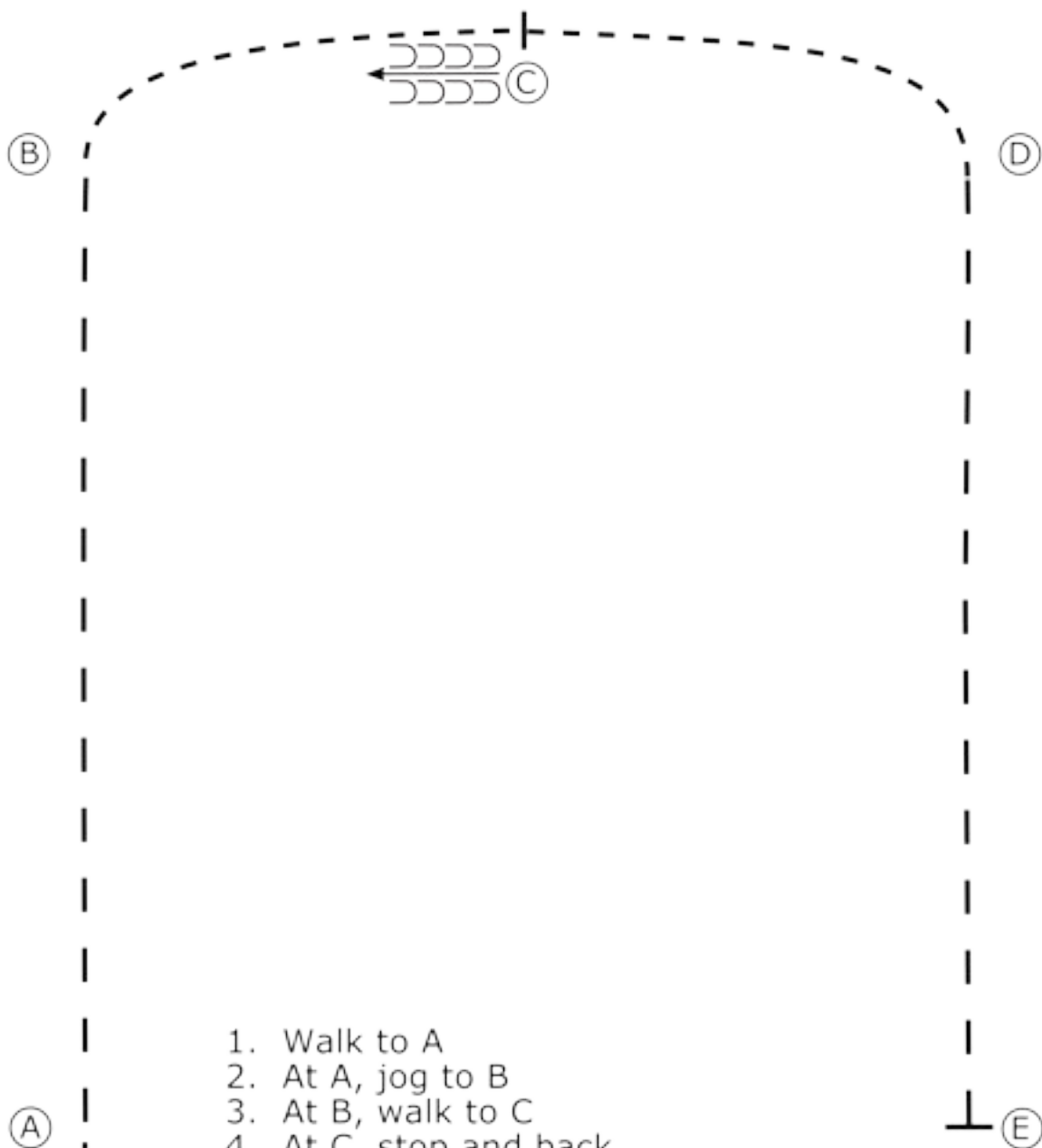

1. Walk to A
2. At A, jog to B
3. At B, walk to C
4. At C, stop and back
5. Continue to walk to D
6. At D, jog to E
7. At E, stop.

Walk
 Jog - - -
 Extended Jog — —
 Back ← 
 Marker (A)

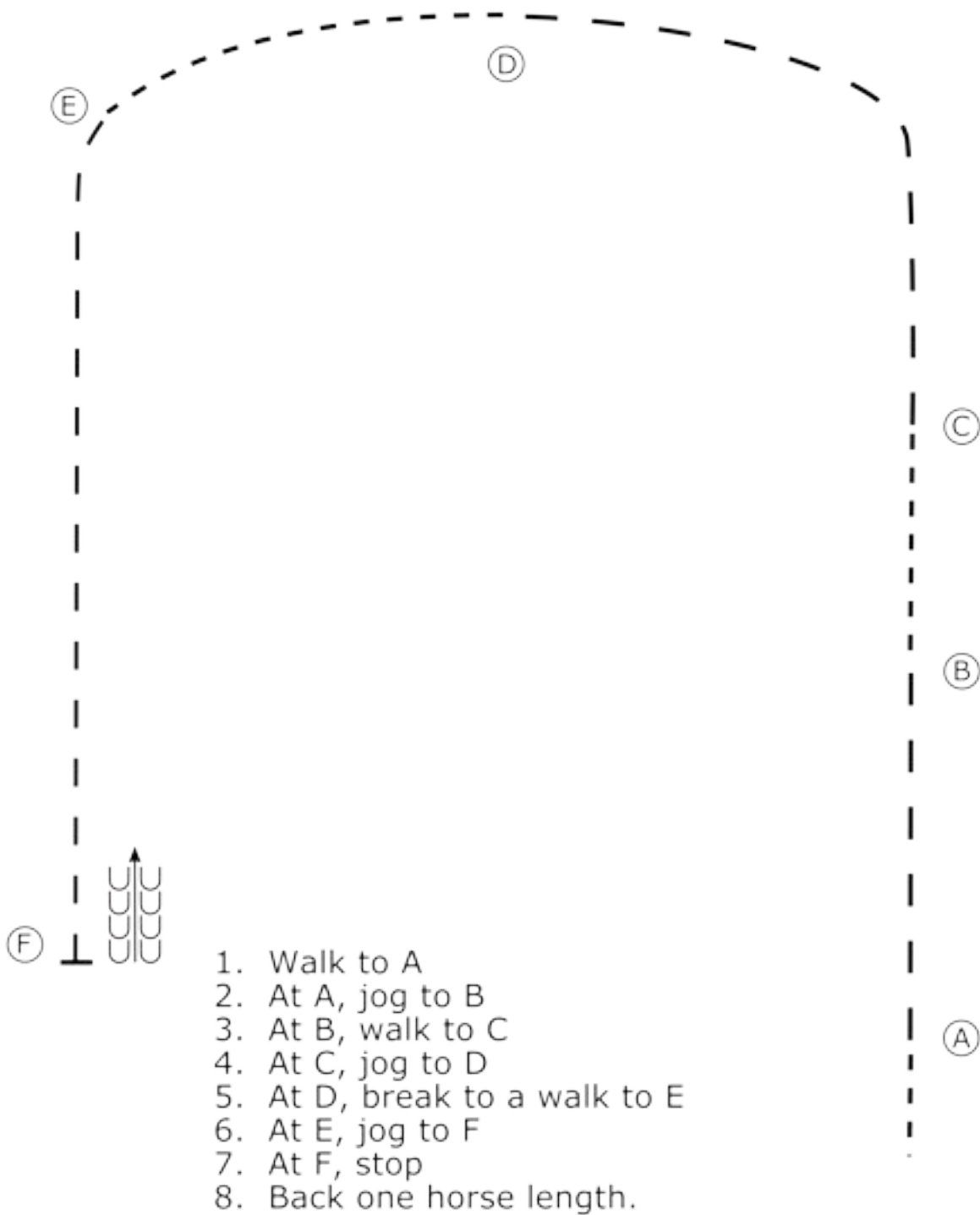

Walk ······

Jog - - -

Extended Jog — —

Back ← 

Marker (A)

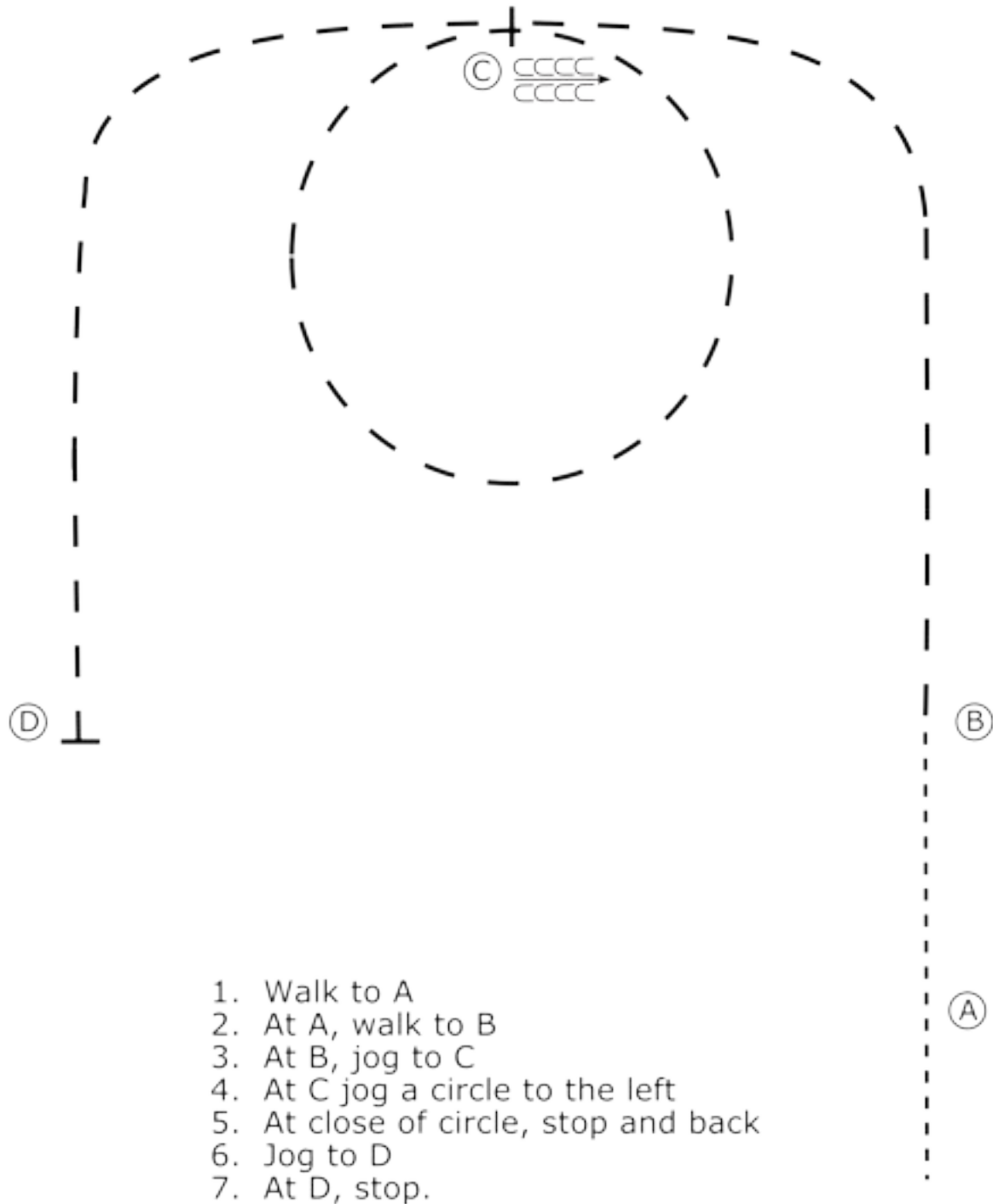

1. Walk to A
2. At A, walk to B
3. At B, jog to C
4. At C jog a circle to the left
5. At close of circle, stop and back
6. Jog to D
7. At D, stop.

Walk
 Jog - - -
 Extended Jog — — —
 Back ← 
 Marker Ⓐ

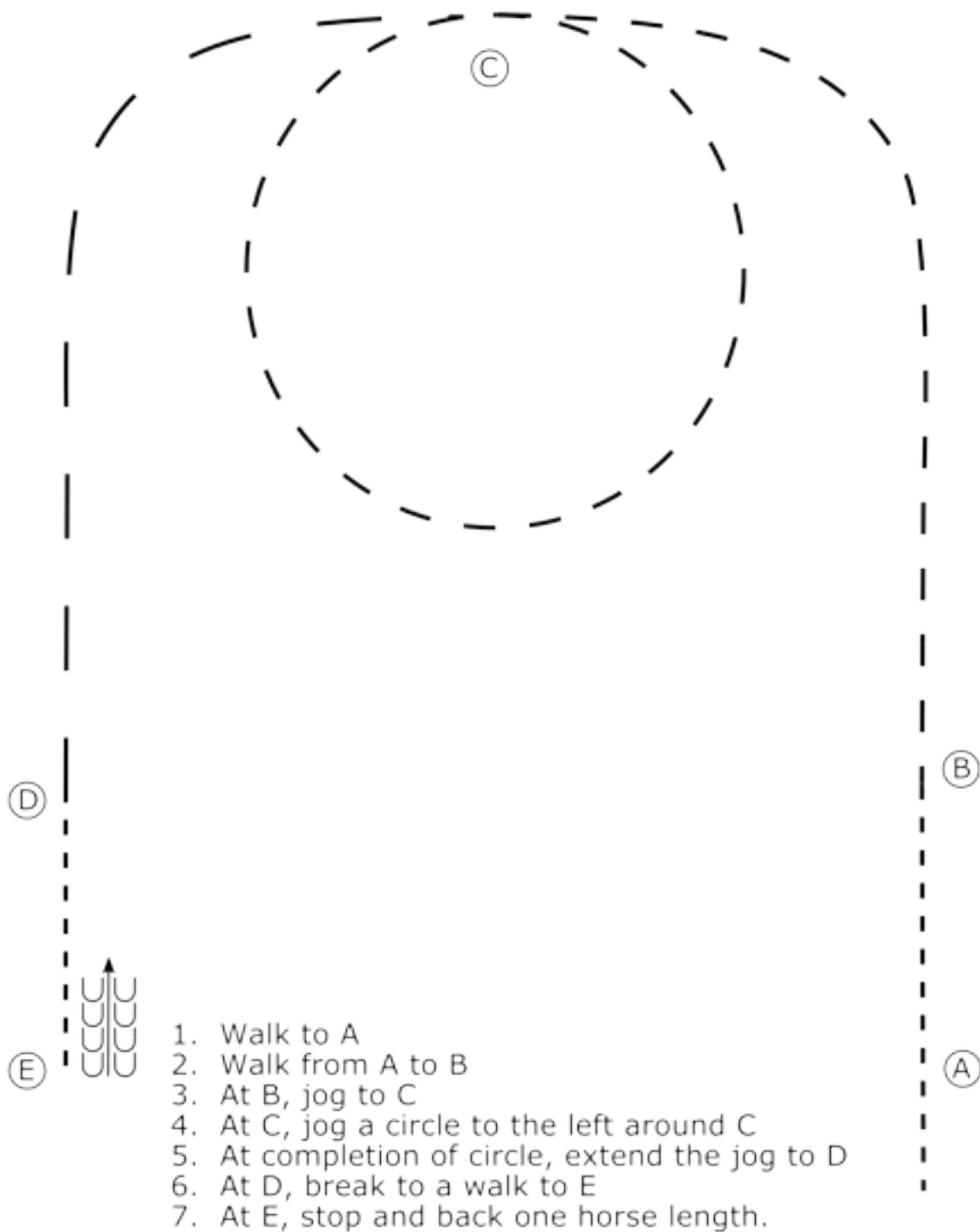

Walk ······

Jog - - -

Extended Jog — —

Back ← 

Marker (A)

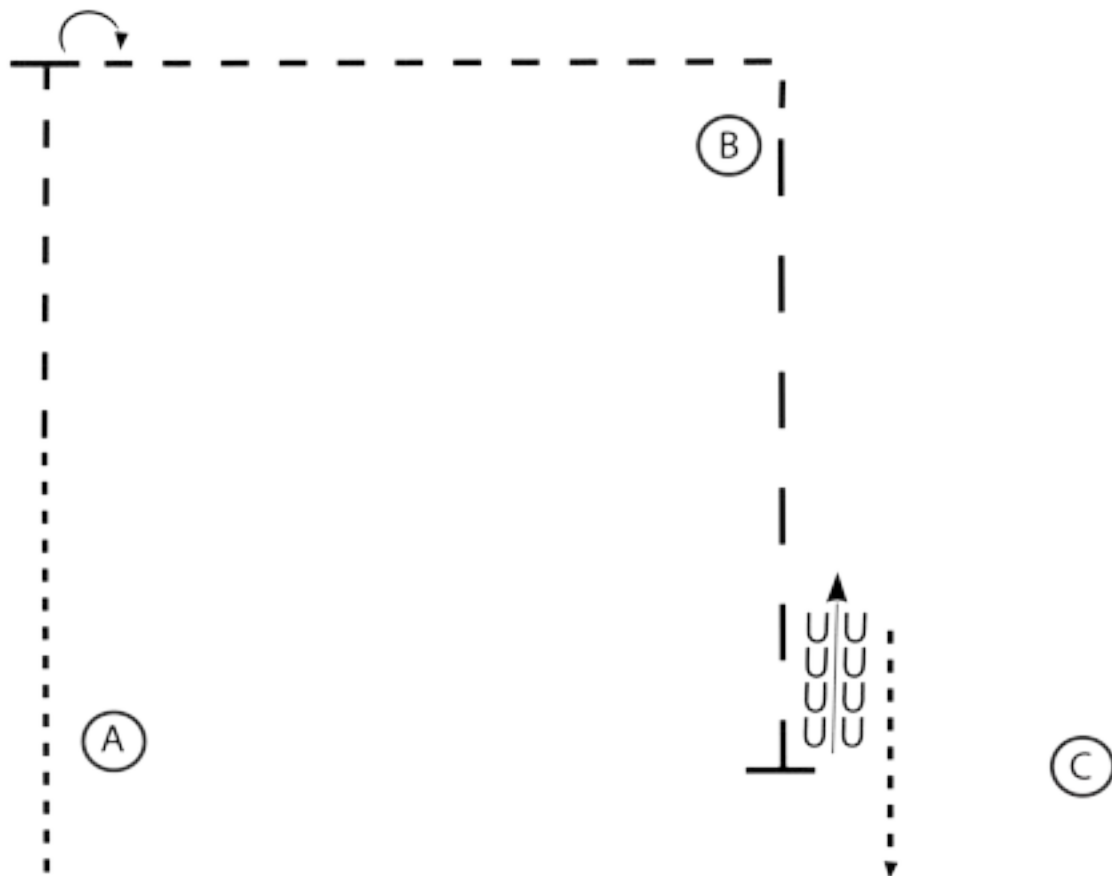

1. Walk to A
2. At A walk to center of the pattern
3. Jog until just past B and stop
4. Perform a 1/4 turn to the right
5. Jog to and around B
6. Extended jog until even with A and C
7. Stop and back approximately one horse length
8. Walk off straight past C
9. Pattern is over once you pass C at the walk.

Walk ······

Jog — — —

Extended Jog — —

Back ← 

Marker (A)

Pearl/Opal/Alumni Pattern 12

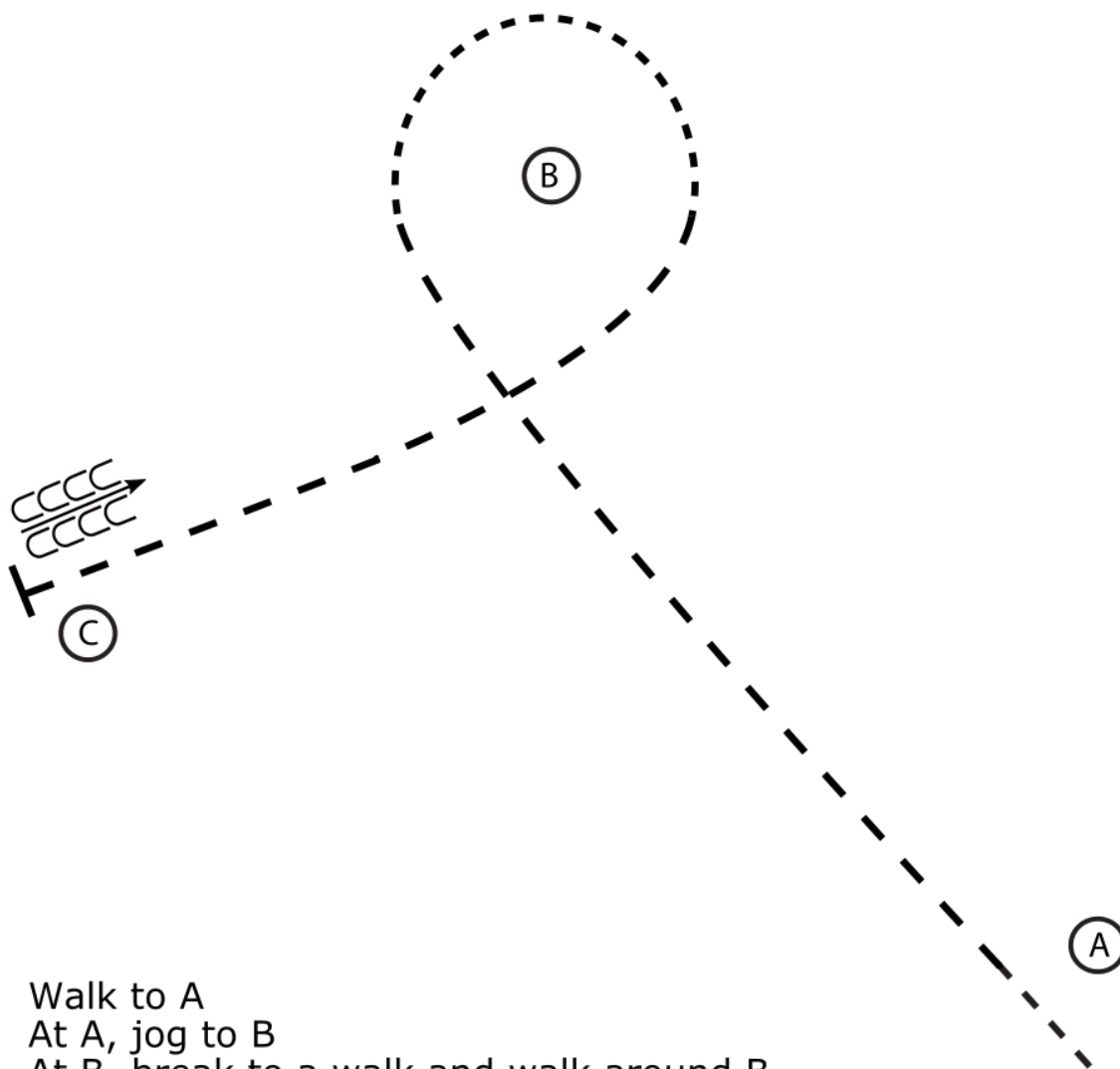

1. Walk to A
2. At A, jog to B
3. At B, break to a walk and walk around B
4. Jog to and around B to C
5. At C, stop
6. Back approximately one horse length.

Walk ······

Jog - - -

Extended Jog — —

Back ←

Marker Ⓐ

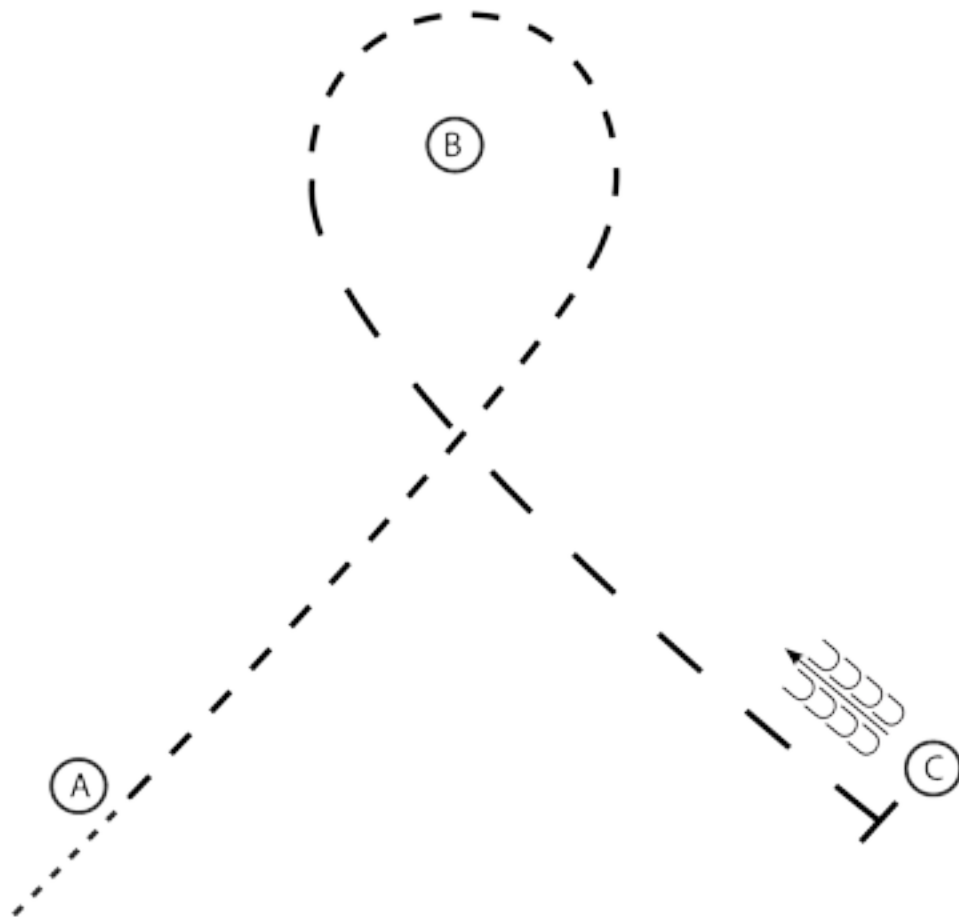

1. Walk to A
2. At A, jog to B
3. Jog around B
4. Extend the jog at B to C
5. At C, stop and back 4 steps.

Walk ······

Jog - - -

Extended Jog — —

Back ← 

Marker (A)

Pearl/Opal/Alumni Pattern 14

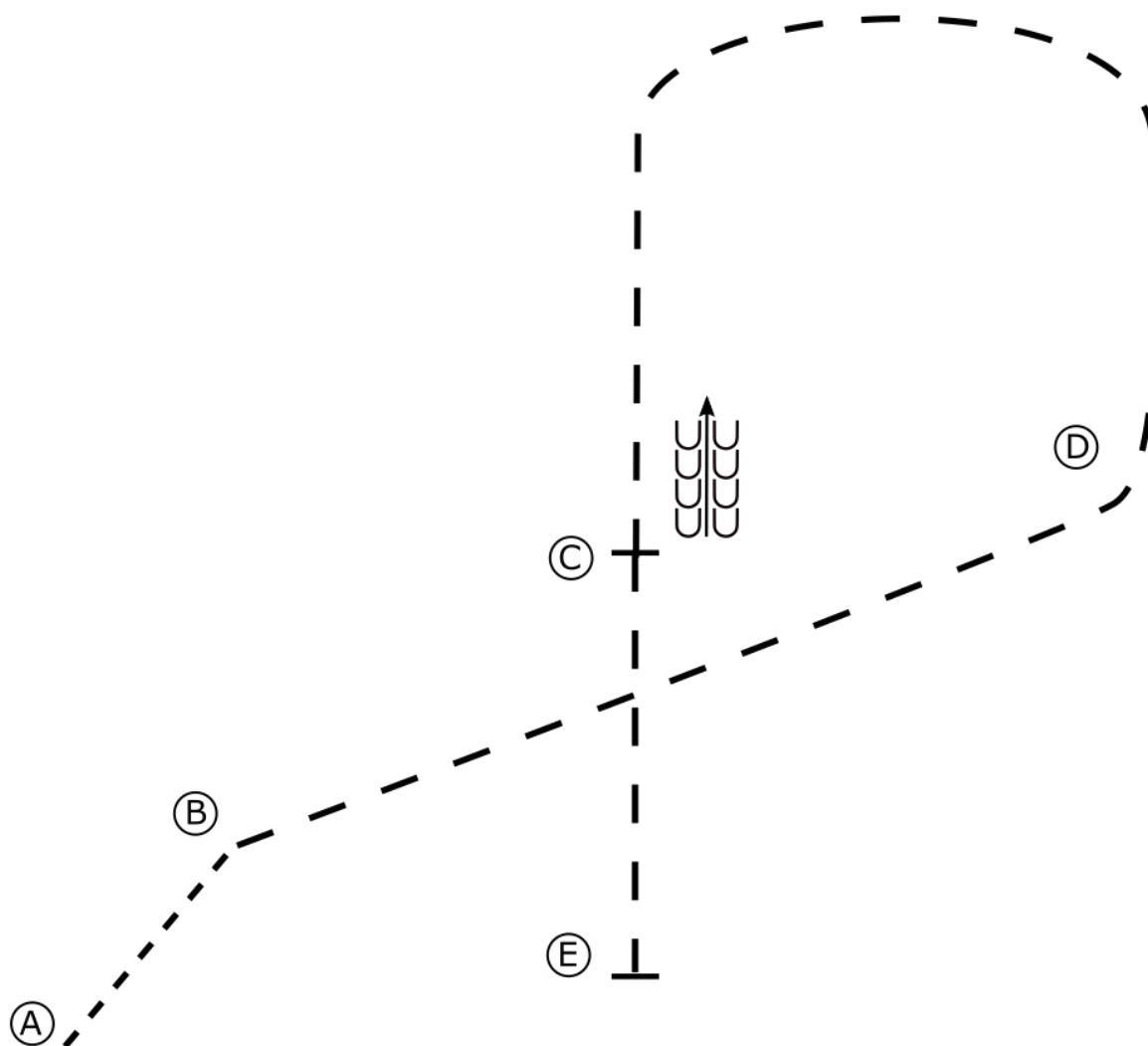

1. Walk to A
2. Walk from A to B
3. Jog from B to D
4. Jog around D to C
5. At C, stop and back 4 steps
6. Jog from C to E
7. At E, stop.

Walk ······

Jog - - -

Extended Jog — —

Back ← 

Marker (A)

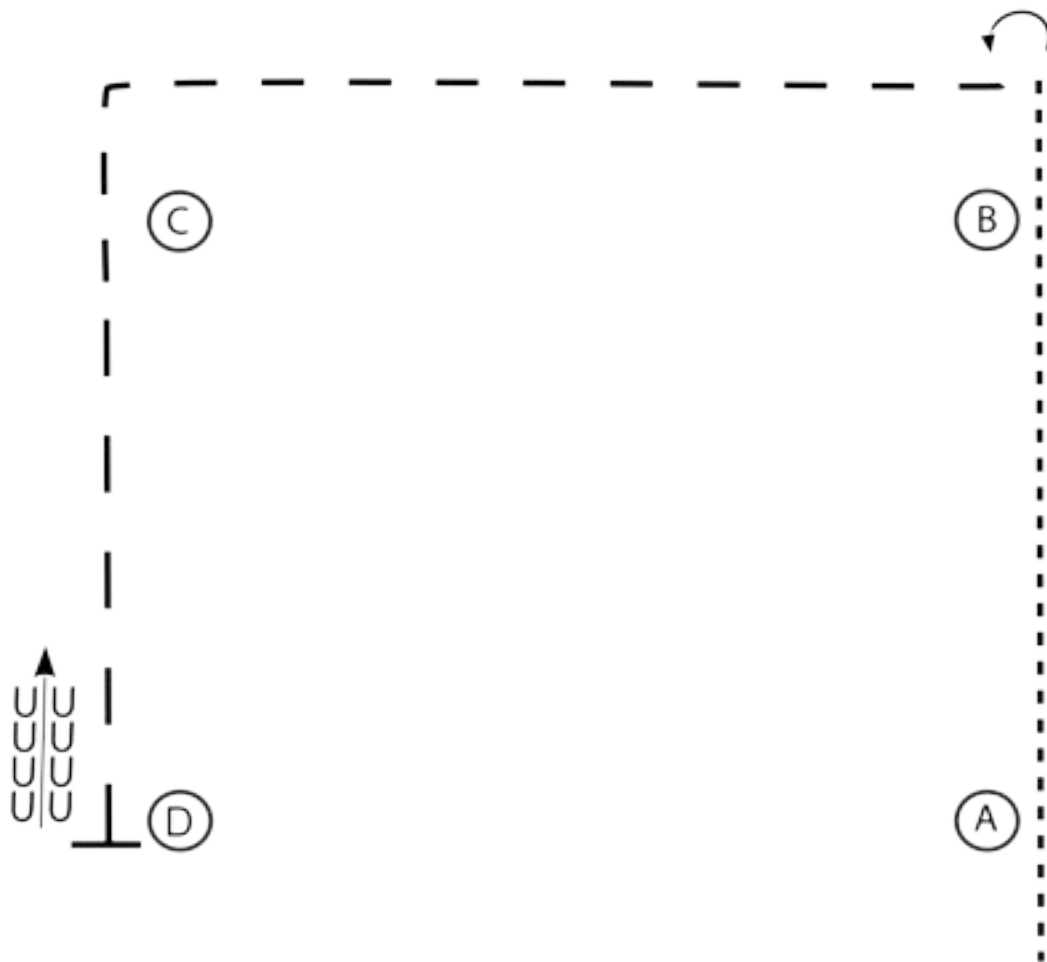

1. Walk to A
2. Walk from A to B
3. Stop past B and execute a 90 degree turn to the left
4. Jog from B around C
5. Extend the jog from C to D
6. Stop at D and back one horse length

Exit at the jog.

Walk ······

Jog - - -

Extended Jog — —

Back ← 

Marker Ⓐ

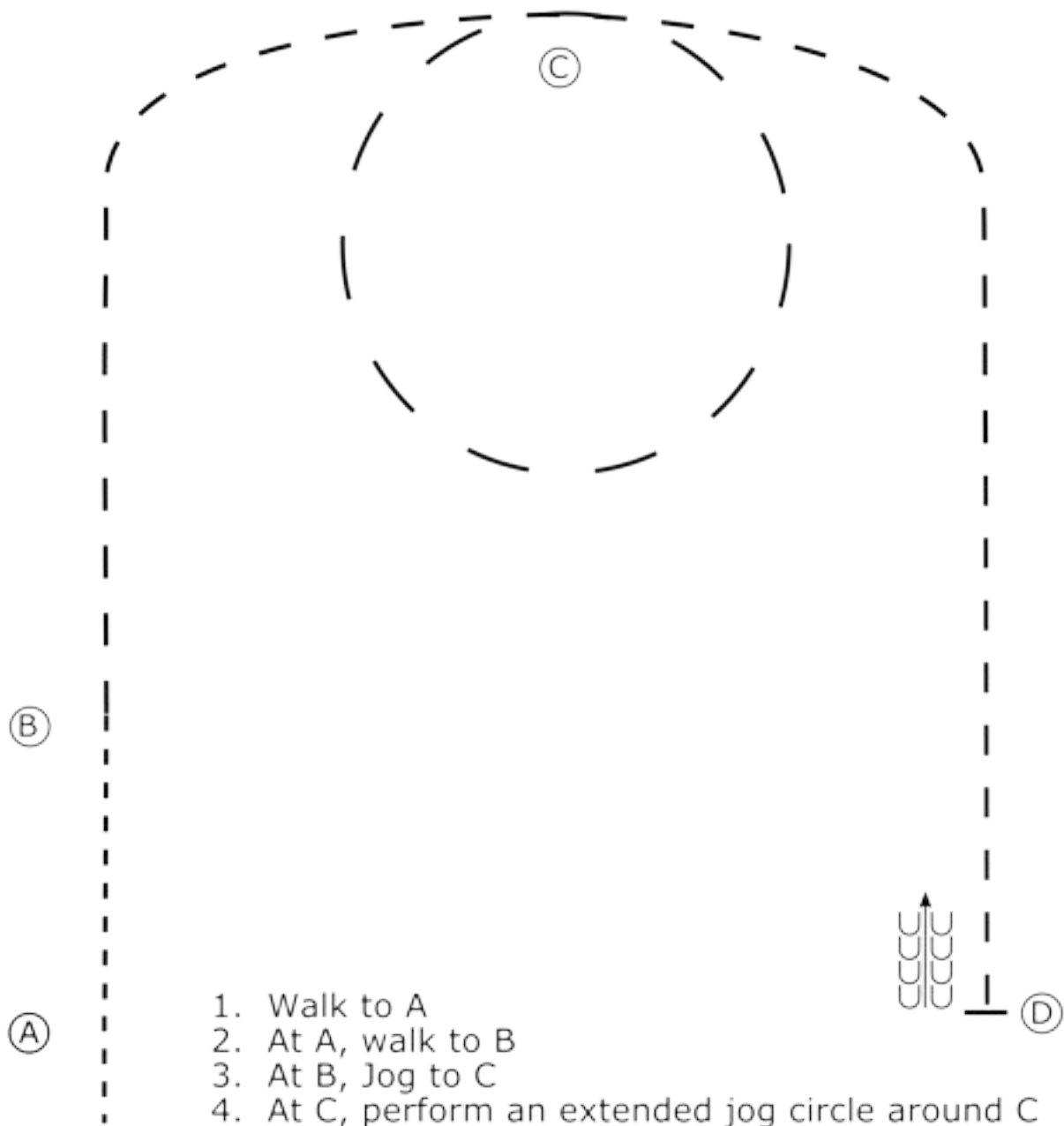

1. Walk to A
2. At A, walk to B
3. At B, Jog to C
4. At C, perform an extended jog circle around C
5. At C, return to the normal jog
6. Jog to D
7. At D, stop and back one horse length.

Walk ······

Jog - - -

Extended Jog — —

Back ← 

Marker (A)

Pearl/Opal/Alumni Pattern A

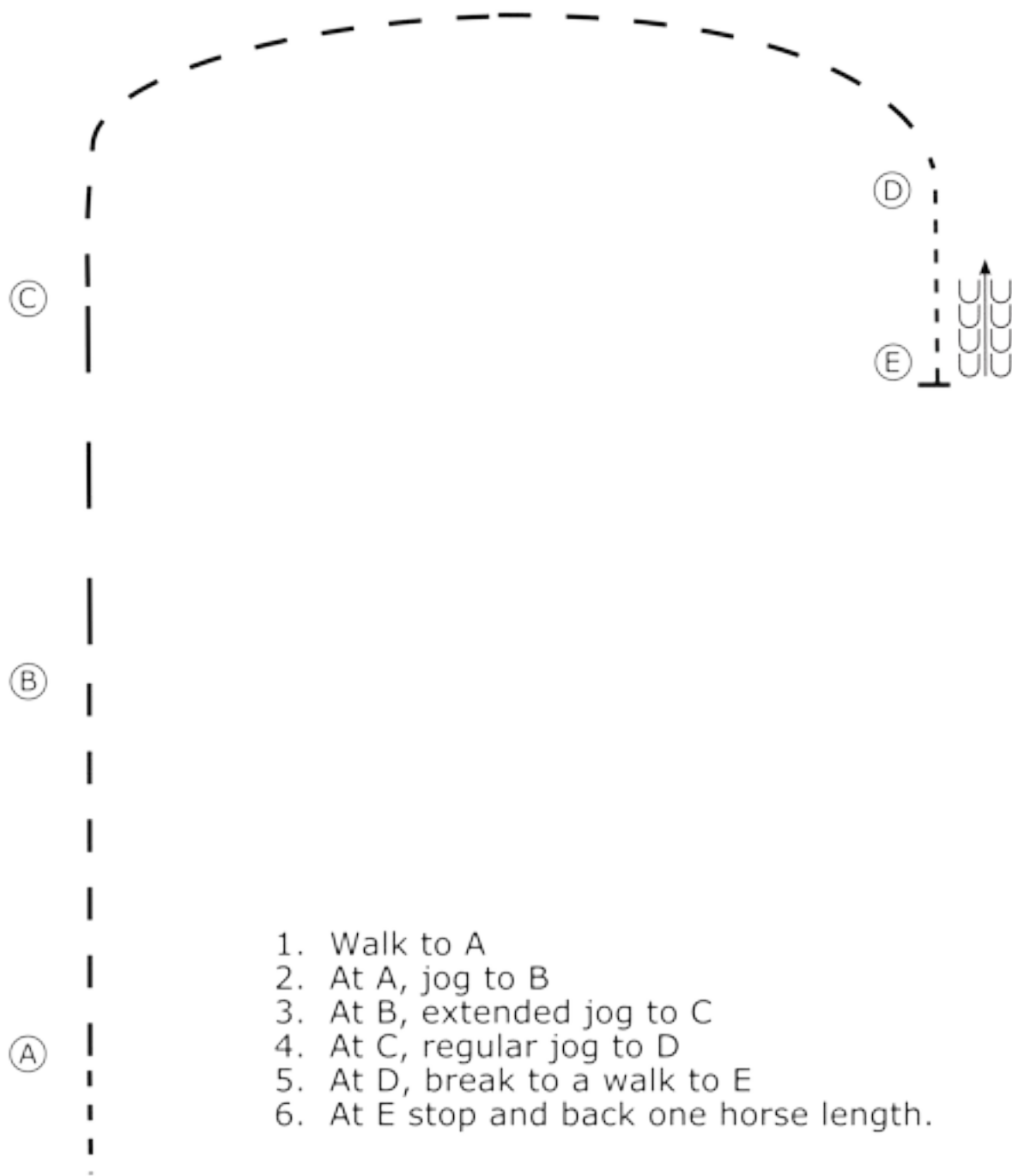

1. Walk to A
2. At A, jog to B
3. At B, extended jog to C
4. At C, regular jog to D
5. At D, break to a walk to E
6. At E stop and back one horse length.

Walk
 Jog - - -
 Extended Jog — —
 Back ← 
 Marker (A)

Pearl/Opal/Alumni Pattern B

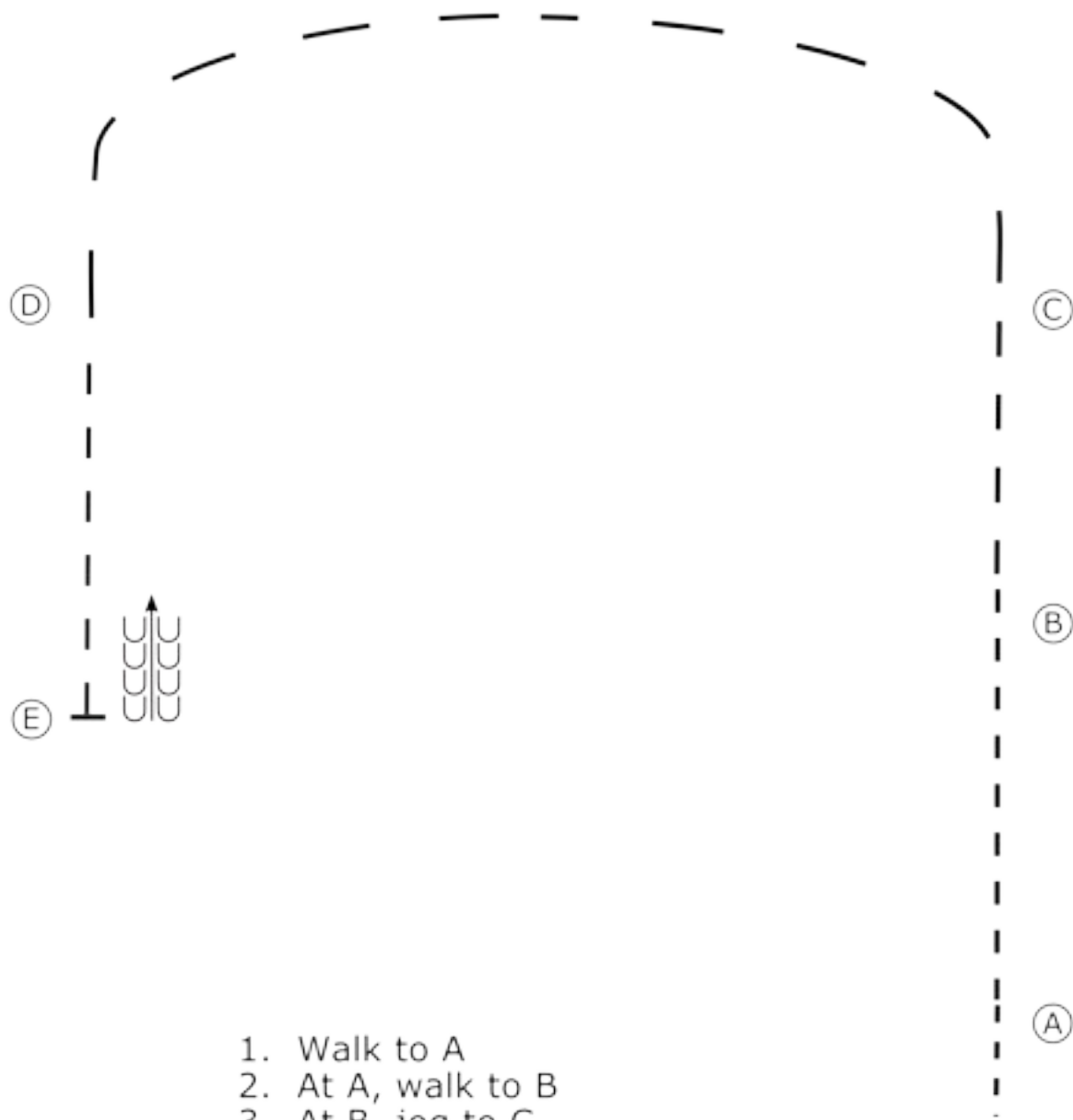

1. Walk to A
2. At A, walk to B
3. At B, jog to C
4. At C, extended jog to D
5. At D, regular jog to E
6. At E, stop and back one horse length.

Walk
 Jog - - -
 Extended Jog — —
 Back ← 
 Marker (A)

Emerald/Alumni Pattern 1

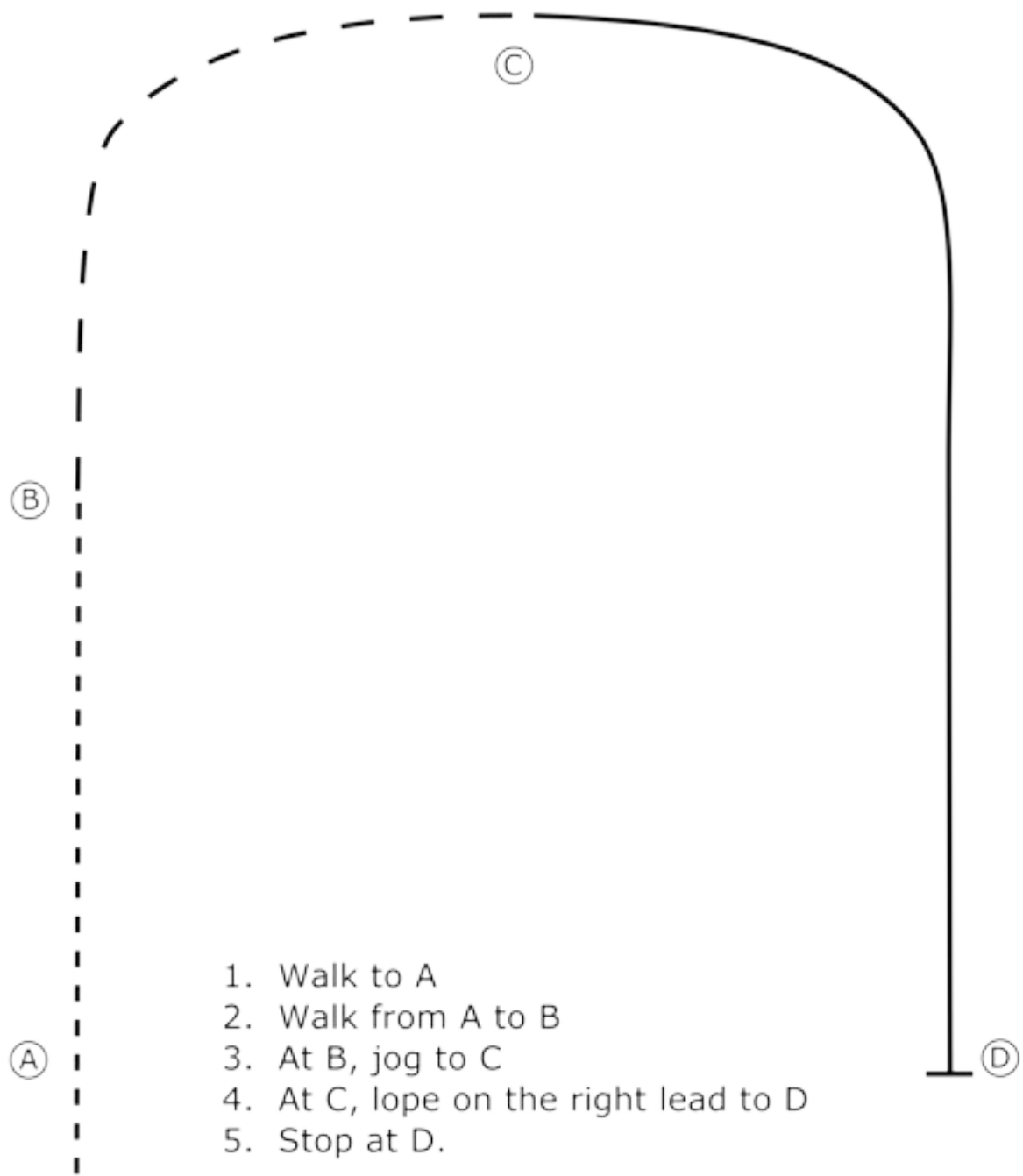

1. Walk to A
2. Walk from A to B
3. At B, jog to C
4. At C, lope on the right lead to D
5. Stop at D.

Walk
Jog - - -
Extended Jog — — —
Lope —————
Back ← 
Marker (A)

Emerald/Alumni Pattern 2

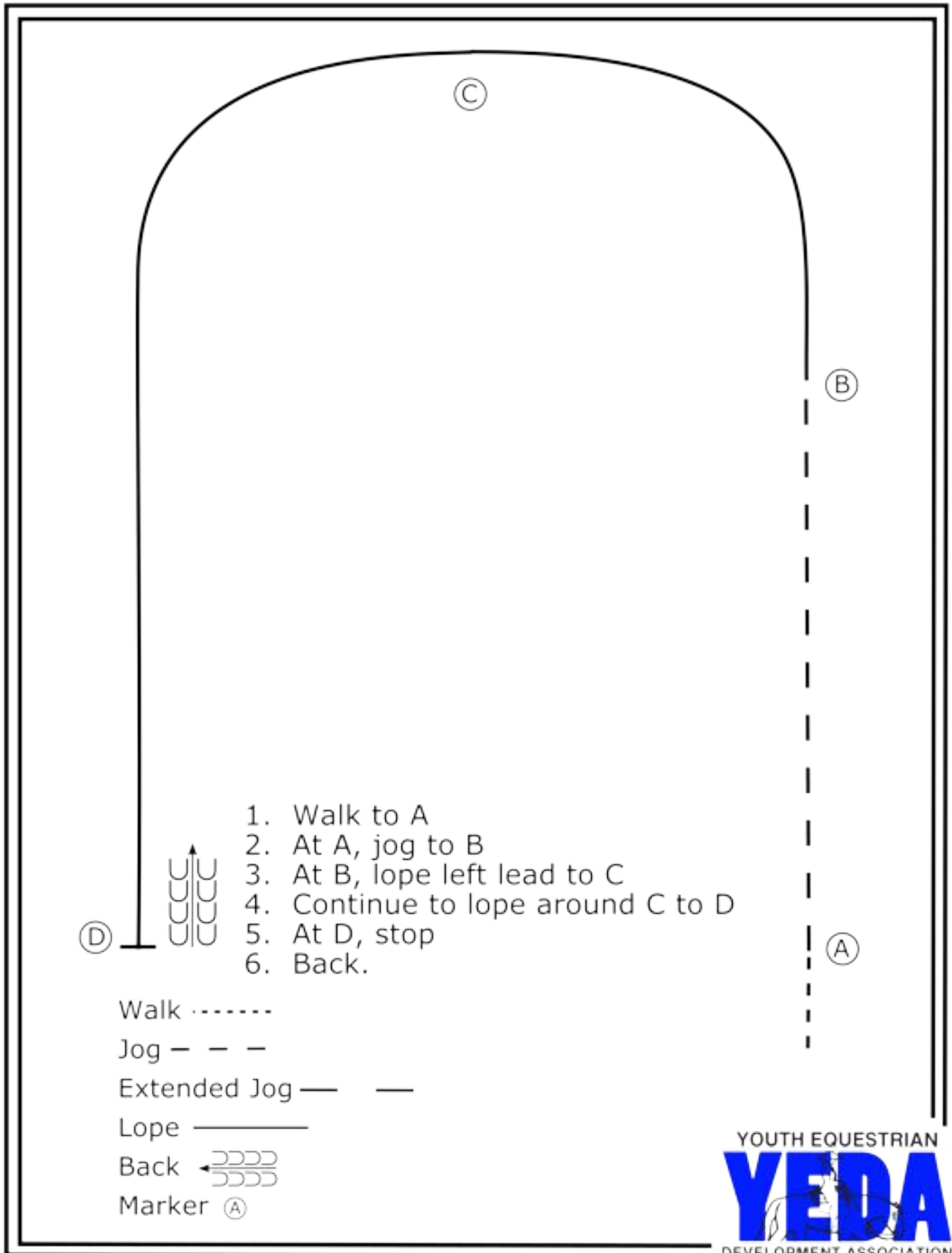

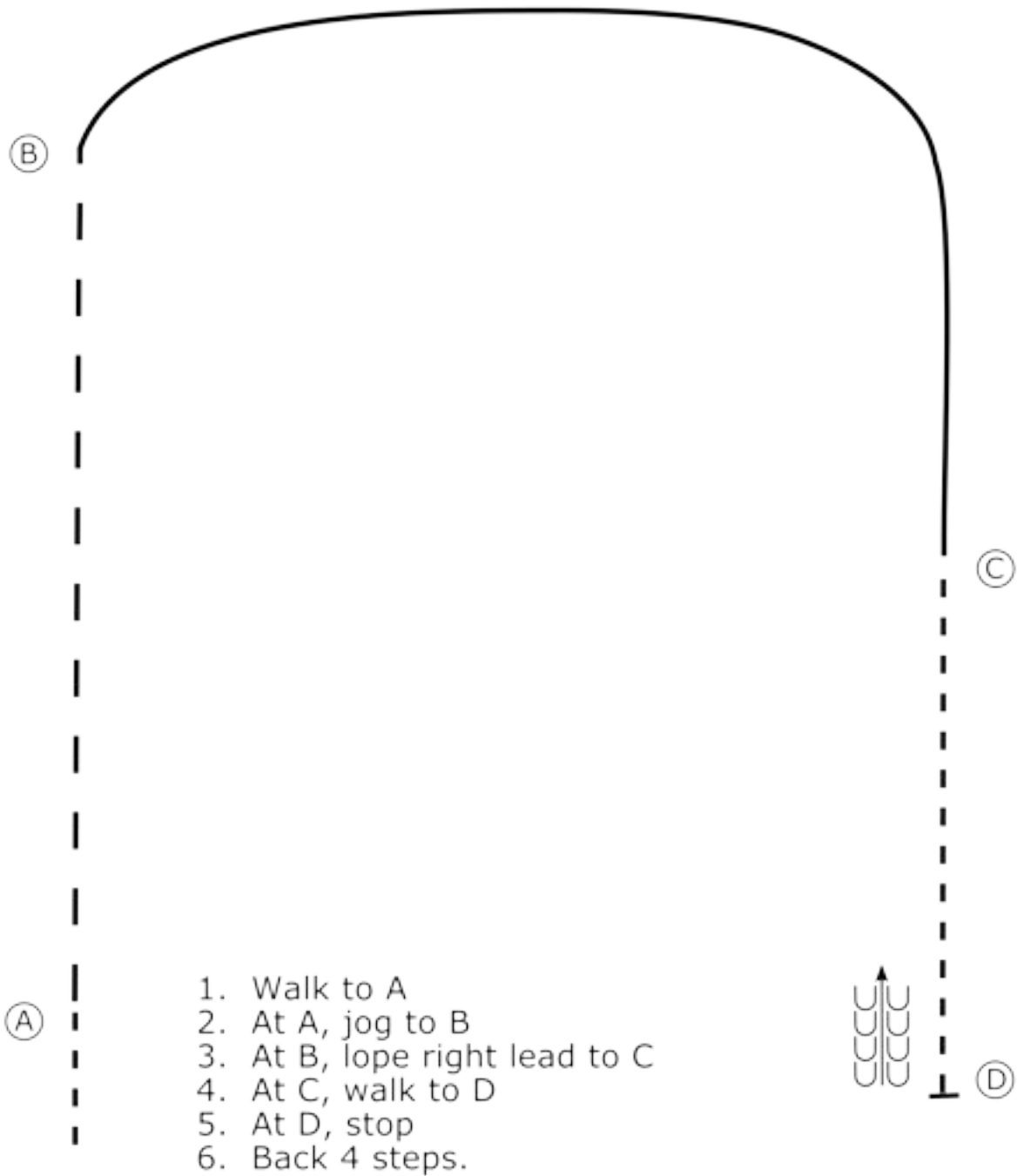

Emerald/Alumni Pattern 3

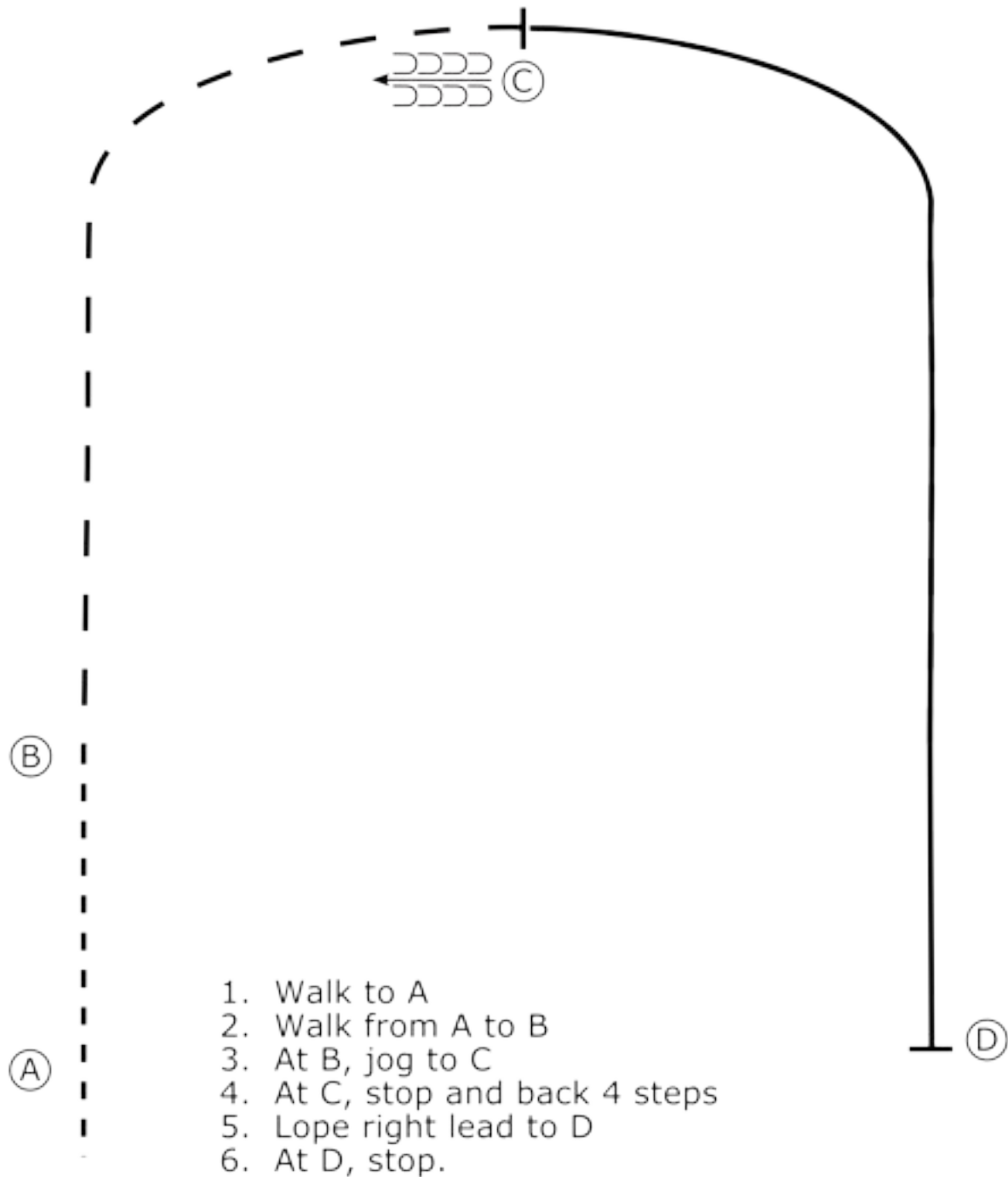

Walk
 Jog - - -
 Extended Jog — —
 Lope —————
 Back ← 
 Marker (A)

Emerald/Alumni Pattern 4



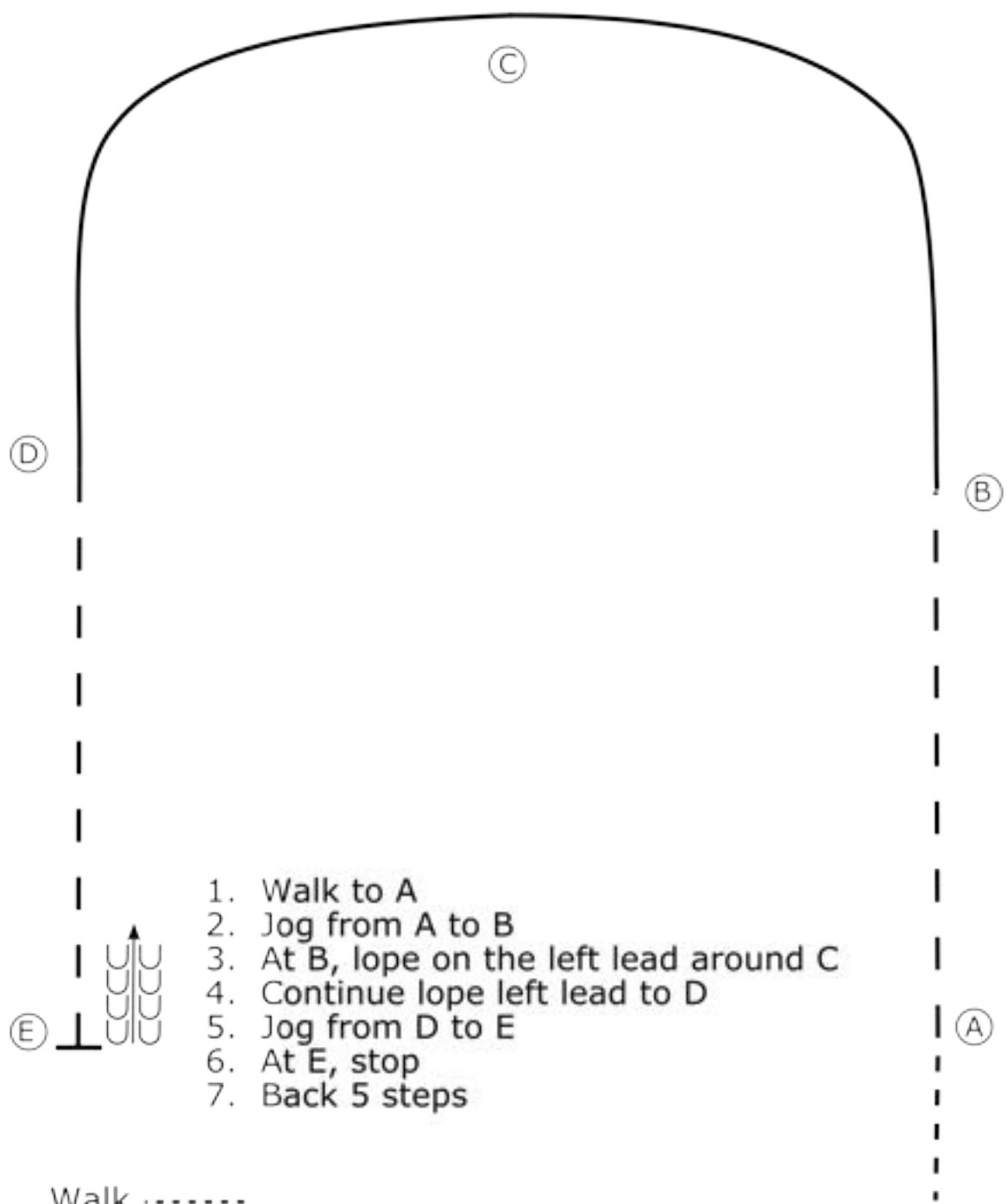

Walk
 Jog - - -
 Extended Jog — —
 Lope —————
 Back ← 
 Marker (A)

Emerald/Alumni Pattern 5

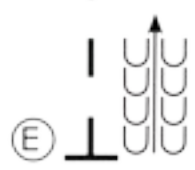

1. Walk to A
2. Jog from A to B
3. At B, lope on the left lead around C
4. Continue lope left lead to D
5. Jog from D to E
6. At E, stop
7. Back 5 steps



Walk
 Jog - - -
 Extended Jog — —
 Lope —————
 Back ← 
 Marker (A)

Emerald/Alumni Pattern 6

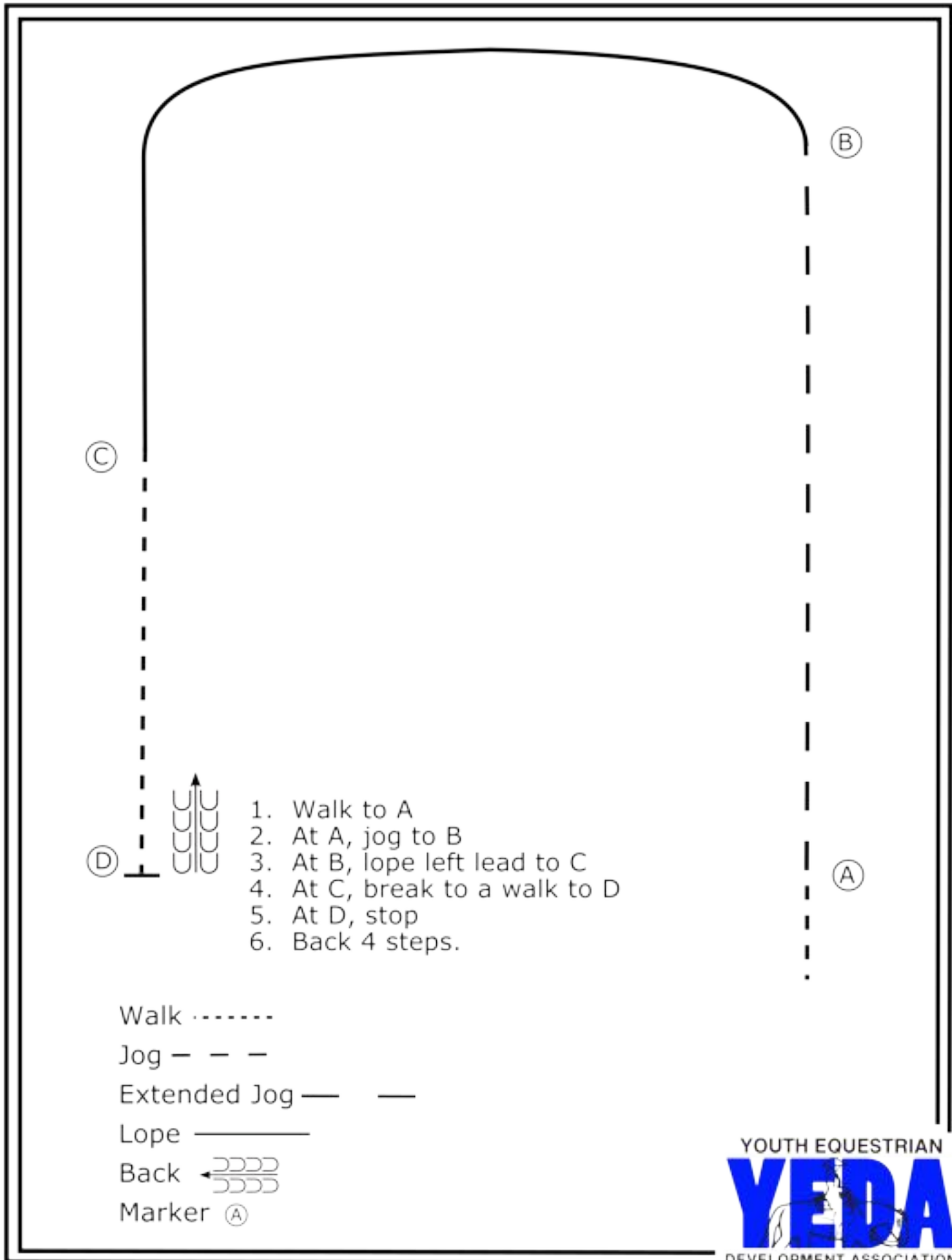

Emerald/Alumni Pattern 7

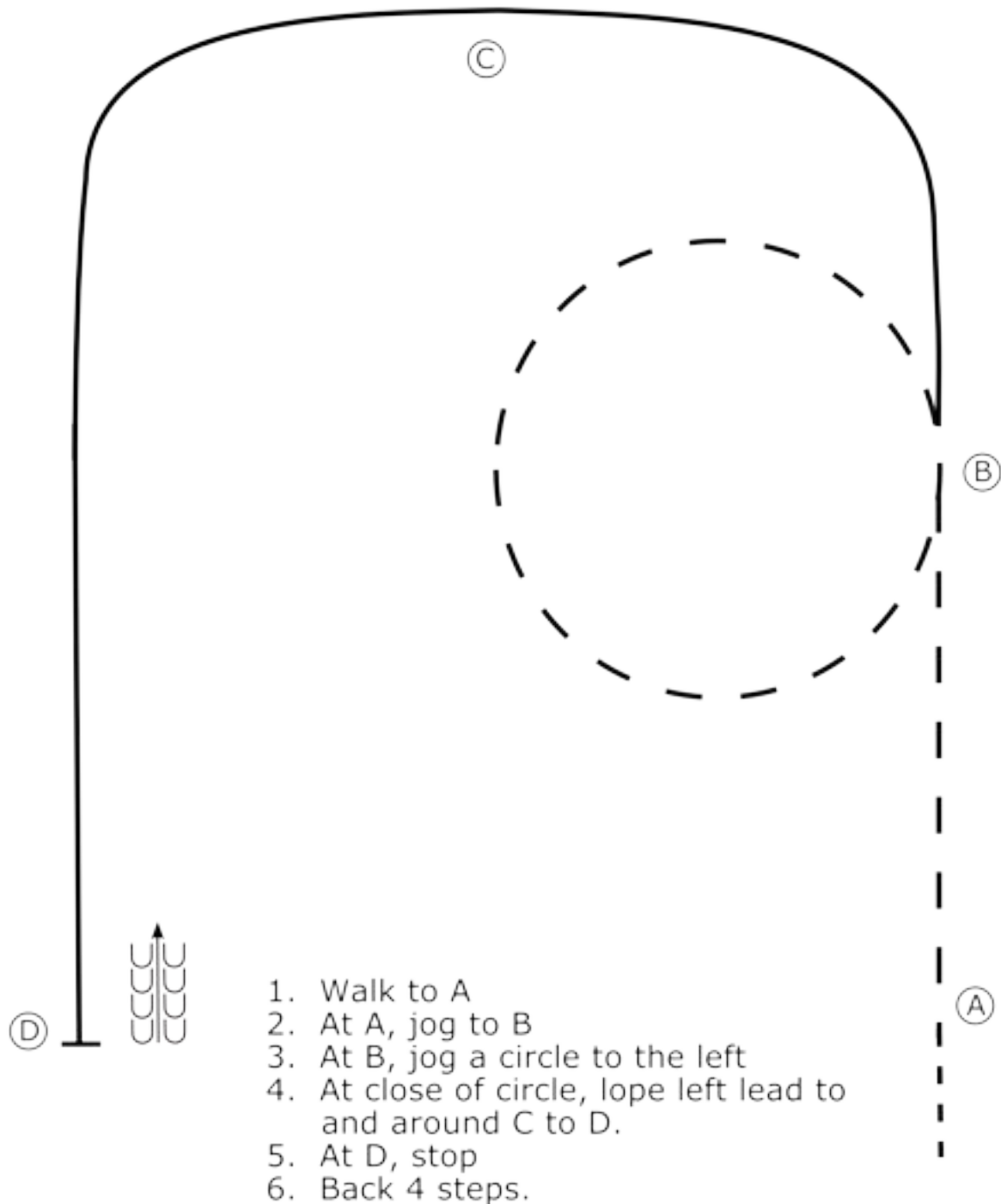

1. Walk to A
2. At A, jog to B
3. At B, jog a circle to the left
4. At close of circle, lope left lead to and around C to D.
5. At D, stop
6. Back 4 steps.

Walk ······

Jog - - -

Extended Jog — —

Lope —————

Back ←

Marker (A)

Emerald/Alumni Pattern 8

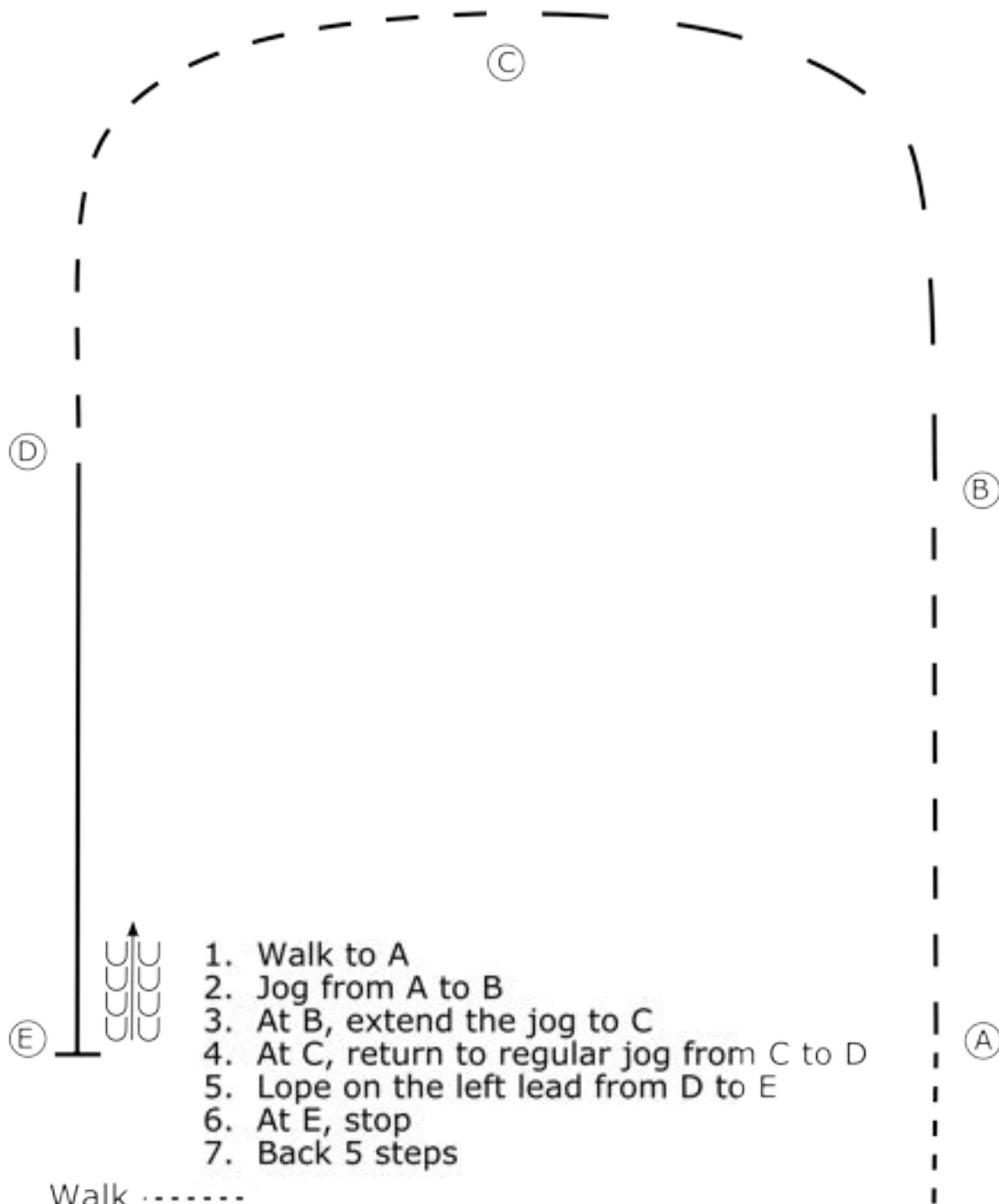

1. Walk to A
2. Jog from A to B
3. At B, extend the jog to C
4. At C, return to regular jog from C to D
5. Lope on the left lead from D to E
6. At E, stop
7. Back 5 steps

Walk ······

Jog - - -

Extended Jog — —

Lope —————

Back ←

Marker (A)

Emerald/Alumni Pattern 10

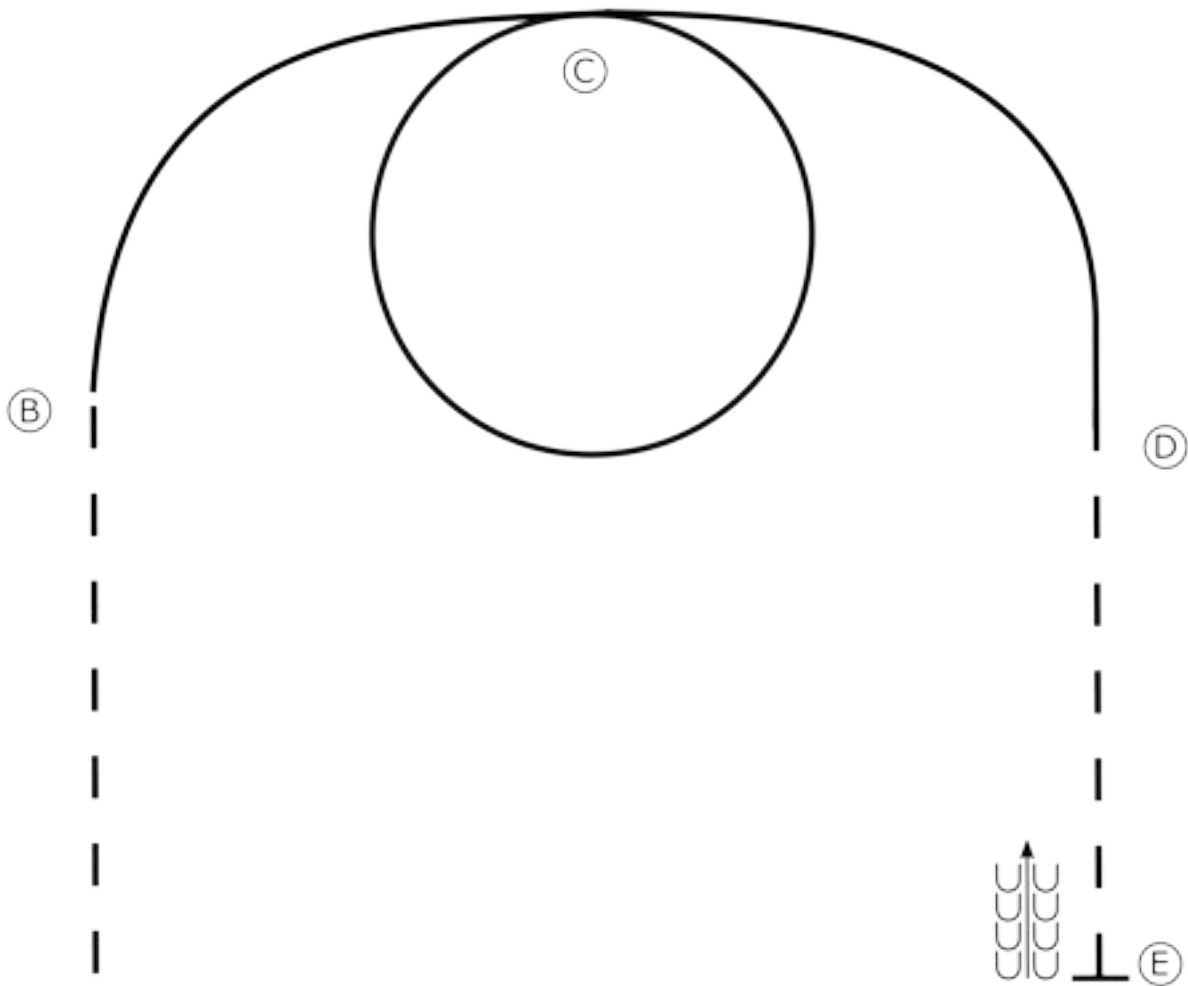

1. Walk to A
2. At A, jog to B
3. At B, lope on the right lead to C
4. At C, lope a circle to the right around C to D
5. At D, break to a jog.
6. At E, stop
7. Back one horse length.

Walk ······

Jog - - -

Extended Jog — —

Lope —————

Back ←

Marker (A)

Emerald/Alumni Pattern 11

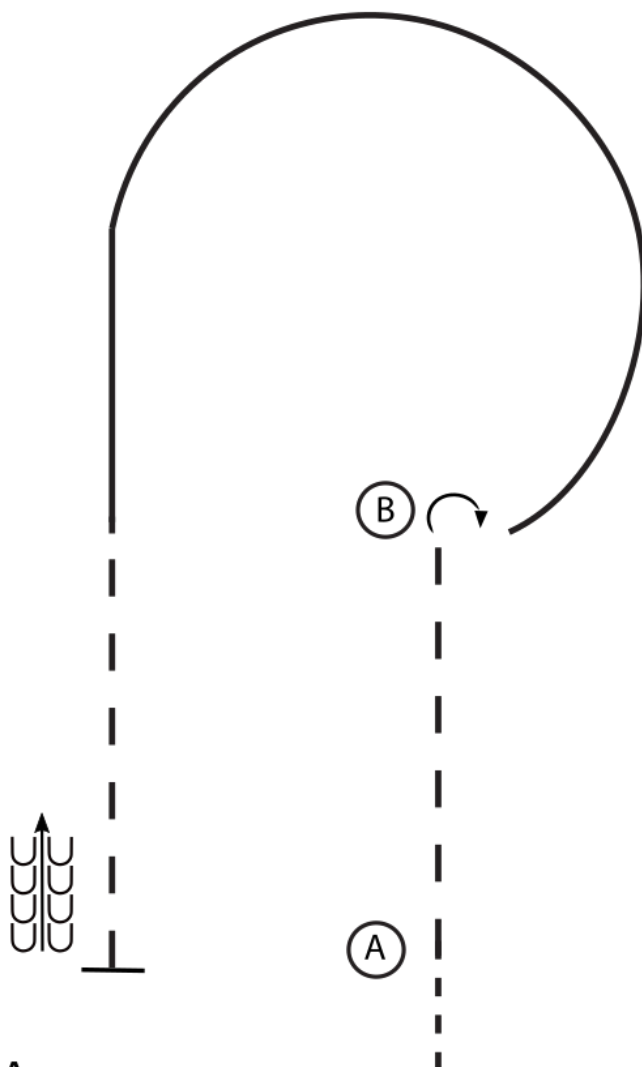

1. Walk to A
2. Jog from A to B
3. At B, stop and perform a 90 degree turn to the right
4. Lope a circle around B on the left lead
5. When even with B, break to a jog until even with A
6. Stop when even with A
7. Back one horse length.

Walk ······

Jog - - -

Extended Jog — —

Lope —————

Back ← 

Marker (A)

Emerald/Alumni Pattern 12

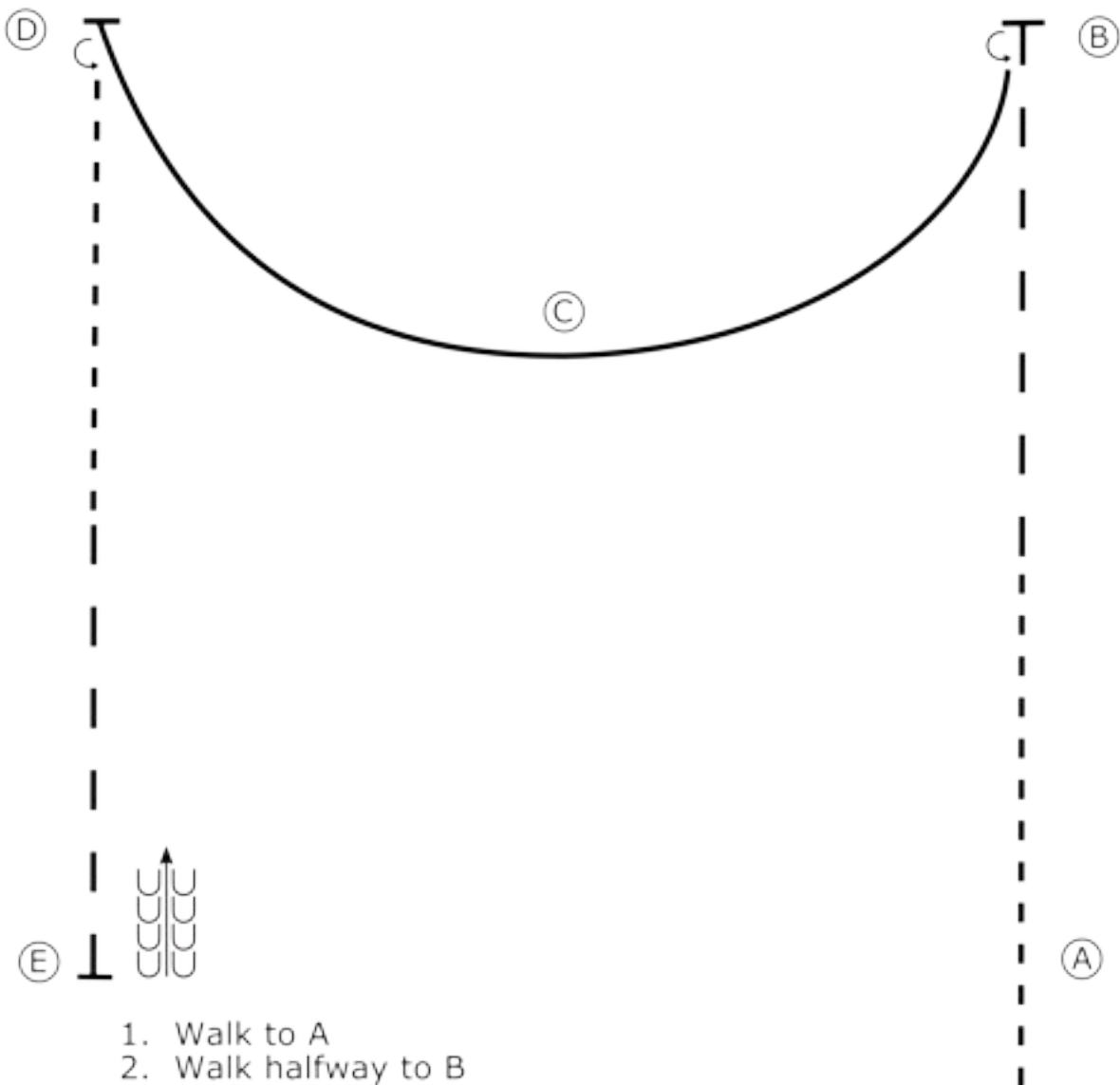

1. Walk to A
2. Walk halfway to B
3. At halfway mark, jog to B
4. Stop and perform a 180 degree turn to the left.
5. Lope on the right lead half circle around C and to D
6. Stop and perform a 180 degree turn to the left
7. Walk halfway to E
8. Jog to E and stop
9. Back approximately one horse length..

Walk ······

Jog - - -

Extended Jog — —

Lope —————

Back ←

Marker (A)

Emerald/Alumni Pattern 13

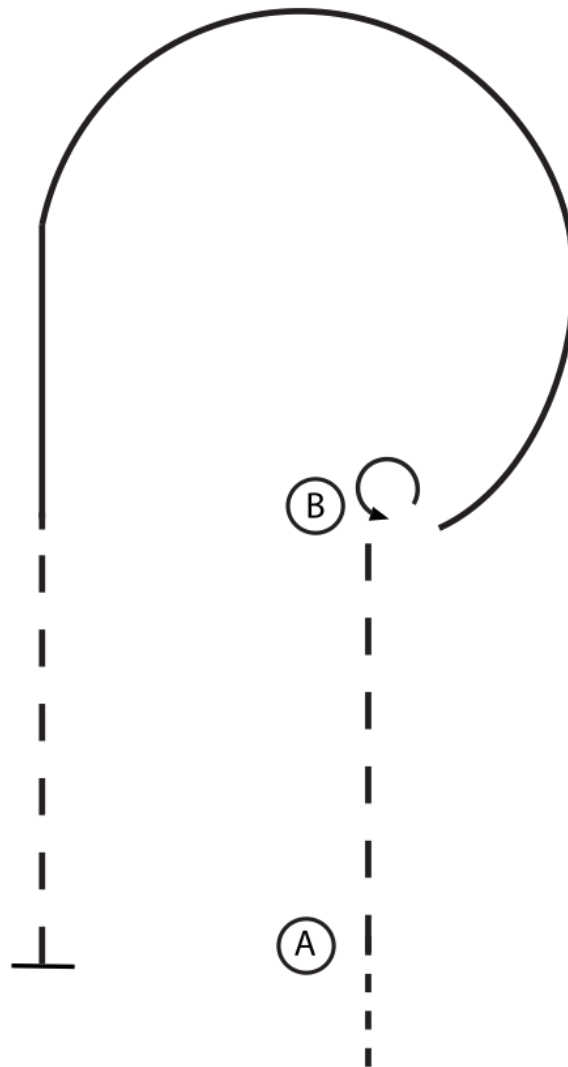

1. Walk to A
2. Jog from A to B
3. At B, stop and perform a 270 degree turn to the left
4. Lope a circle around B on the left lead
5. When even with B, break to a jog until even with A
6. Stop when even with A.

Walk ······

Jog - - -

Extended Jog — —

Lope —————

Back ← 

Marker (A)

Emerald/Alumni Pattern 14

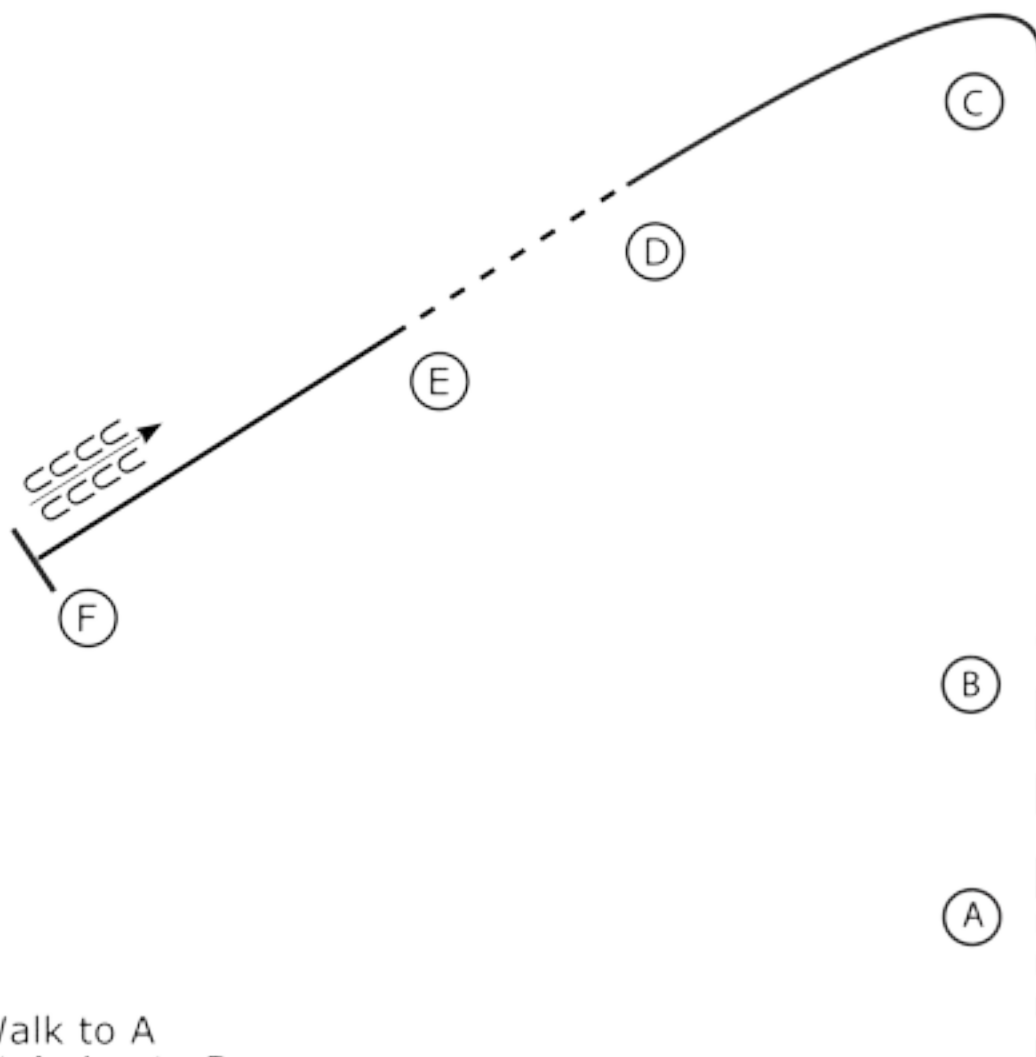

1. Walk to A
2. At A, jog to B
3. At B, Lope on the left lead around C to D
4. At D, walk to E
5. At E, lope on the right lead to F
6. Stop at F and back 4 steps.

Walk ······

Jog - - -

Extended Jog — — —

Lope —————

Back ←

Marker (A)

Emerald/Alumni Pattern 15

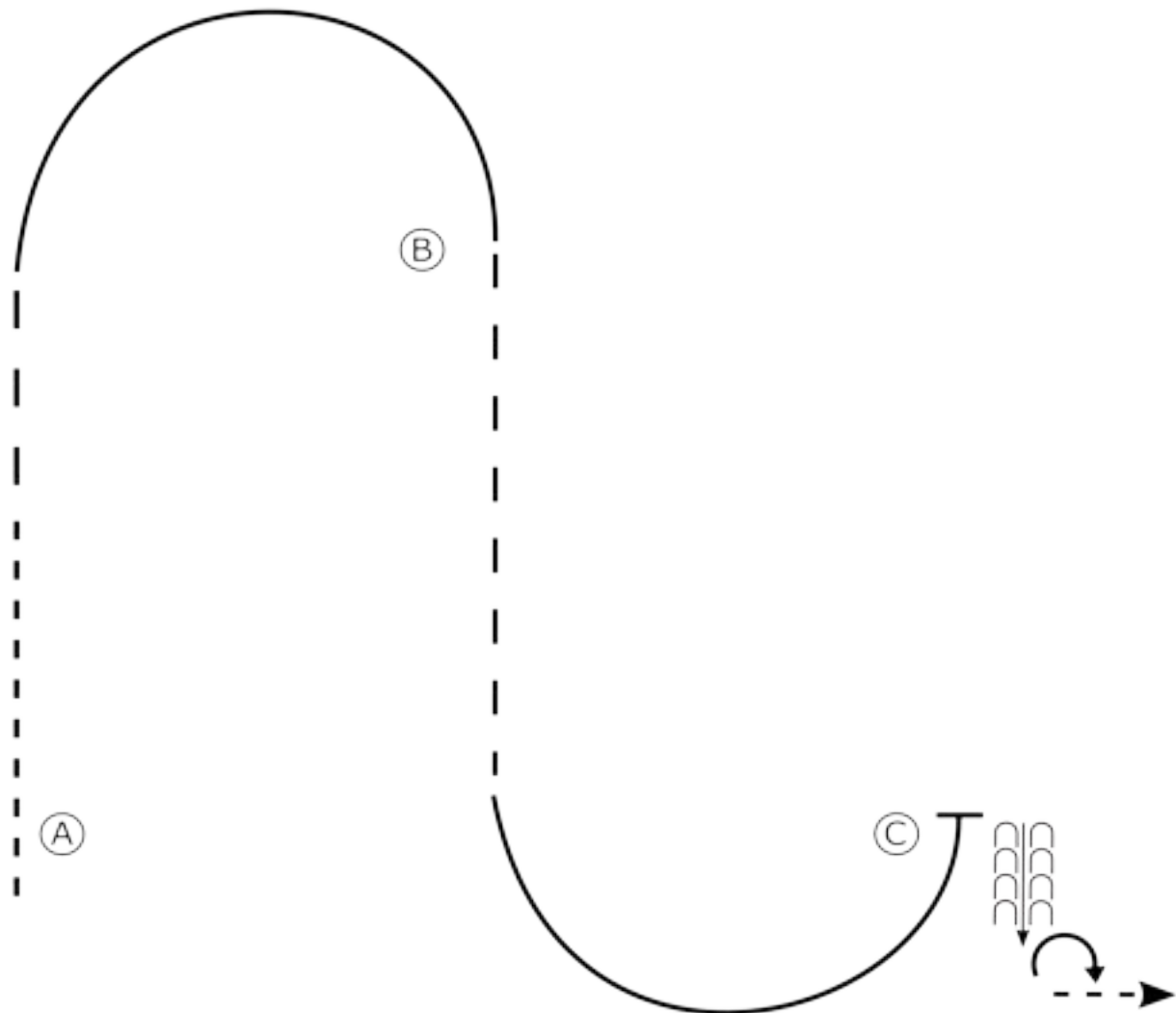

1. Walk to A
2. Walk from A to center of pattern
3. Jog until even with B
4. Lope a half circle on the right lead to and around B
5. Jog from B until even with C
6. Lope a half circle on the left lead to C
7. Stop at C and back approximately one horse length
8. Perform a 1/4 turn to the right and walk off.

Walk ······

Jog - - -

Extended Jog — —

Lope —————

Back ← 

Marker (A)

Emerald/Alumni Pattern 16

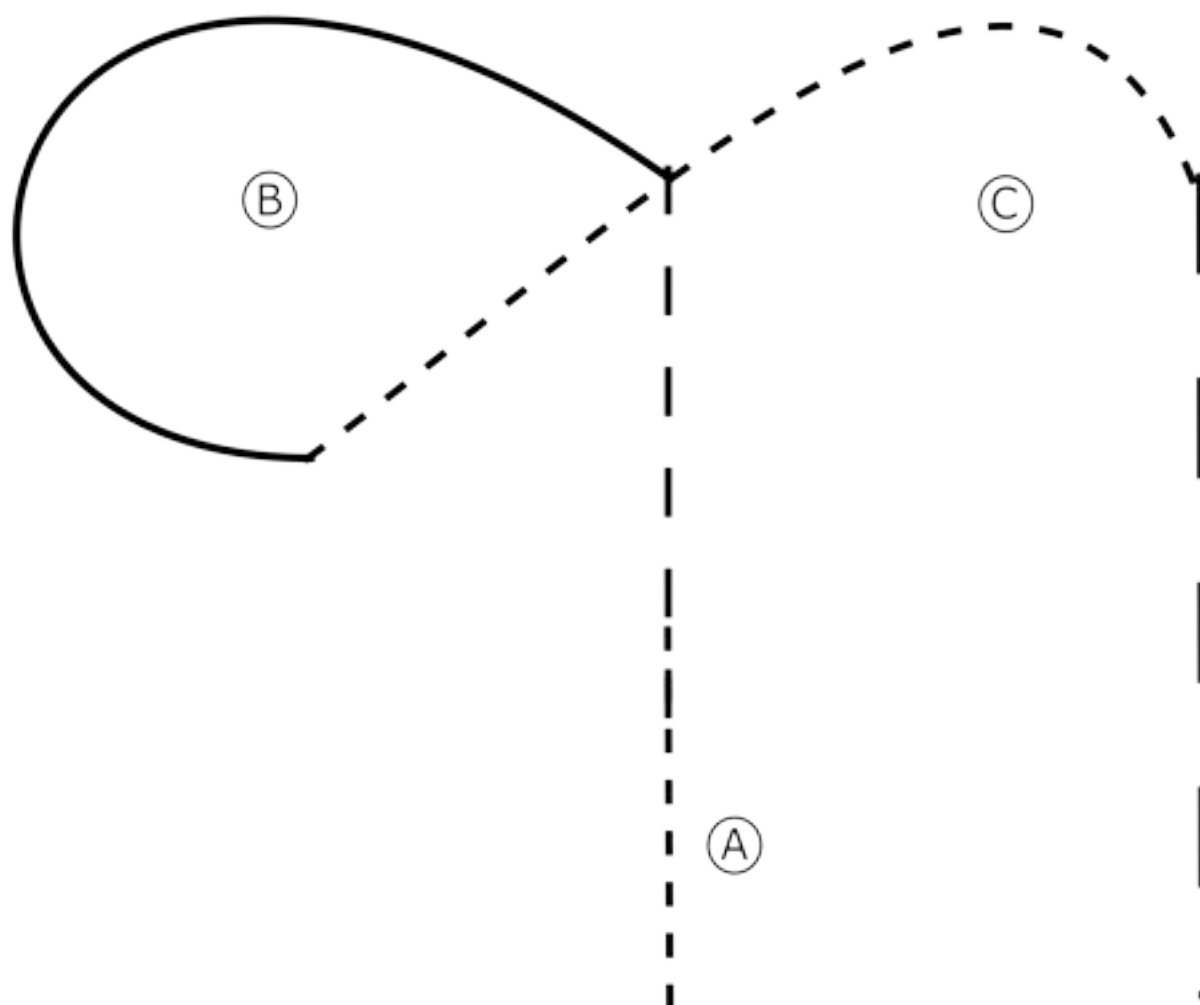

1. Walk to A
2. Jog until between B and C
3. Lope on the left lead around B and toward C
4. Jog to and around C
5. When even with C, extend the jog to exit
6. Pattern is over once you have passed A.

Walk ······

Jog - - -

Extended Jog — —

Lope —————

Back ← 

Marker (A)

Emerald/Alumni Pattern A

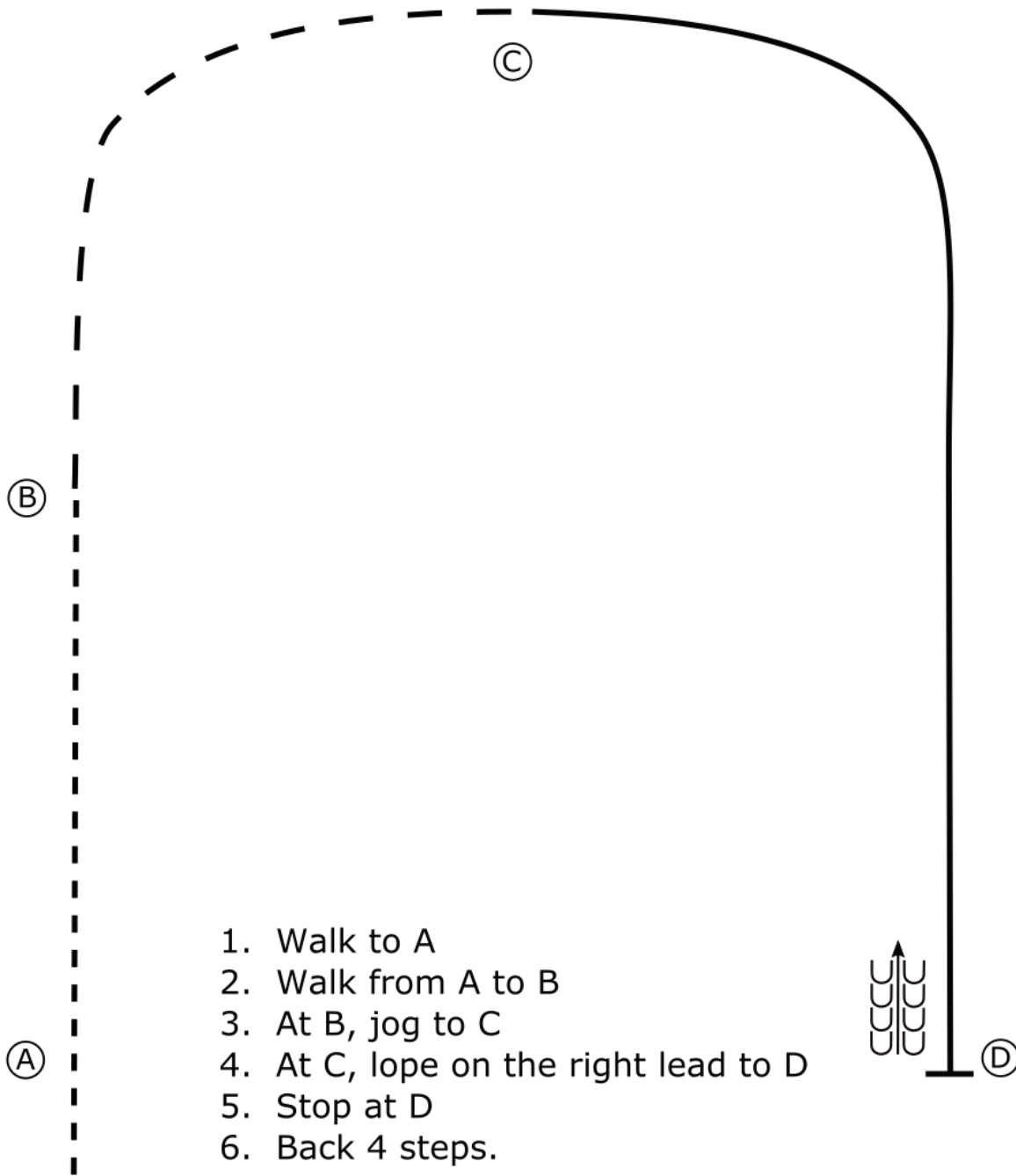

1. Walk to A
2. Walk from A to B
3. At B, jog to C
4. At C, lope on the right lead to D
5. Stop at D
6. Back 4 steps.

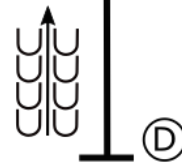

Walk
 Jog - - -
 Extended Jog — — —
 Lope —————
 Back ← 
 Marker (A)

Emerald/Alumni Pattern B

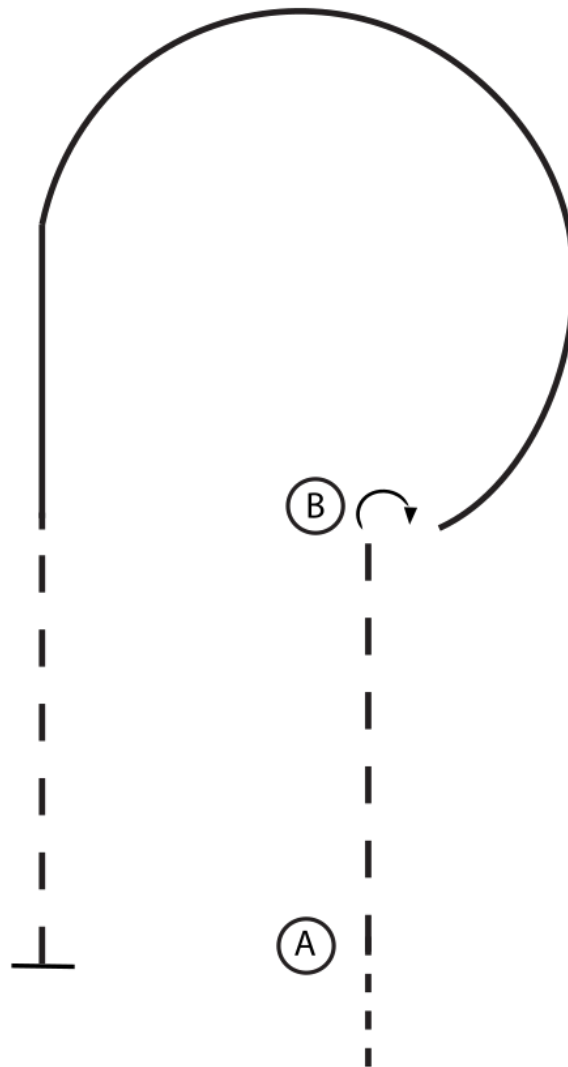

1. Walk to A
2. Jog from A to B
3. At B, stop and perform a 90 degree turn to the right
4. Lope a circle around B on the left lead
5. When even with B, break to a jog until even with A
6. Stop when even with A.

Walk ······

Jog - - -

Extended Jog — —

Lope —————

Back ← 

Marker (A)

Ruby Pattern 1

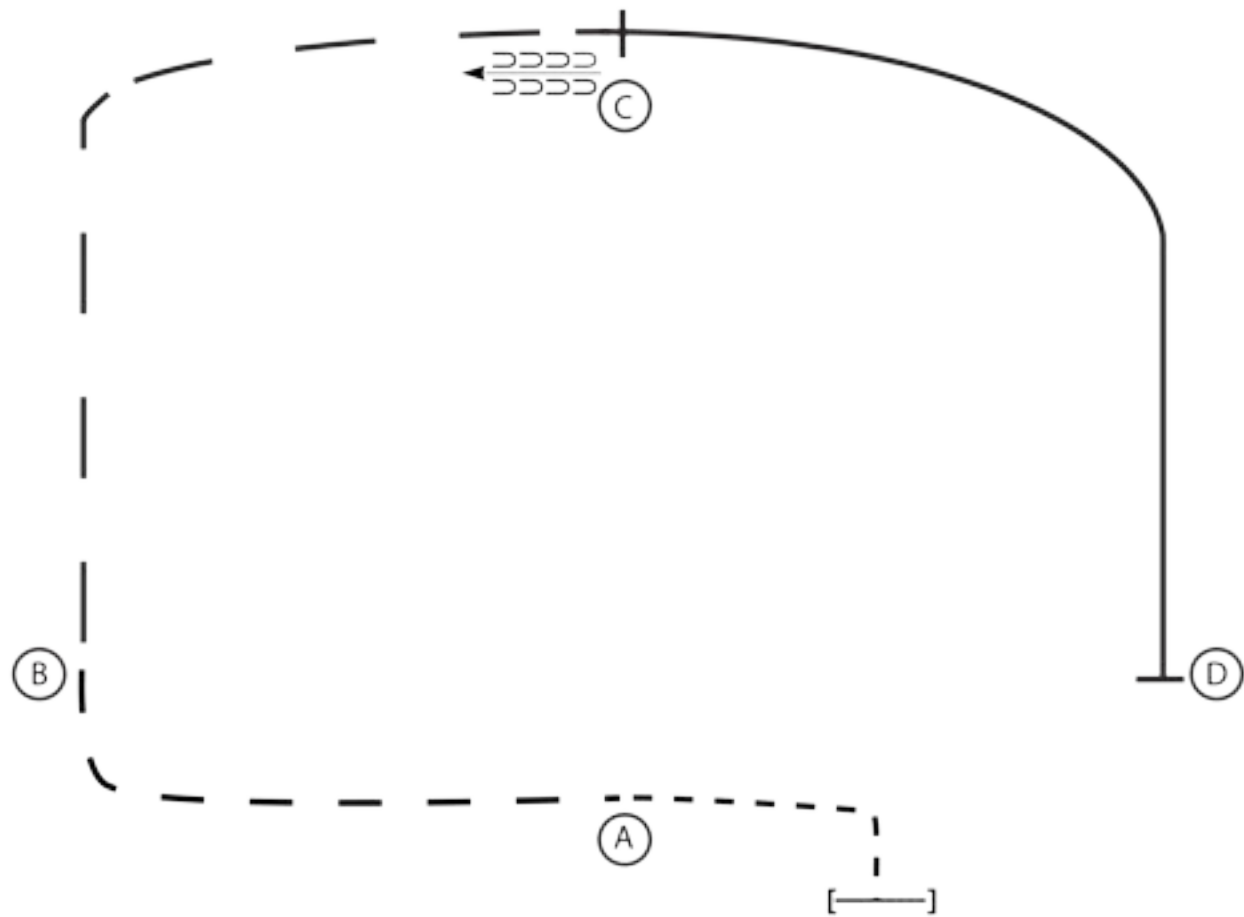

1. Walk to A
2. At A, jog to B
3. At B, extend the jog to C
4. At C, stop and back 5 steps
5. Lope right lead to D
6. Stop at D.

Walk

Jog - - -

Extended Jog — —

Lope —————

Back ← 

Marker (A)

Ruby Pattern 2

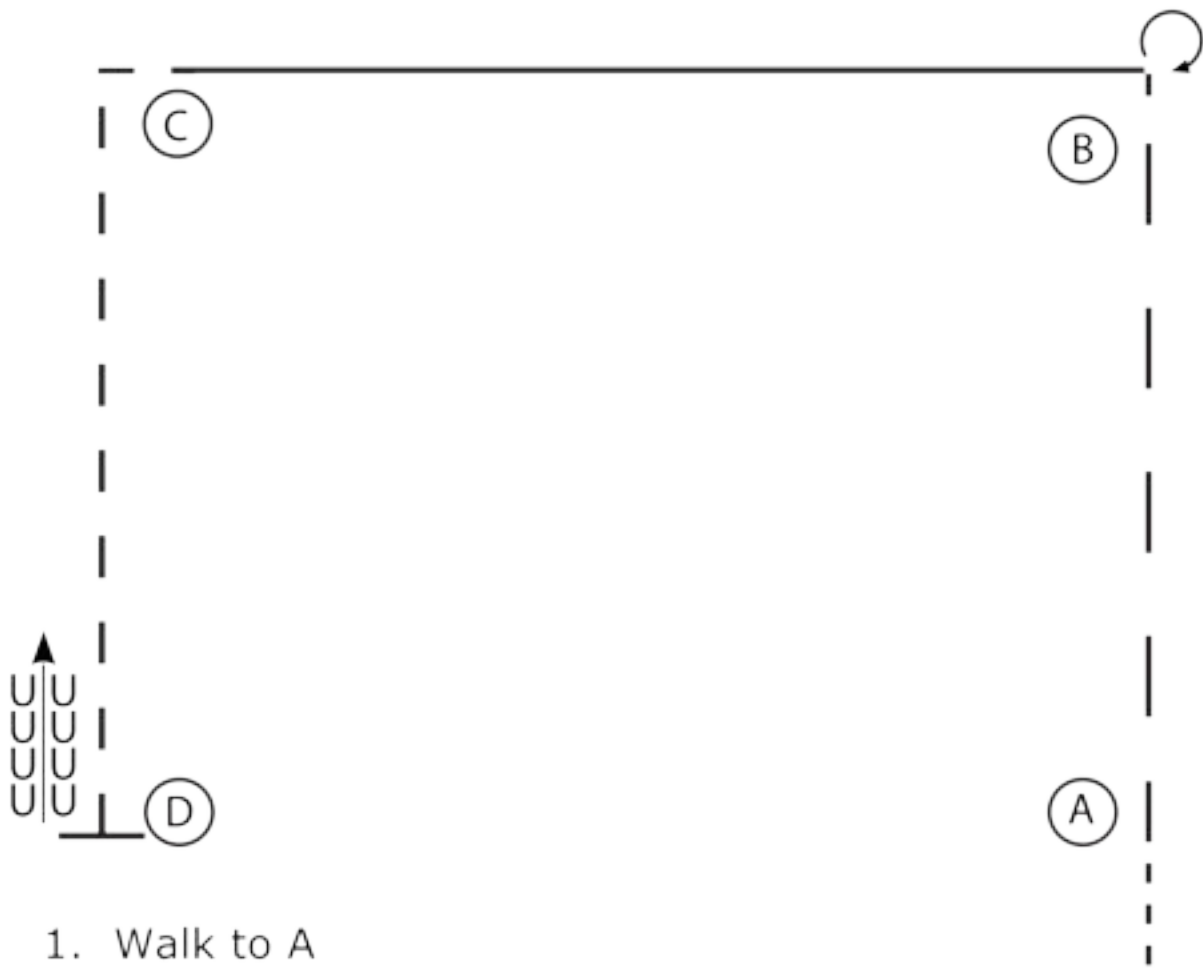

1. Walk to A
2. Extended jog from A past B
3. Stop and execute a 270 degree turn to the right
4. Lope right lead from B to C
5. Break to a jog from C to D
6. Stop at D and back one horse length

Exit at a jog

Walk ······

Jog - - -

Extended Jog — — —

Lope —————

Back ←

Marker (A)

Ruby Pattern 3

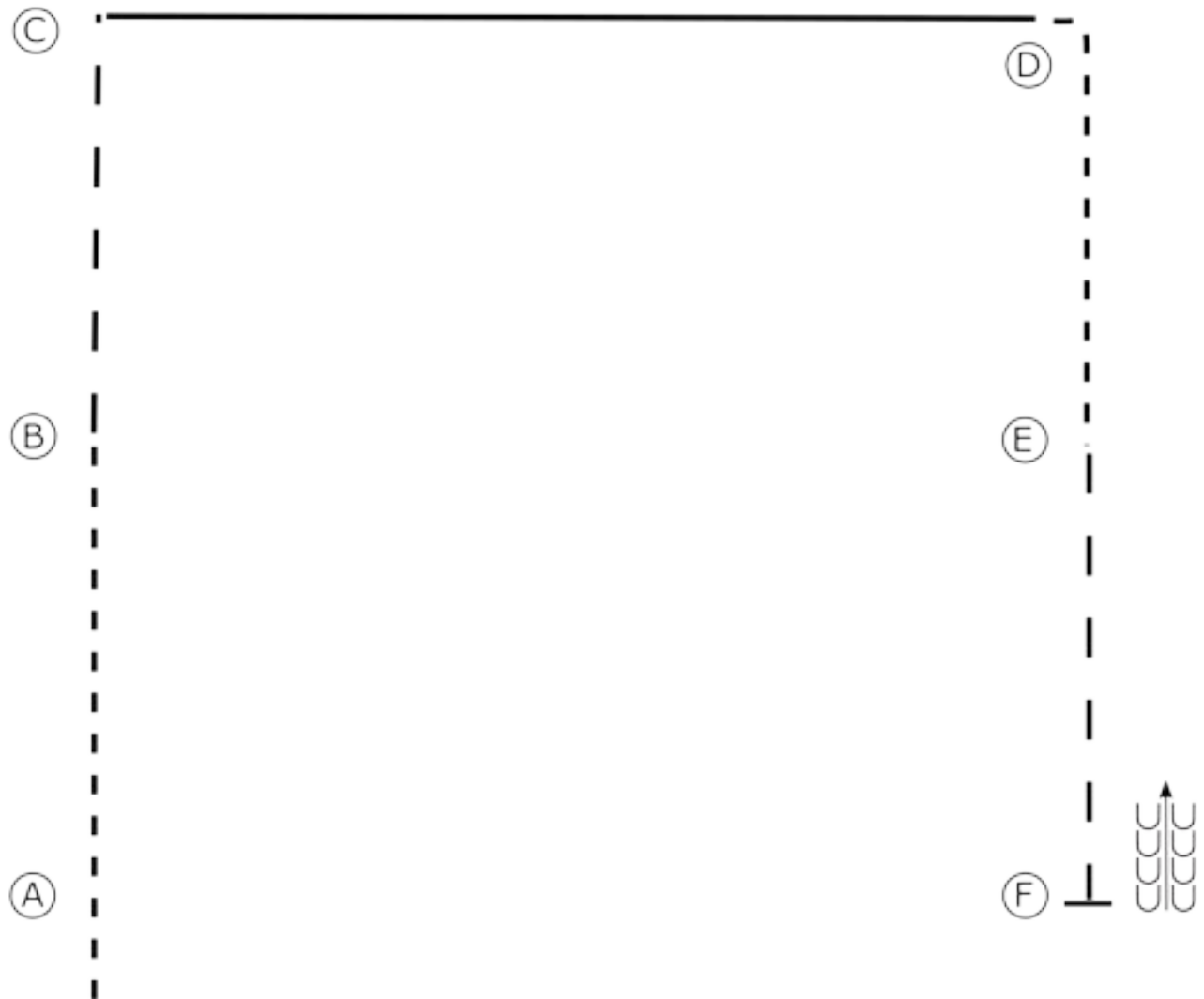

1. Walk to A
2. Walk from A to B
3. At B, jog to C
4. At C, turn right and lope on the right lead to D
5. At D walk to E
6. At E jog to F
7. Stop at F and back approximately one horse length.

Walk ······

Jog - - -

Extended Jog — — —

Lope —————

Back ← 

Marker (A)

Ruby Pattern 4

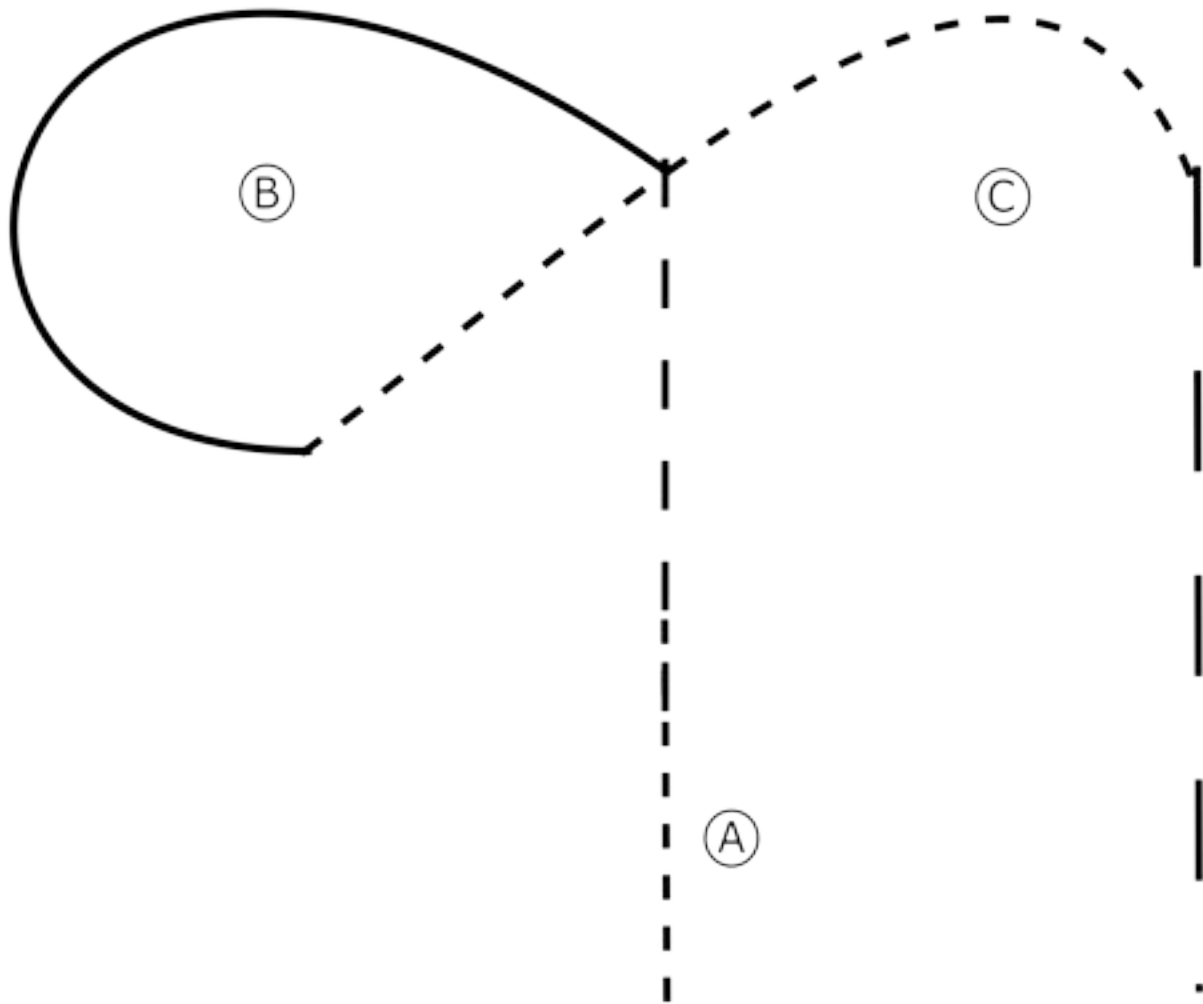

1. Walk to A
2. Jog until between B and C
3. Lope on the left lead around B and toward C
4. Jog to and around C
5. When even with C, extend the jog to exit
6. Pattern is over once you have passed A.

Walk ······

Jog - - -

Extended Jog — —

Lope —————

Back ←

Marker (A)

Ruby Pattern 5

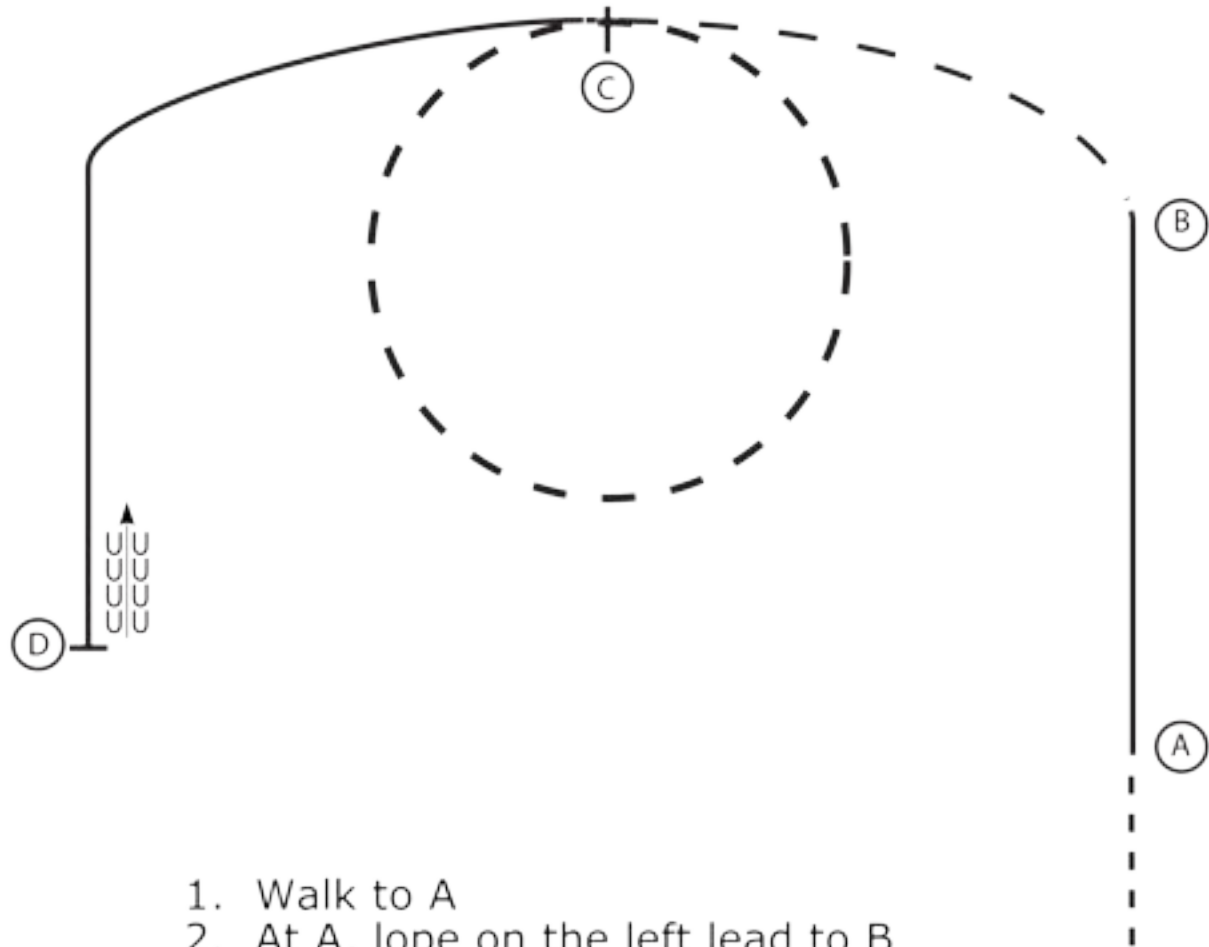

1. Walk to A
2. At A, lope on the left lead to B
3. At B, break to a jog to C
4. At C, jog a circle to the left
5. At completion of circle, lope left lead to D
6. Stop at D, and back 5 steps.

Walk

Jog - - -

Extended Jog — —

Lope —————

Back ← 

Marker (A)

Ruby Pattern 6

1. Walk to A
2. Walk halfway to B
3. Jog to and around B
4. Lope on the left lead diagonally back to A
5. Break to a walk around A
6. Stop and back approximately 2 horse lengths
7. Walk straight away

Walk ······

Jog - - - -

Extended Jog — — — —

Lope —————

Back ← 

Marker (A)

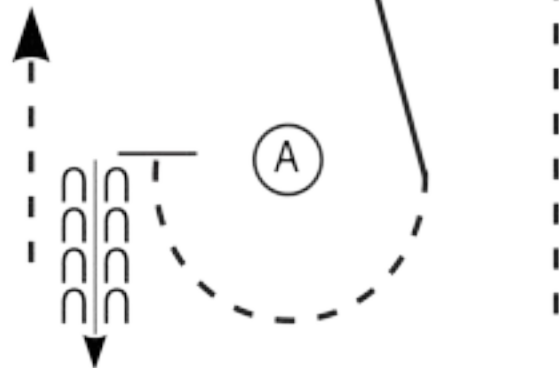

Ruby Pattern 7

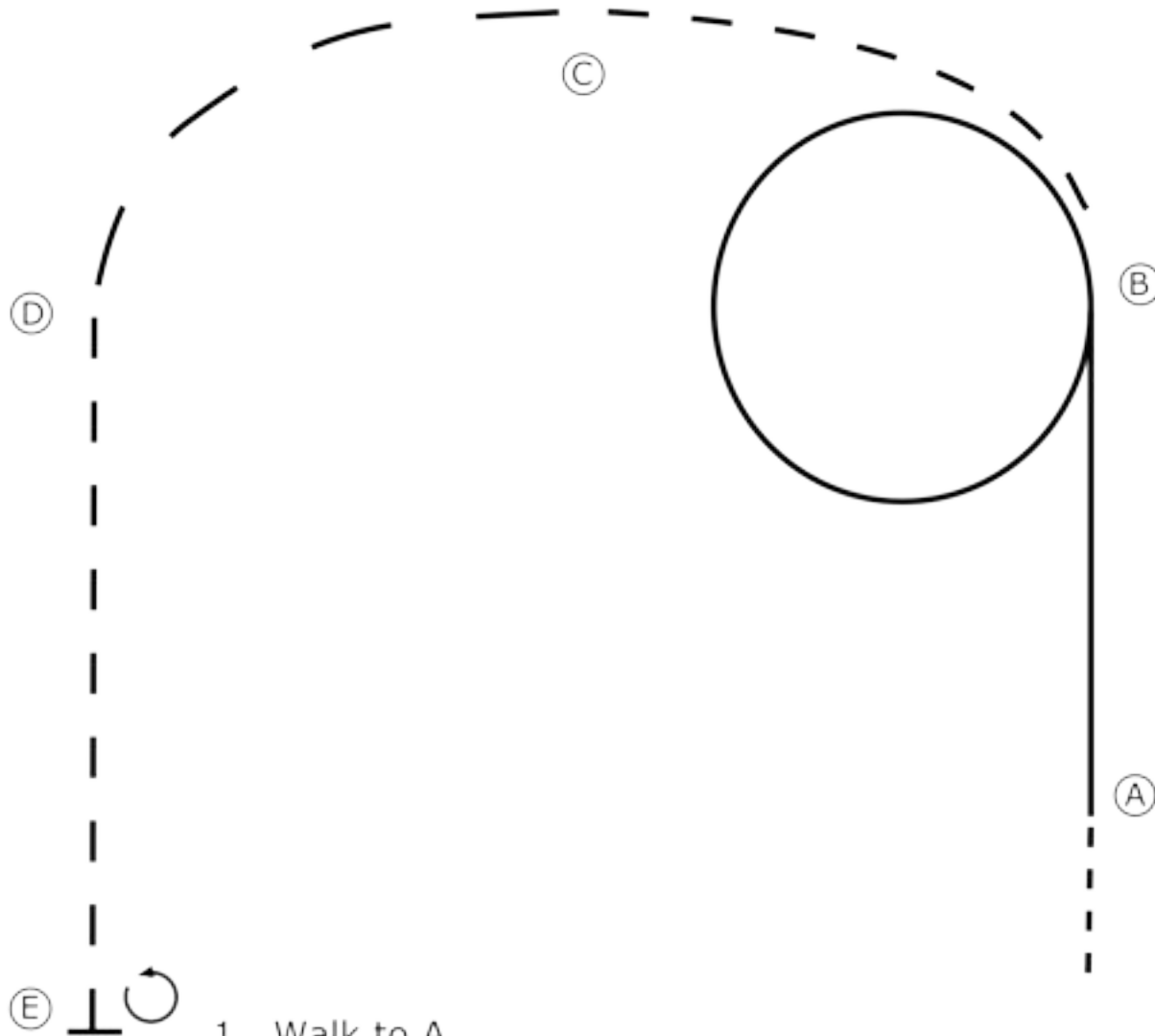

1. Walk to A
2. Lope on left lead from A to B
3. At B, lope a circle to the left
4. After completion of circle, break to a jog to C
5. At C, extend the jog to D
6. At D, return to regular jog to E
7. At E, stop, perform a 360 degree turn to the left.

Walk ······

Jog - - -

Extended Jog — — —

Lope —————

Back ← 

Marker (A)

Ruby Pattern 8

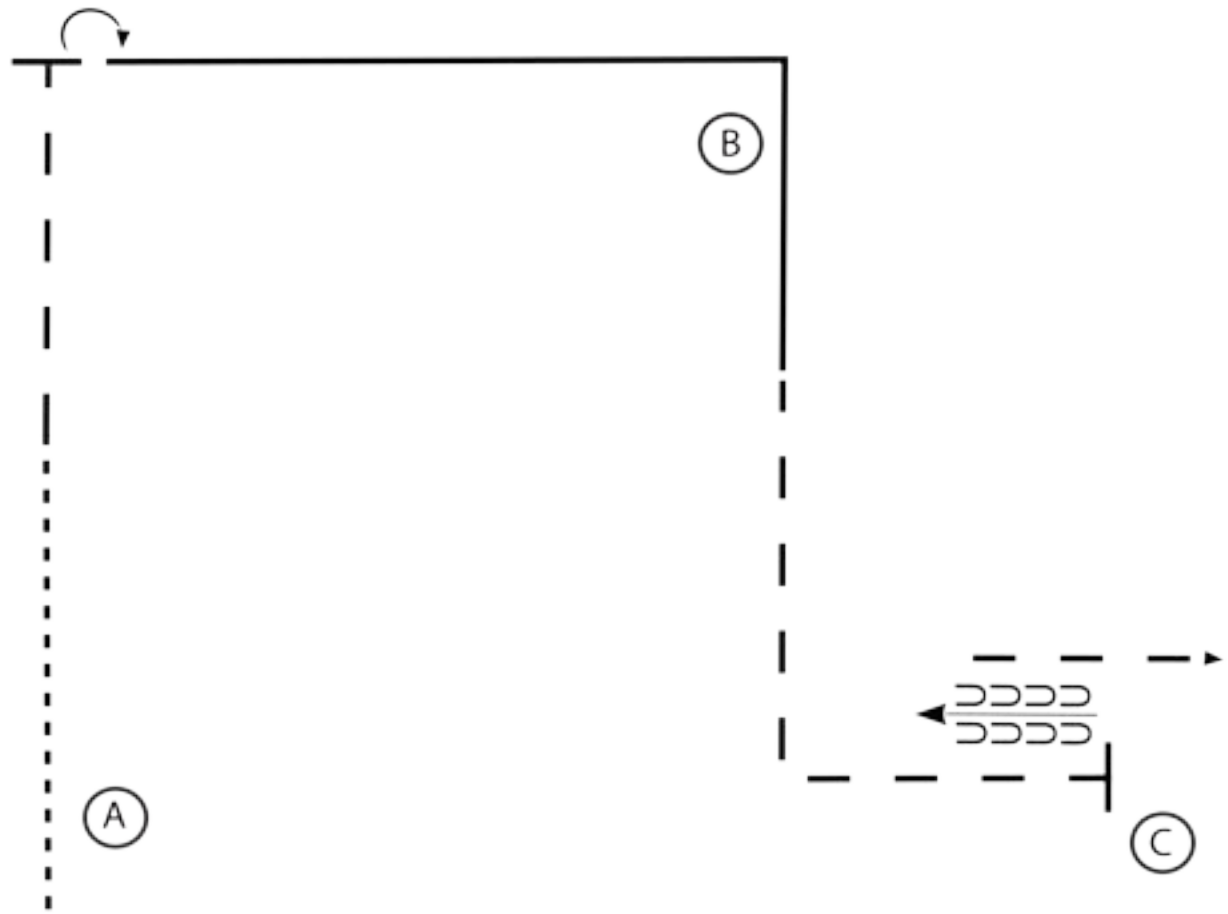

1. Walk to A
2. Walk from A to center of the pattern
3. Jog until just past B and stop
4. Perform a 1/4 turn to the right
5. Lope on the right lead to and around B
6. Break to the jog in the center of the pattern
7. Jog until even with A and C
8. Perform a square corner and jog to C
9. Stop at C and back approximately one horse length
10. Jog off straight past C
11. Pattern is over once you pass C at the jog.

Walk ······

Jog — — —

Extended Jog — — —

Lope —————

Back ← 

Marker (A)

Ruby Pattern 9

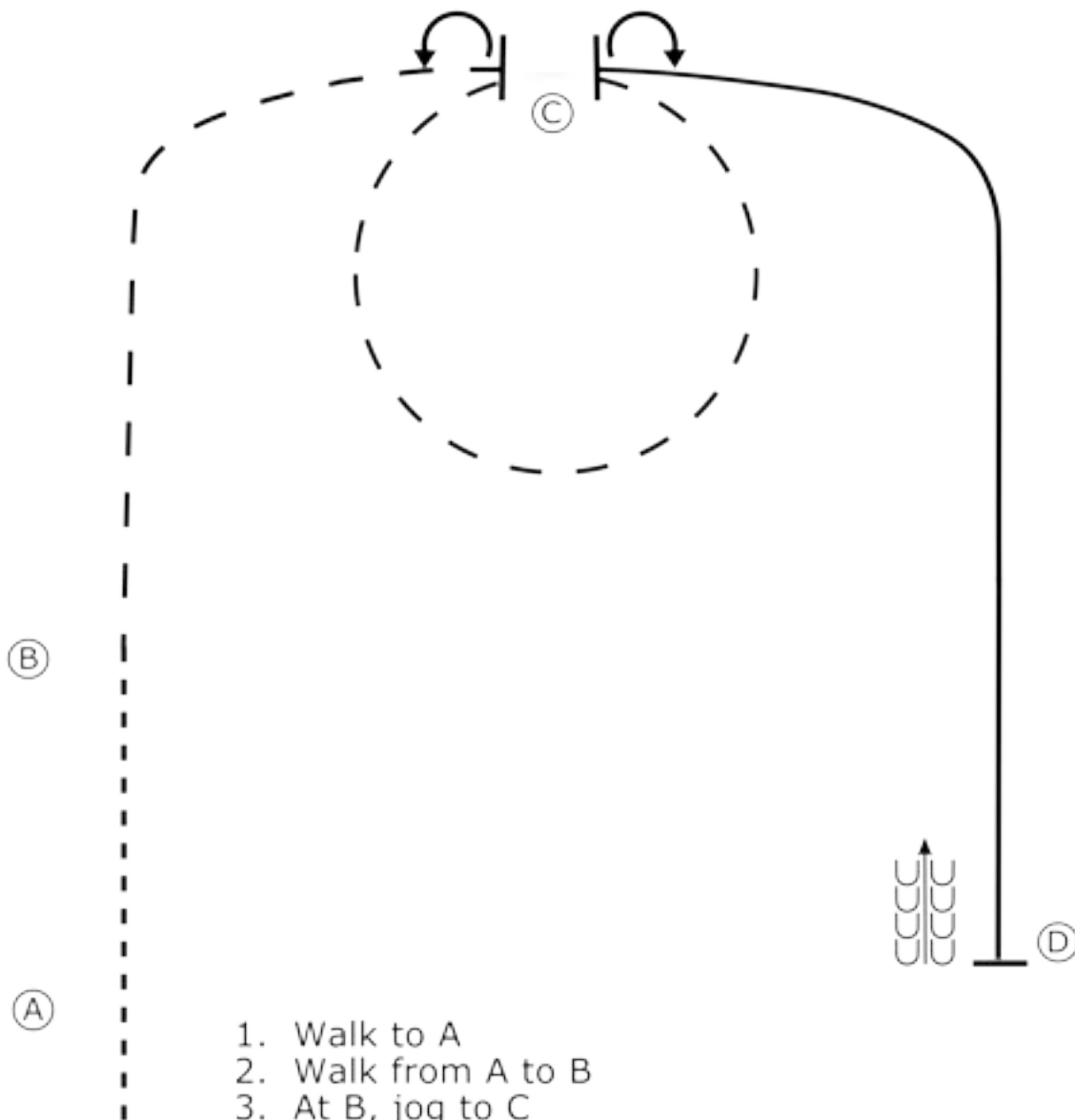

1. Walk to A
2. Walk from A to B
3. At B, jog to C
4. Stop and turn 180 degrees to the left
5. Jog a circle around C
6. Stop at C and turn 180 degrees to the right
7. Lope on the right lead to D
8. Stop at D and back one horse length.

Walk ······

Jog - - -

Extended Jog — —

Lope —————

Back ←

Marker (A)

Ruby Pattern 10

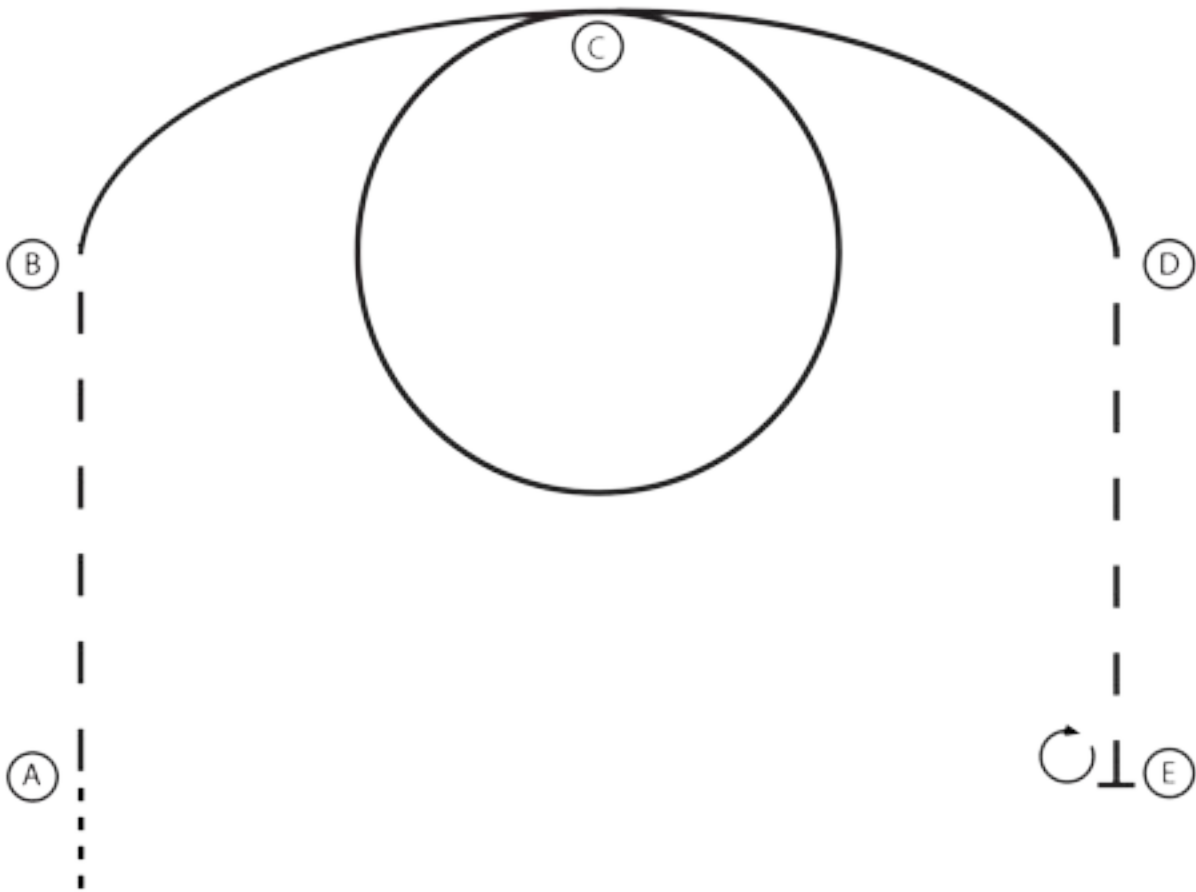

1. Walk to A
2. At A, jog to B
3. At B, lope on the right lead to C
4. At C, execute a circle on the right lead around C to D
5. Regular jog from D to E
6. At E stop and perform a 360 degree turn to the right.

Walk ······

Jog - - -

Extended Jog — —

Lope —————

Back ← 

Marker (A)

Ruby Pattern 11

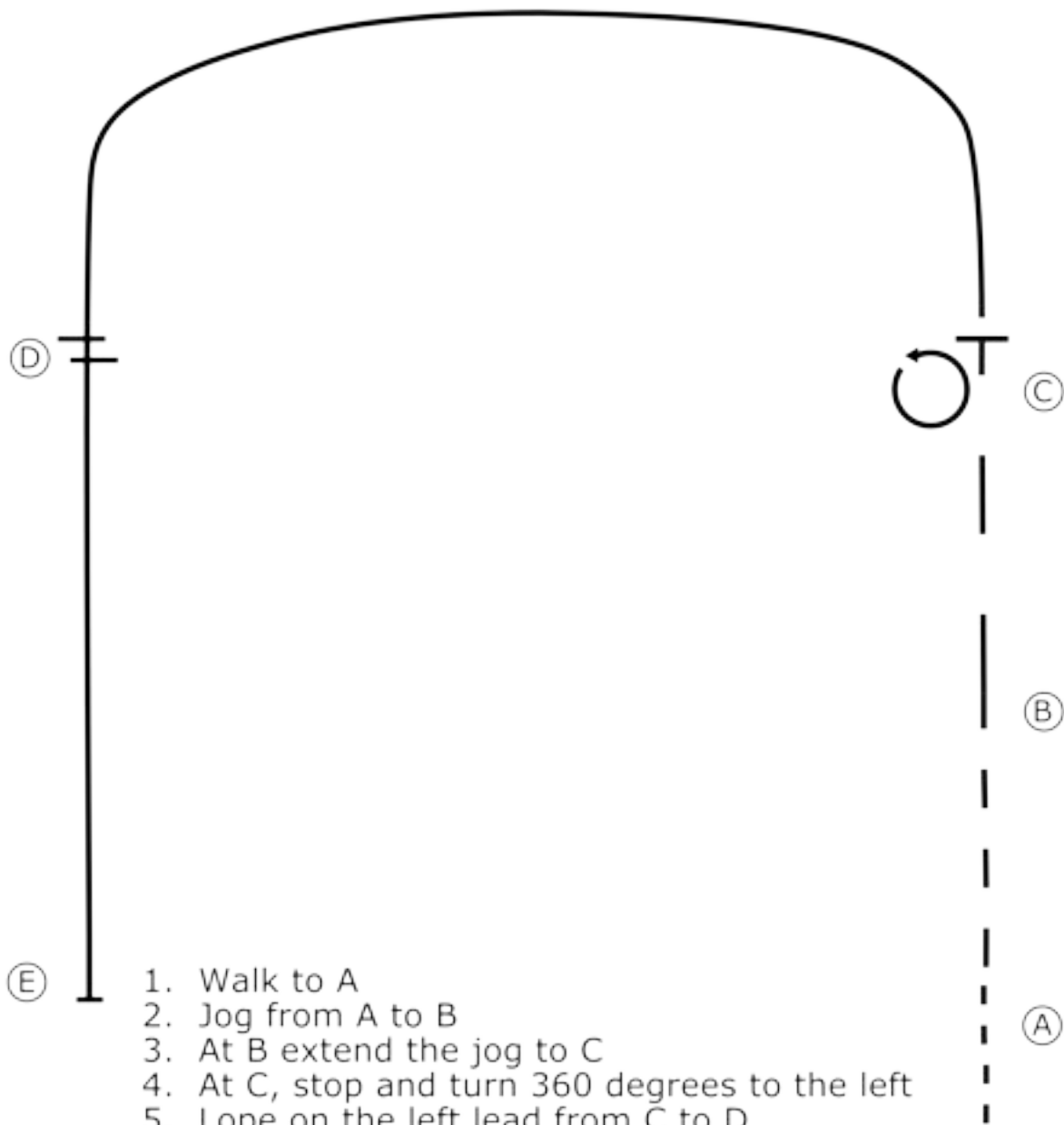

1. Walk to A
2. Jog from A to B
3. At B extend the jog to C
4. At C, stop and turn 360 degrees to the left
5. Lope on the left lead from C to D
6. At D, simple lead change and continue to E
7. Stop at E.

Walk

Jog - - -

Extended Jog — —

Lope —————

Back ←

Marker (A)

Ruby Pattern 13

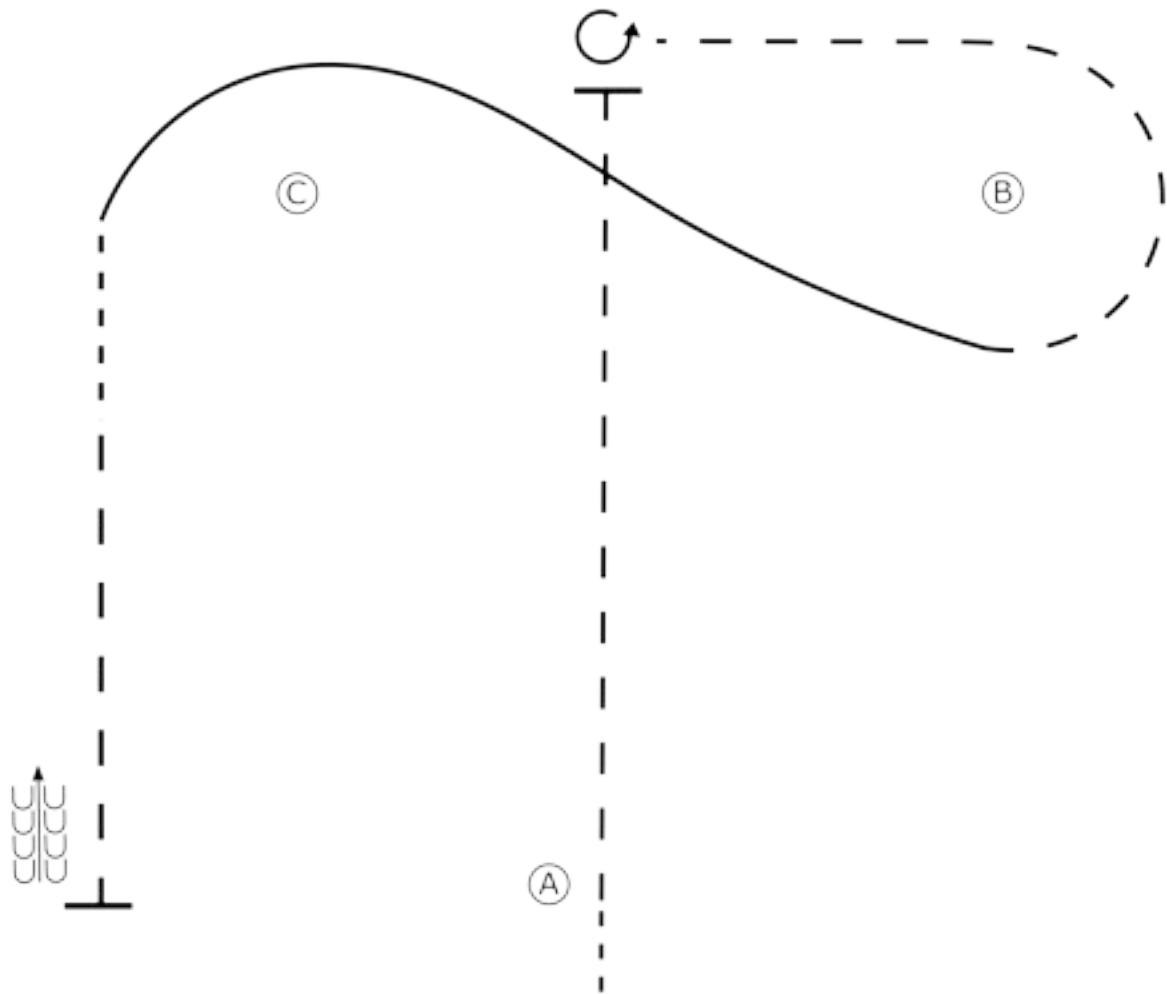

1. Walk to A
2. Jog until just past B and C
3. Stop and perform a 3/4 turn to the left
4. Jog to and around B
5. Lope on the left lead to and around C
6. Break to a walk for 2 strides
7. Jog until even with A
8. Stop and back approximately one horse length and walk to exit

Walk
 Jog - - -
 Extended Jog — —
 Lope _____
 Back ← 
 Marker (A)

Ruby Pattern 14

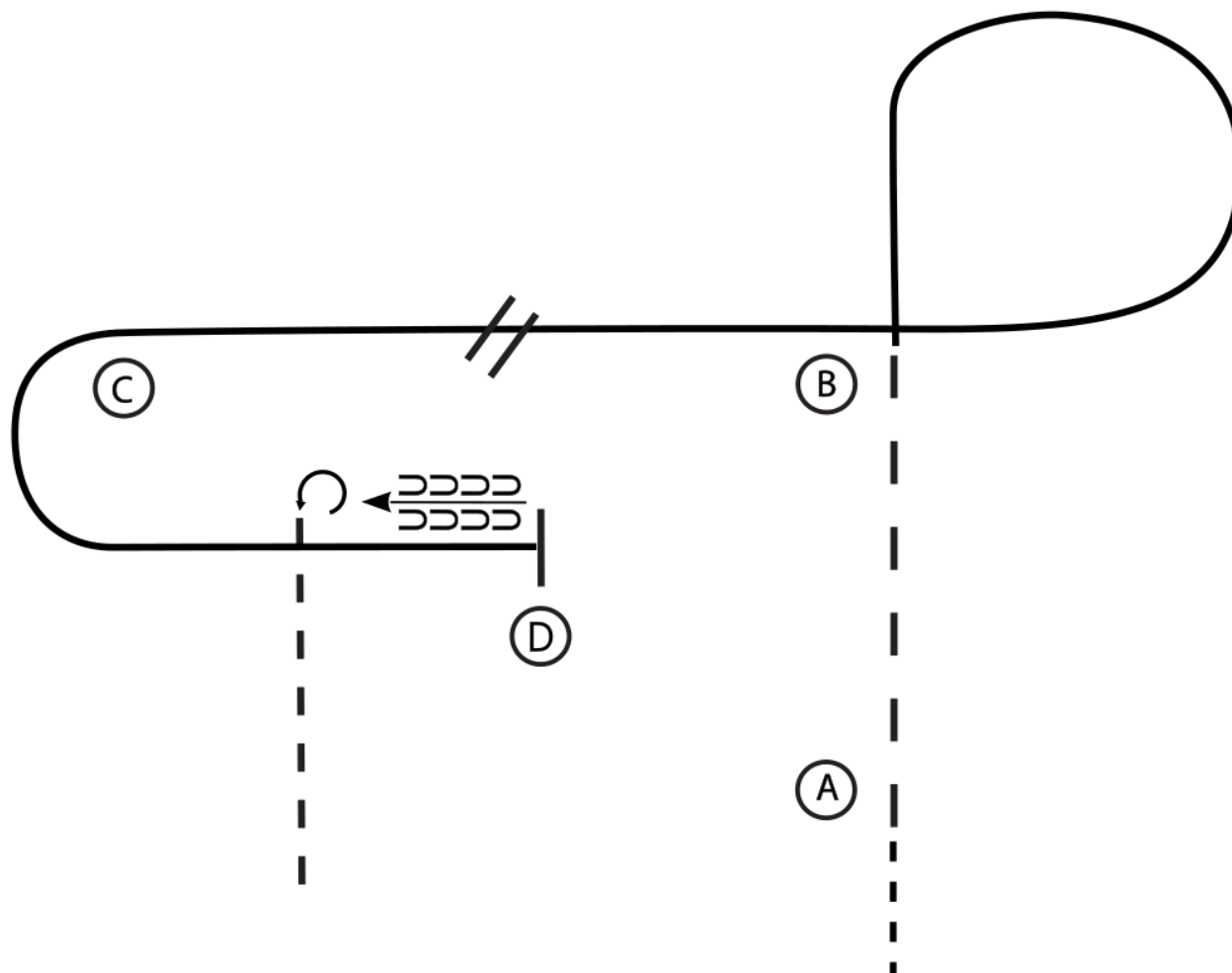

1. Walk to A
2. Jog from A to B
3. At B, lope a circle to the right on the right lead
4. Halfway between B and C, perform a simple lead change
5. Lope on the left lead to D
6. Stop at D and back approximately one horse length
7. Perform a 3/4 turn to the left and walk off.

Walk ······

Jog - - -

Extended Jog — — —

Lope —————

Back ←

Marker (A)

Ruby Pattern 15

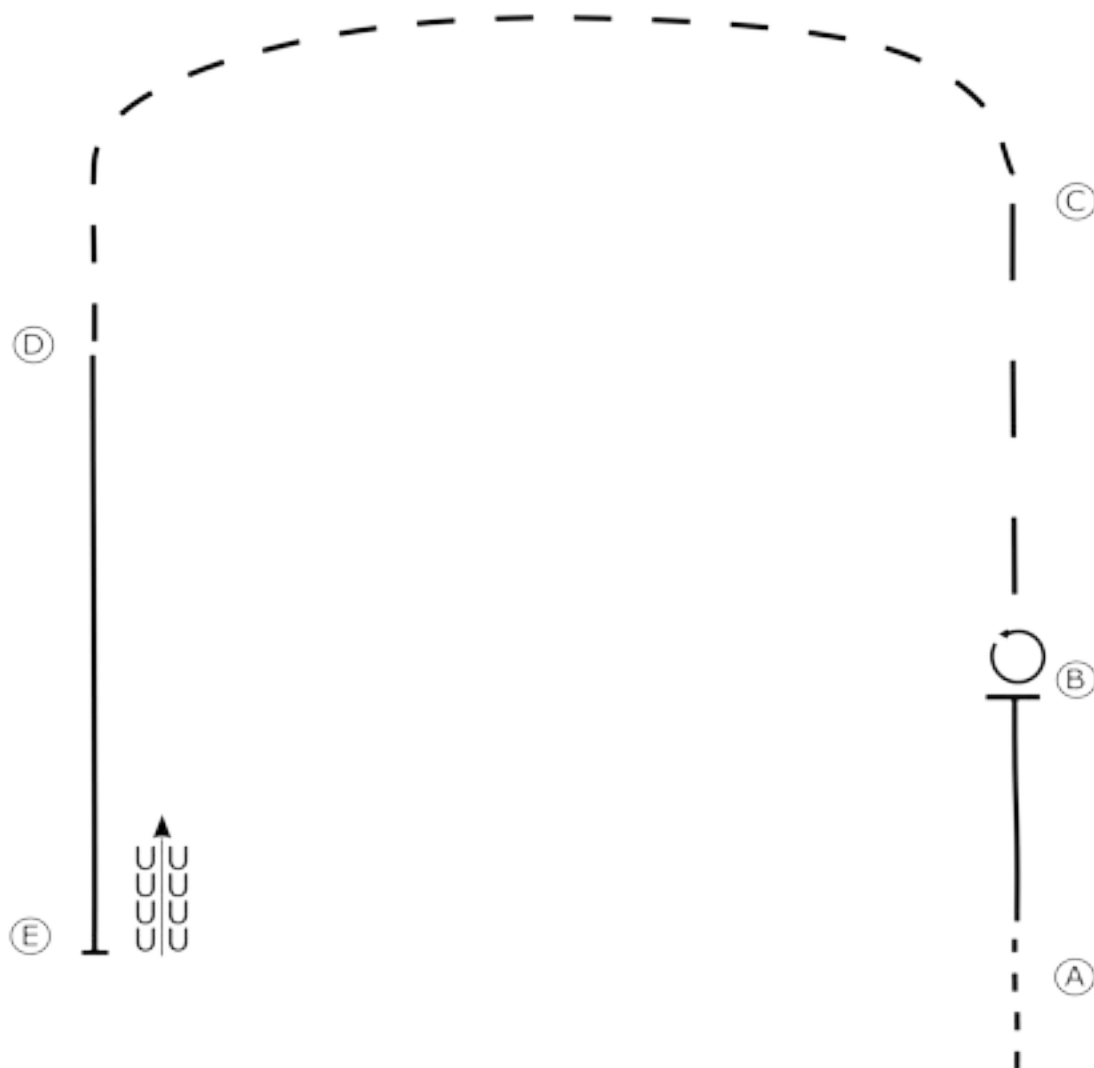

1. Walk to A
2. Lope on the left lead from A to B
3. At B, stop and perform a 360 to the left on the hindquarters
4. Extend the jog to C
5. Normal jog from C to D
6. Lope on the right lead from D to E
7. At E, stop and back.

Walk ······

Jog - - -

Extended Jog — —

Lope —————

Back ←

Marker (A)

Ruby Pattern 16

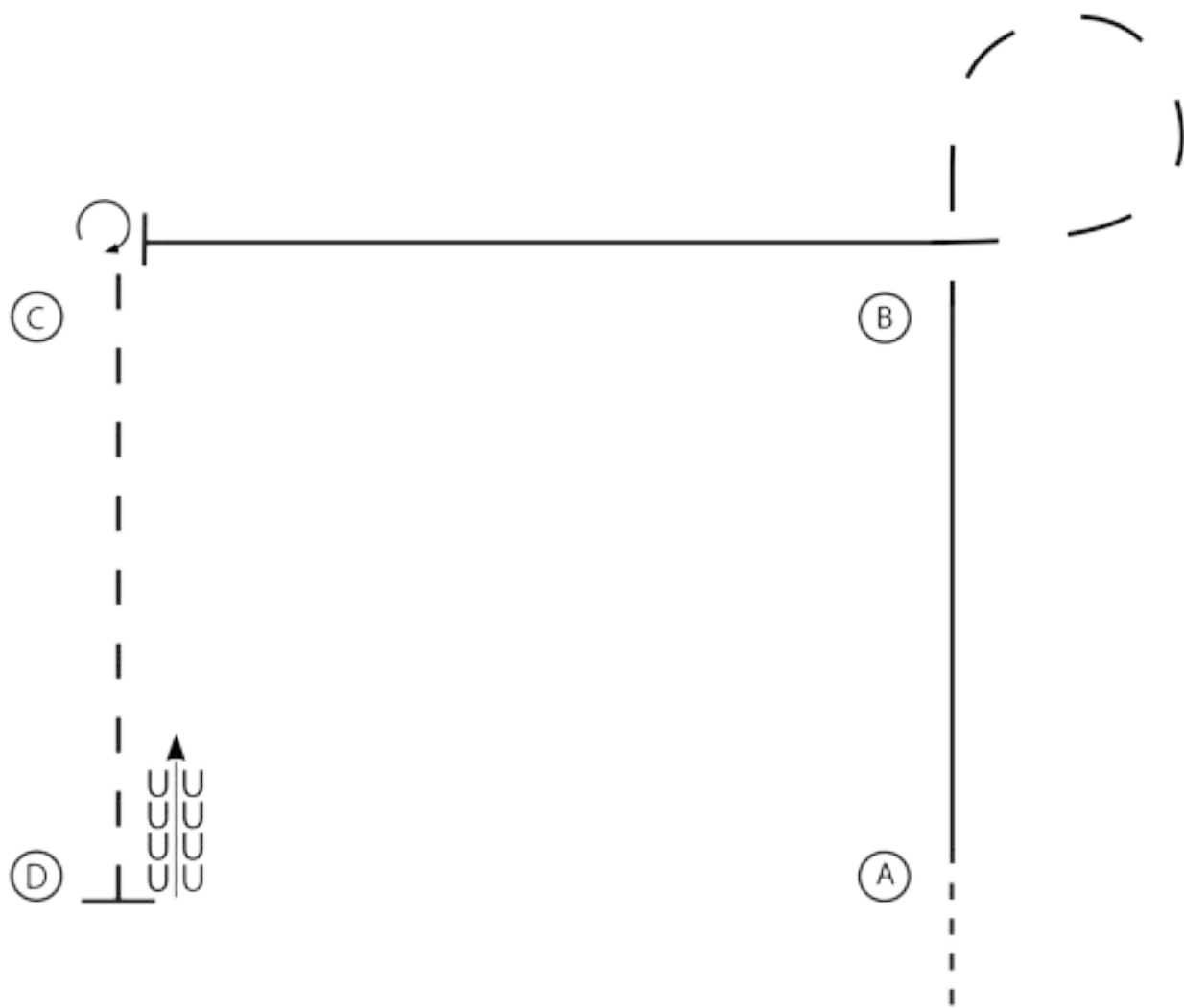

1. Walk to A
2. Lope on the right lead to B
3. At B, extend the jog in a circle to the right
4. At B, lope on the left lead to C
5. At C, stop and perform a 270 degree turn to the right
6. Jog to D
7. At D, stop and back 4 steps.

Walk ······

Jog - - -

Extended Jog — —

Lope _____

Back ← 

Marker (A)

Ruby Pattern A

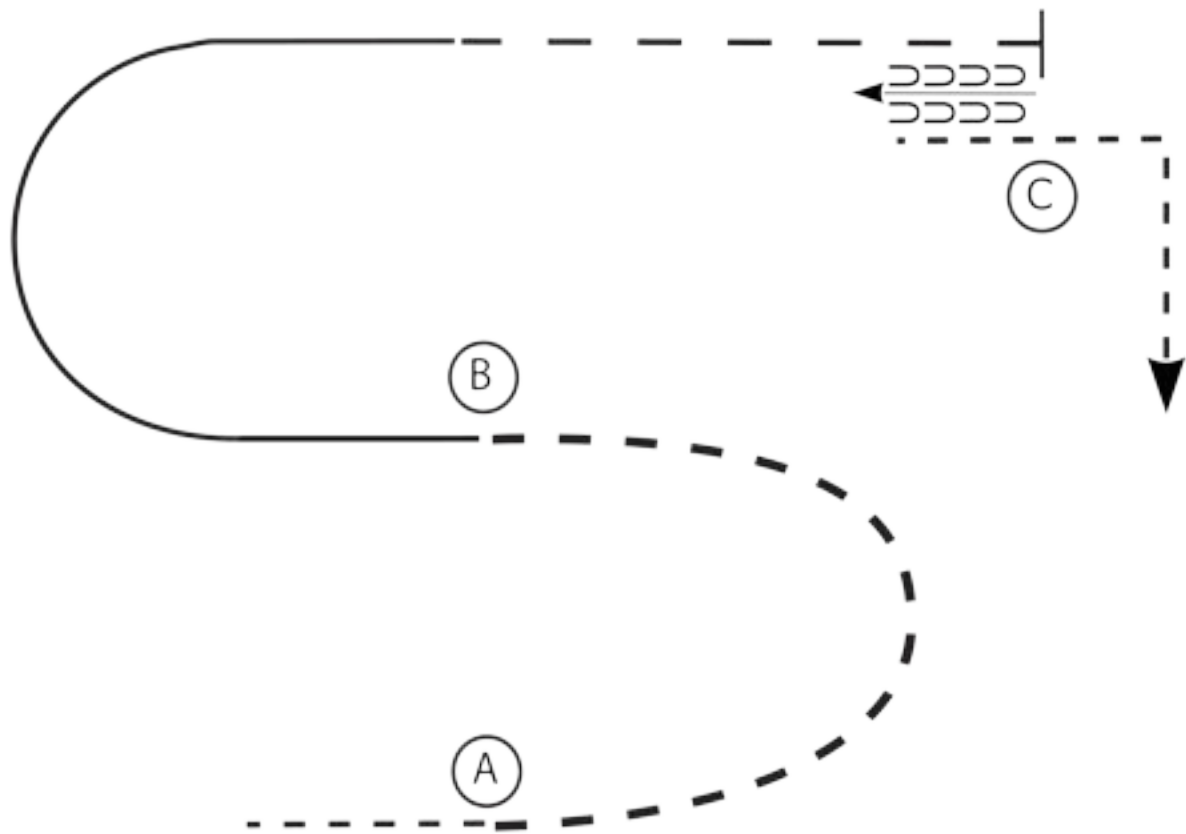

1. Walk to A
2. Jog half circle to B
3. At B, lope on the right lead in a half circle until even with B
4. Break to the jog to C
5. Stop and back at C
6. Jog to exit as shown.

Walk ······

Jog - - -

Extended Jog — —

Lope —————

Back ← 

Marker (A)

Ruby Pattern B

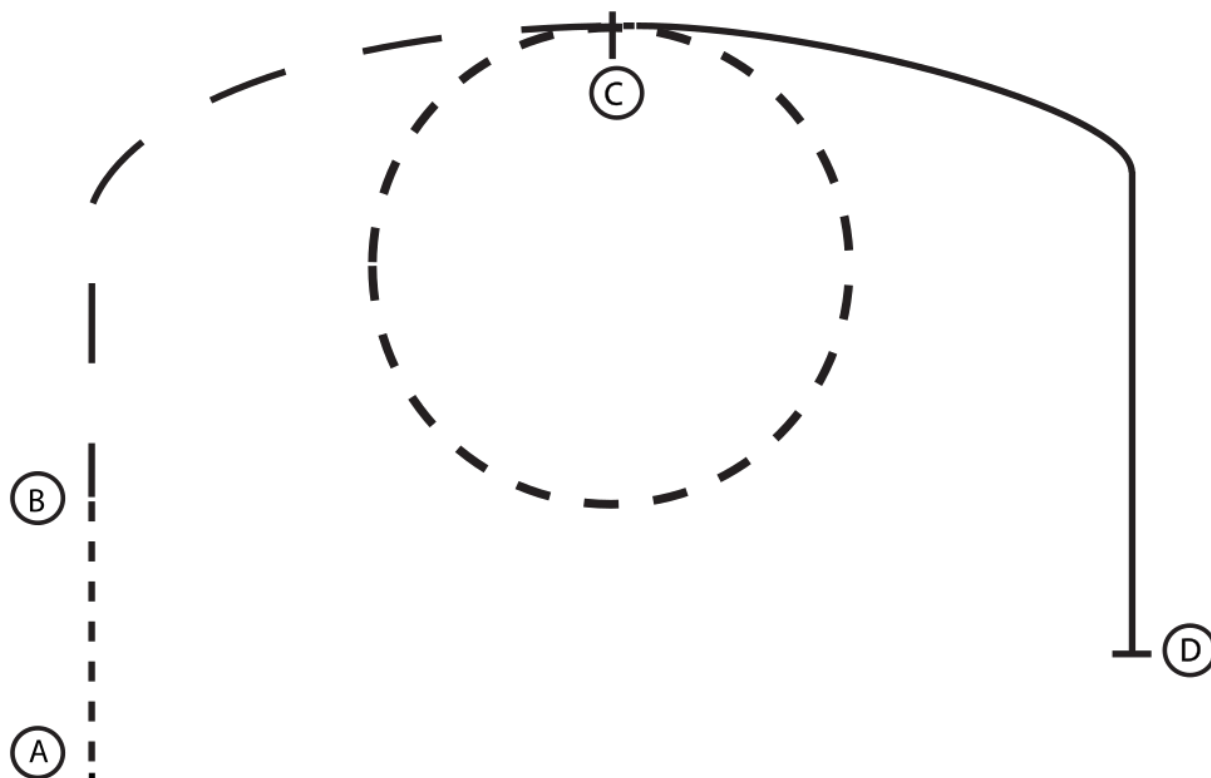

1. Walk to A
2. At A, walk to B
3. At B, extend the jog to C
4. At C, jog a circle to the right
5. At completion of circle, lope right lead to D
6. Stop at D.

Walk ······

Jog - - -

Extended Jog — —

Lope —————

Back ←

Marker (A)

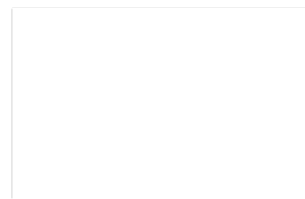

Sapphire/Alumni Pattern 1

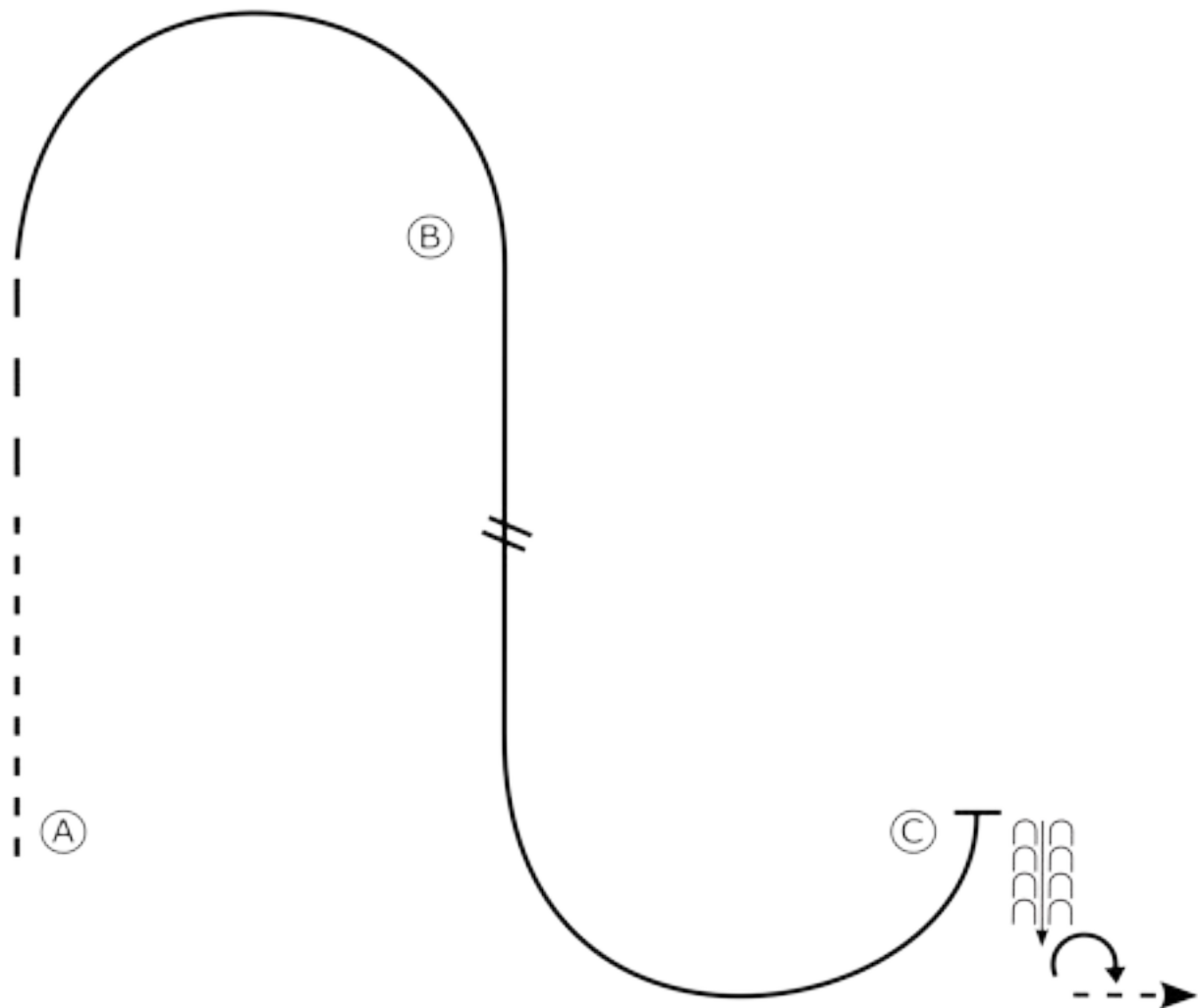

1. Walk from A to center of pattern
2. Jog until even with B
3. Lope a half circle on the right lead to and around B
4. Perform a simple lead change in the center of the pattern
5. Lope a half circle on the left lead to C
6. Stop at C and back approximately one horse length
7. Perform a 1/4 turn to the right and walk off.

Walk ······

Jog - - -

Extended Jog — —

Lope —————

Back ←

Marker (A)

Sapphire/Alumni Pattern 2

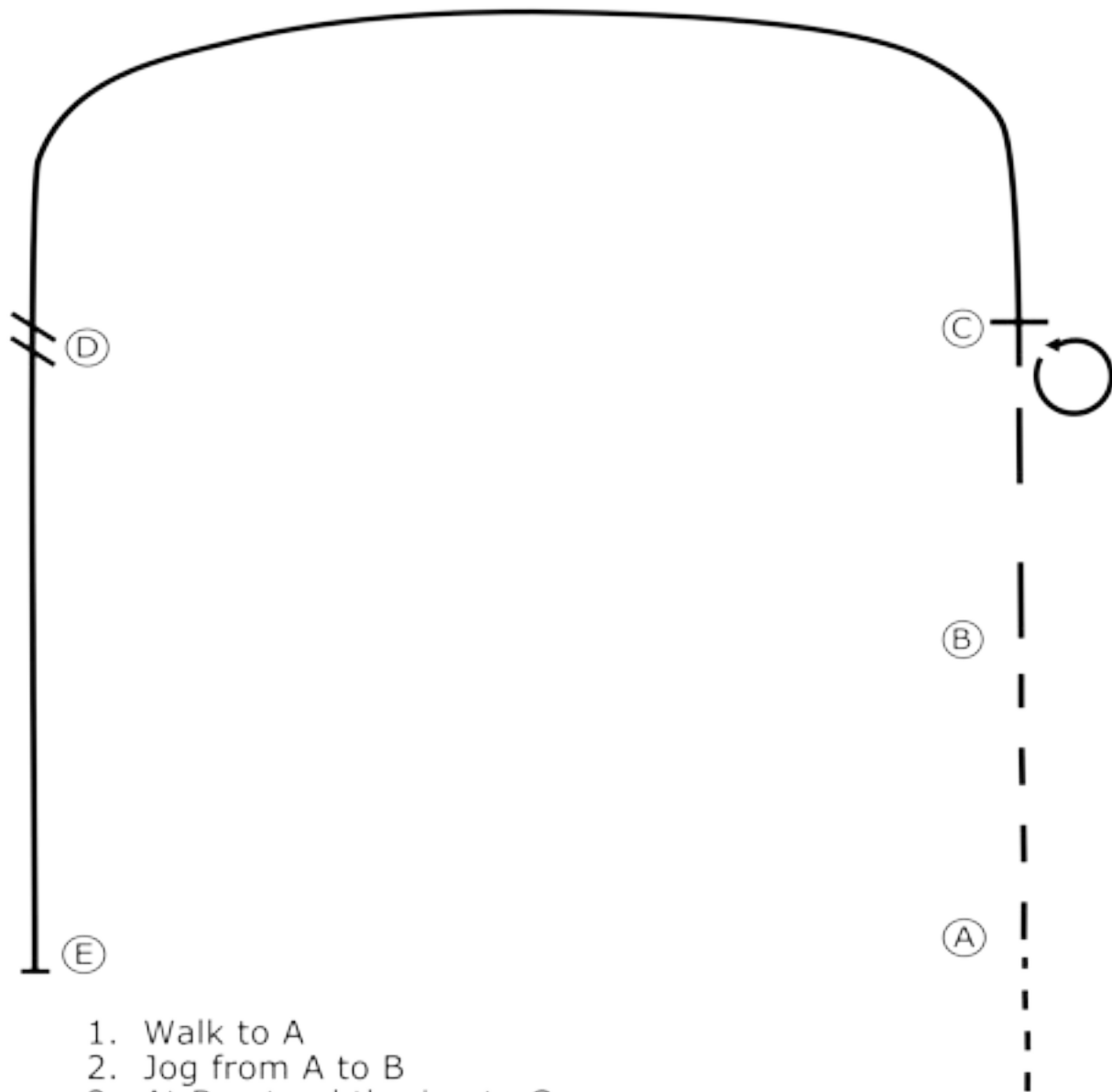

1. Walk to A
2. Jog from A to B
3. At B extend the jog to C
4. At C, stop and perform a 360 degree turn to the left
5. Lope on the left lead in a half circle from C to D
6. At D, simple lead change and continue to E
7. Stop at E.

Walk ······

Jog — — —

Extended Jog — — —

Lope —————

Back ← 

Marker (A)

Sapphire/Alumni Pattern 3

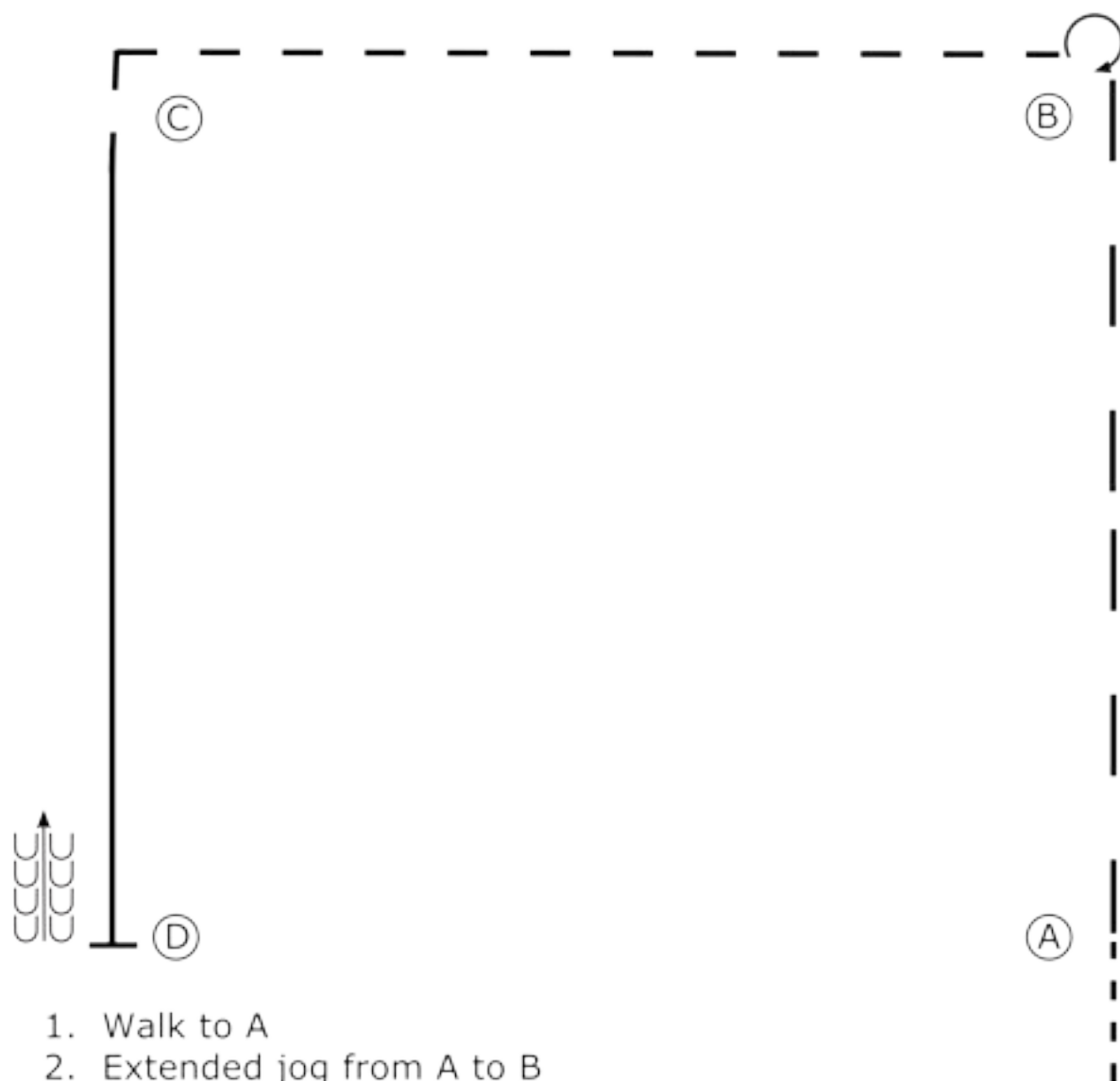

1. Walk to A
2. Extended jog from A to B
3. Stop past B and execute a 270 degree turn to the right
4. Jog from B around C
5. Lope on the left lead from C to D
6. Stop at D and back one horse length.

Walk ······

Jog - - -

Extended Jog — —

Lope —————

Back ← 

Marker (A)

Sapphire/Alumni Pattern 4

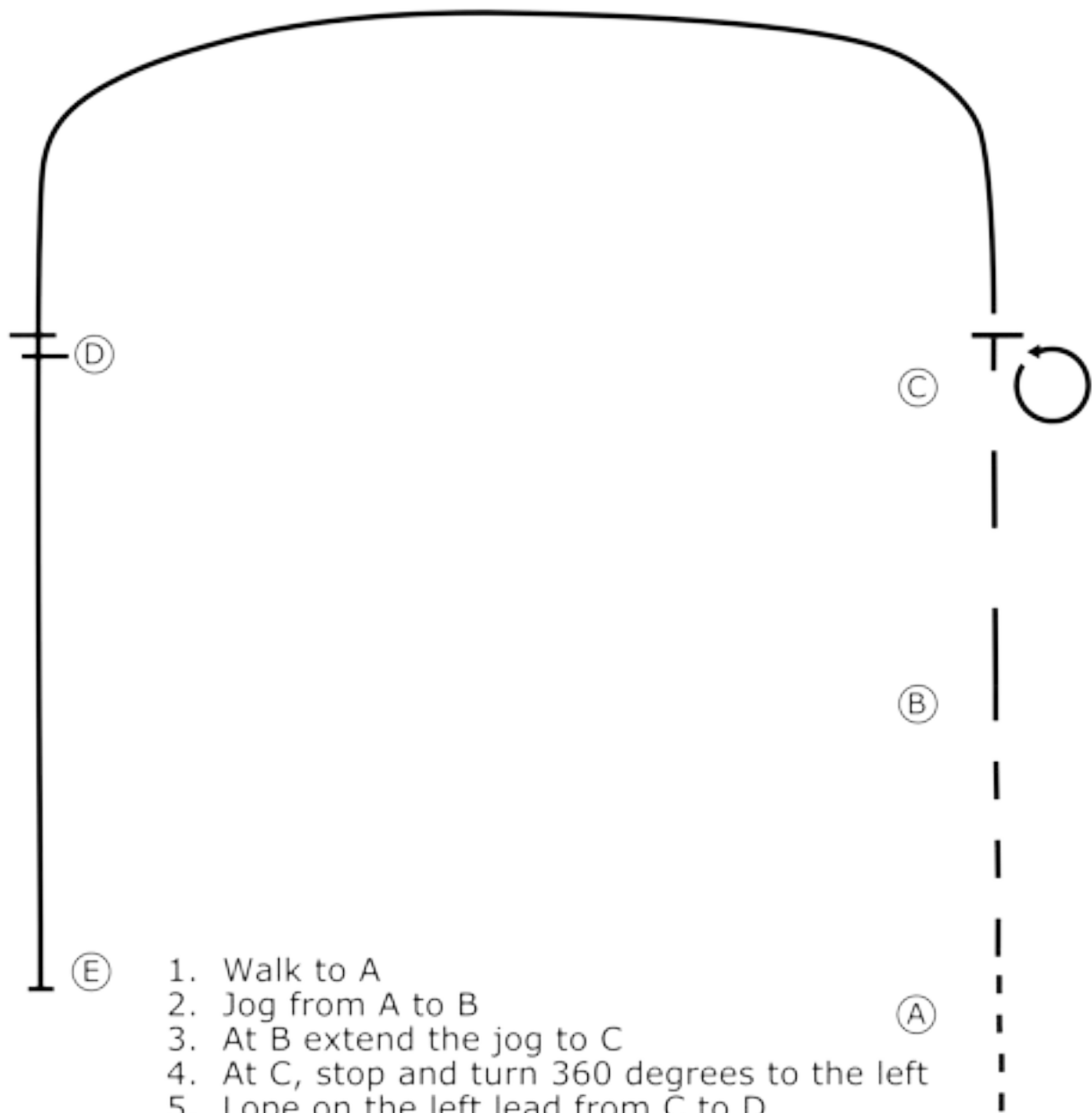

1. Walk to A
2. Jog from A to B
3. At B extend the jog to C
4. At C, stop and turn 360 degrees to the left
5. Lope on the left lead from C to D
6. At D, simple lead change and continue to E
7. Stop at E.

Walk ······

Jog - - -

Extended Jog — — —

Lope —————

Back ← 

Marker (A)

Sapphire/Alumni Pattern 5

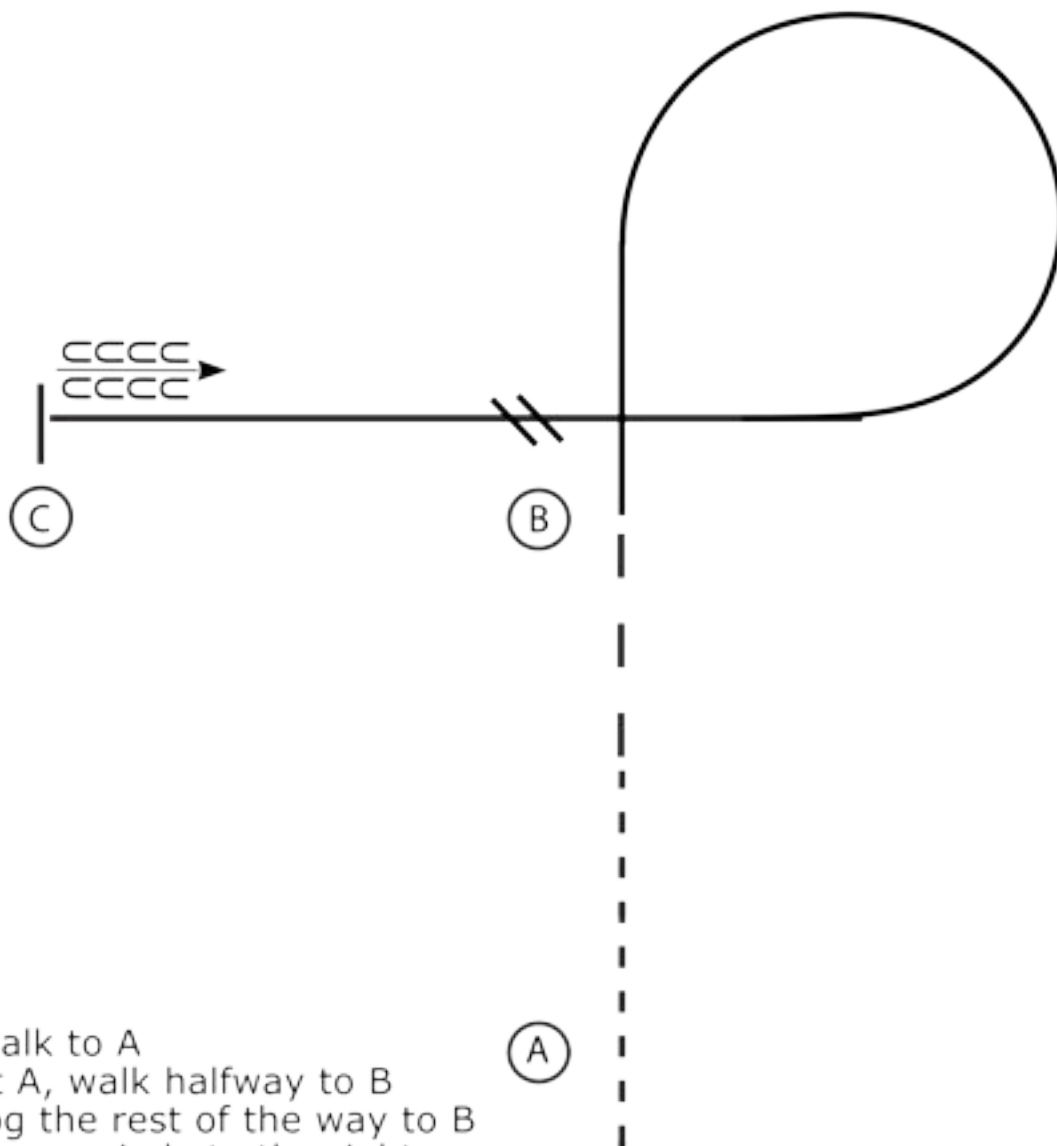

1. Walk to A
2. At A, walk halfway to B
3. Jog the rest of the way to B
4. Lope a circle to the right
5. Change leads at B
6. Lope on the left lead to C
7. Stop at C and back one horse length

Exit at the jog

Walk ······

Jog — — —

Extended Jog — — —

Lope —————

Back ← 

Marker (A)

Sapphire/Alumni Pattern 6

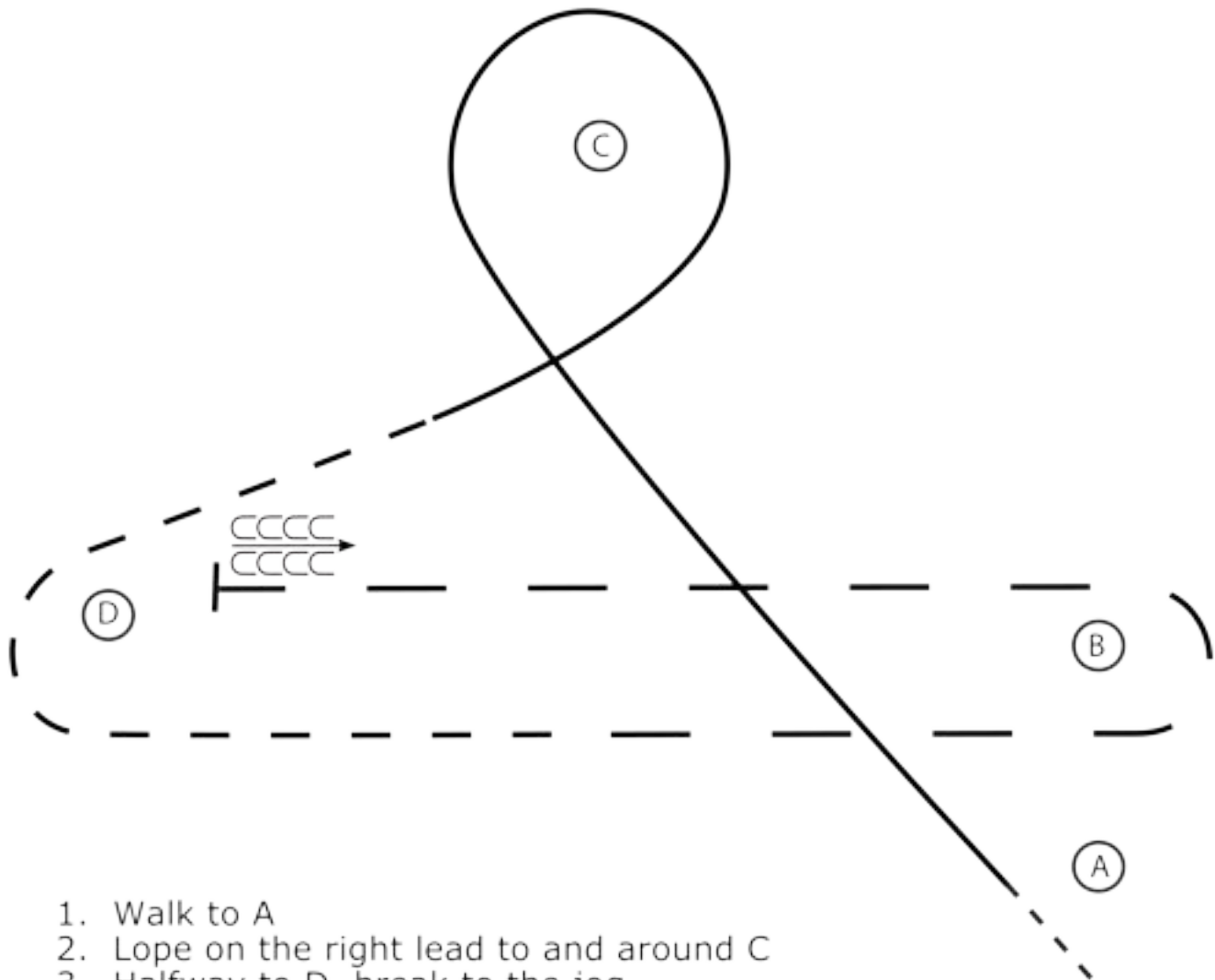

1. Walk to A
2. Lope on the right lead to and around C
3. Halfway to D, break to the jog
4. Jog around D
5. Halfway to B, extend the jog
6. Continue extended jog around B to D
7. At D stop and back approximately one horse length.

Walk ······

Jog - - -

Extended Jog — — —

Lope —————

Back ← 

Marker (A)

Sapphire/Alumni Pattern 7

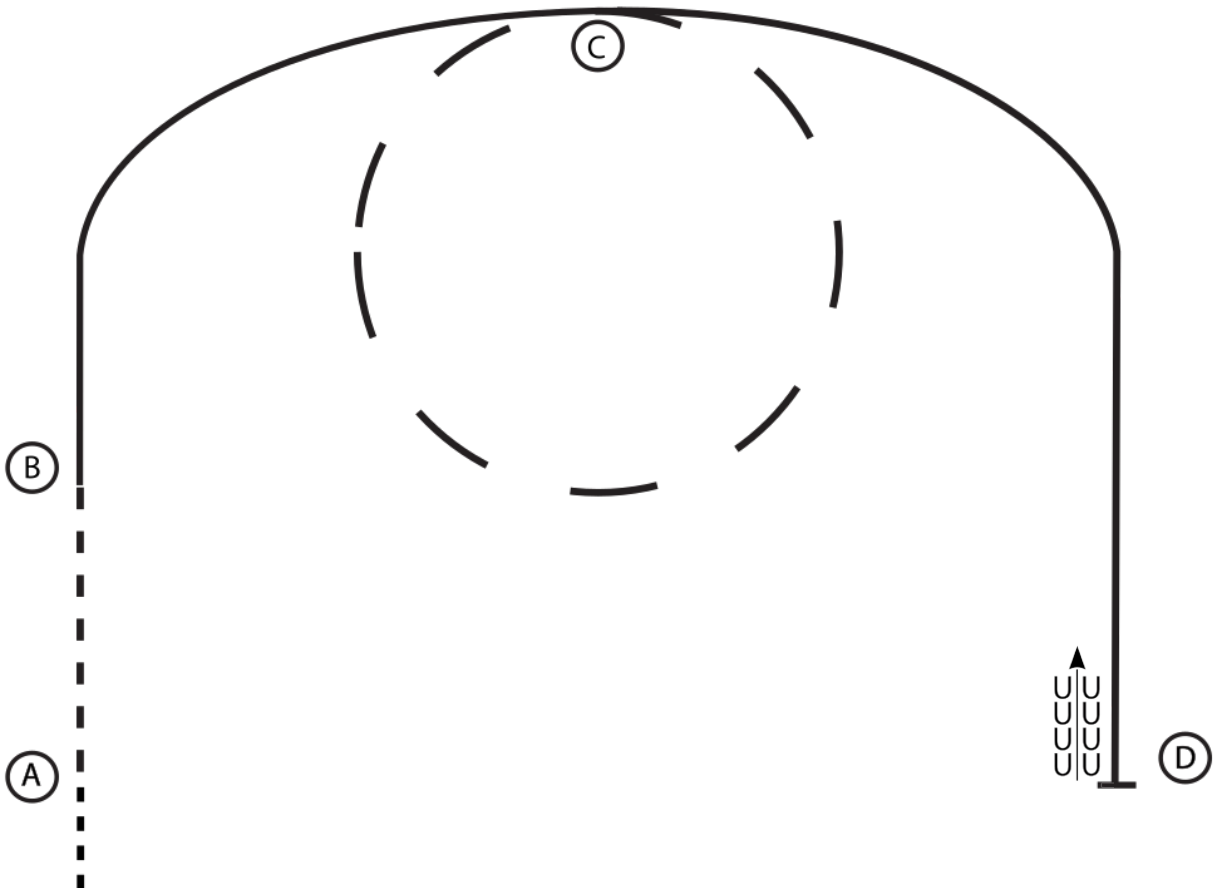

1. Walk to A
2. At A, walk to B
3. At B, lope on the right lead to C
4. At C, break to the extended trot and trot a circle to the right around C
5. Lope on the left lead from C to D
6. At D stop and back approximately one horse length.

Walk ······

Jog - - -

Extended Jog — —

Lope —————

Back ←

Marker (A)

Sapphire/Alumni Pattern 8

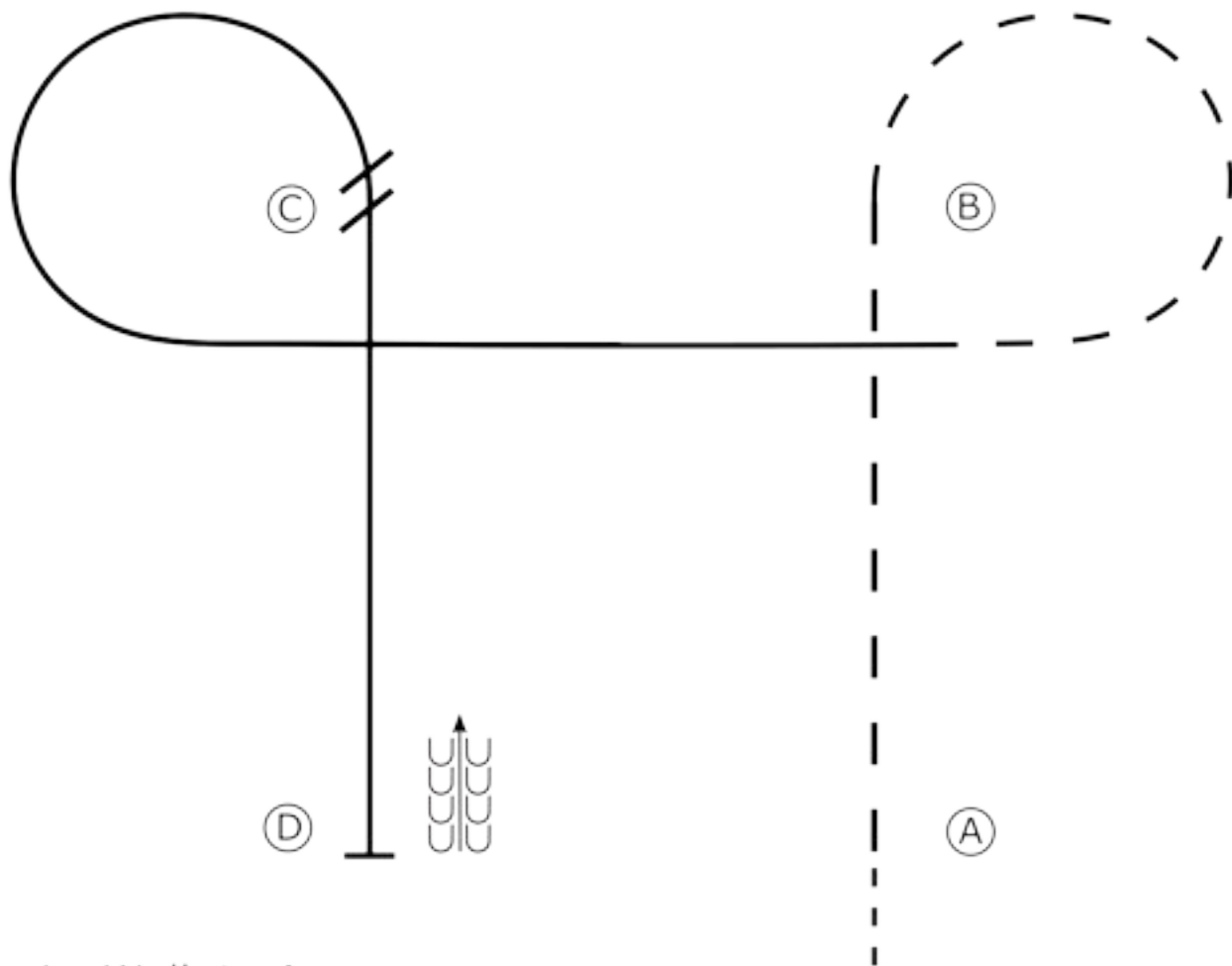

1. Walk to A
2. Jog from A to B
3. Jog a circle around B
4. At B lope on the right lead to C
5. Lope a circle around C
6. At C, perform a simple lead change and continue to D
7. At D, stop and back one horse length.

Walk ······

Jog - - -

Extended Jog — — —

Lope —————

Back ←

Marker (A)

Sapphire/Alumni Pattern 9

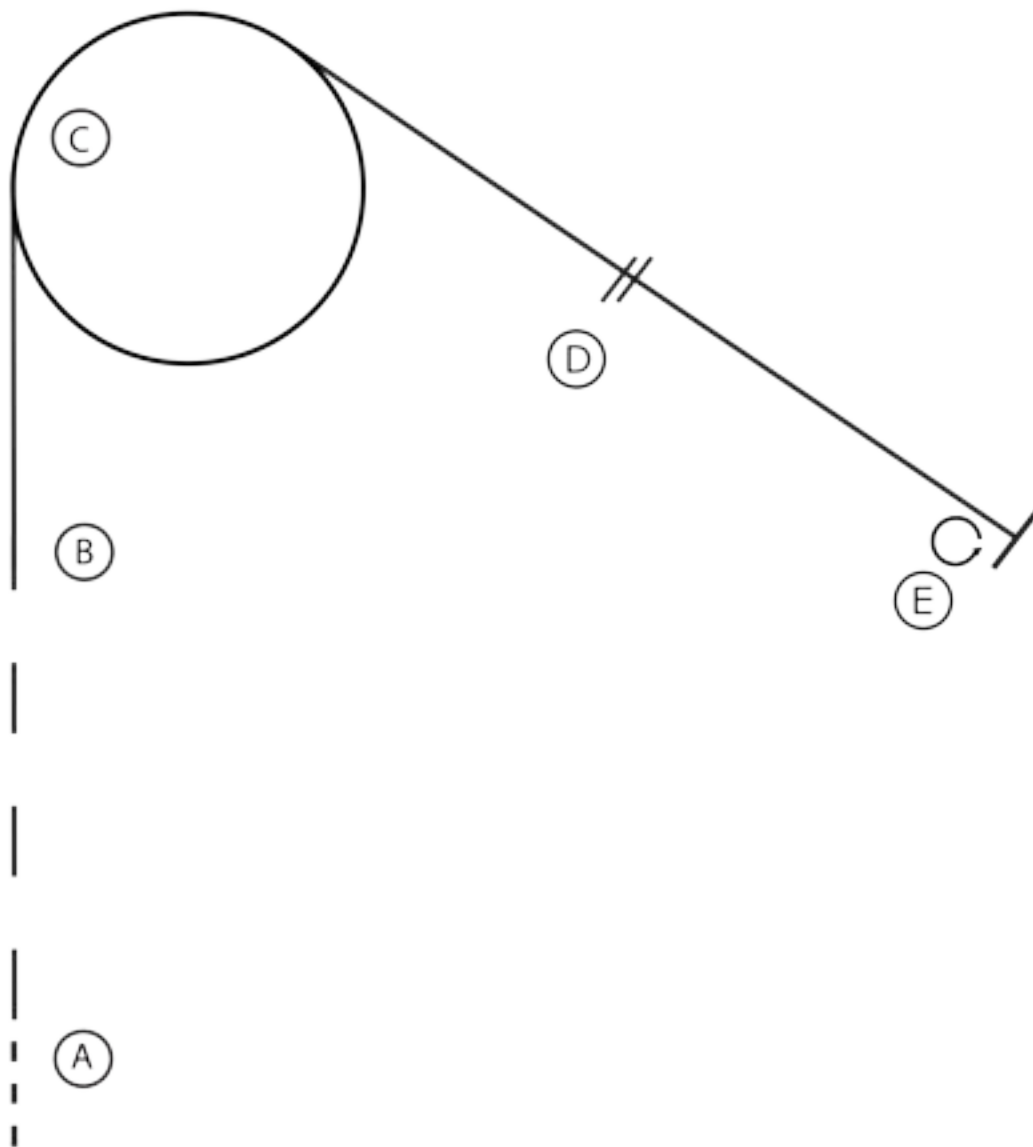

1. Walk to A
2. Extend the jog from A to B
3. At B, Lope on the right lead, to C and perform a circle around C, and continue to D
4. At D, perform a simple lead change and continue to E
5. Stop at E and perform a 360 degree turn to the left.

Walk ······

Jog — — —

Extended Jog — — —

Lope —————

Back ← 

Marker (A)

Sapphire/Alumni Pattern 10

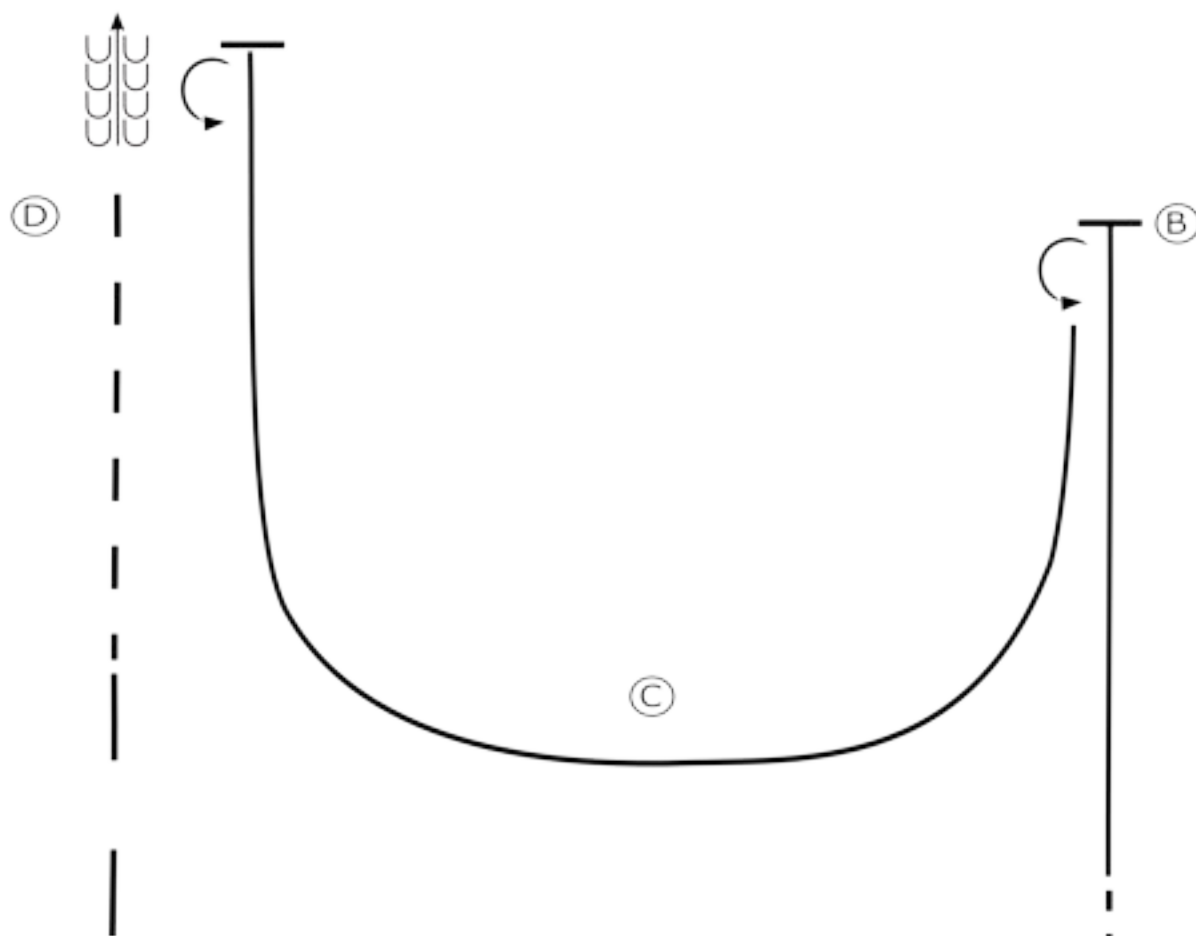

1. Walk to A
2. Walk approximately 2 strides from A
3. Lope on the left lead to B
4. Stop and perform a 180 degree turn to the left
5. Lope on the right lead around C and past D
6. Stop and perform a 180 degree turn to the left
7. Back approximately one horse length
8. Jog halfway to E
9. Extend the jog to E
10. Stop at E.

Walk ······

Jog - - -

Extended Jog — — —

Lope —————

Back ← 

Marker (A)

Sapphire/Alumni Pattern 11

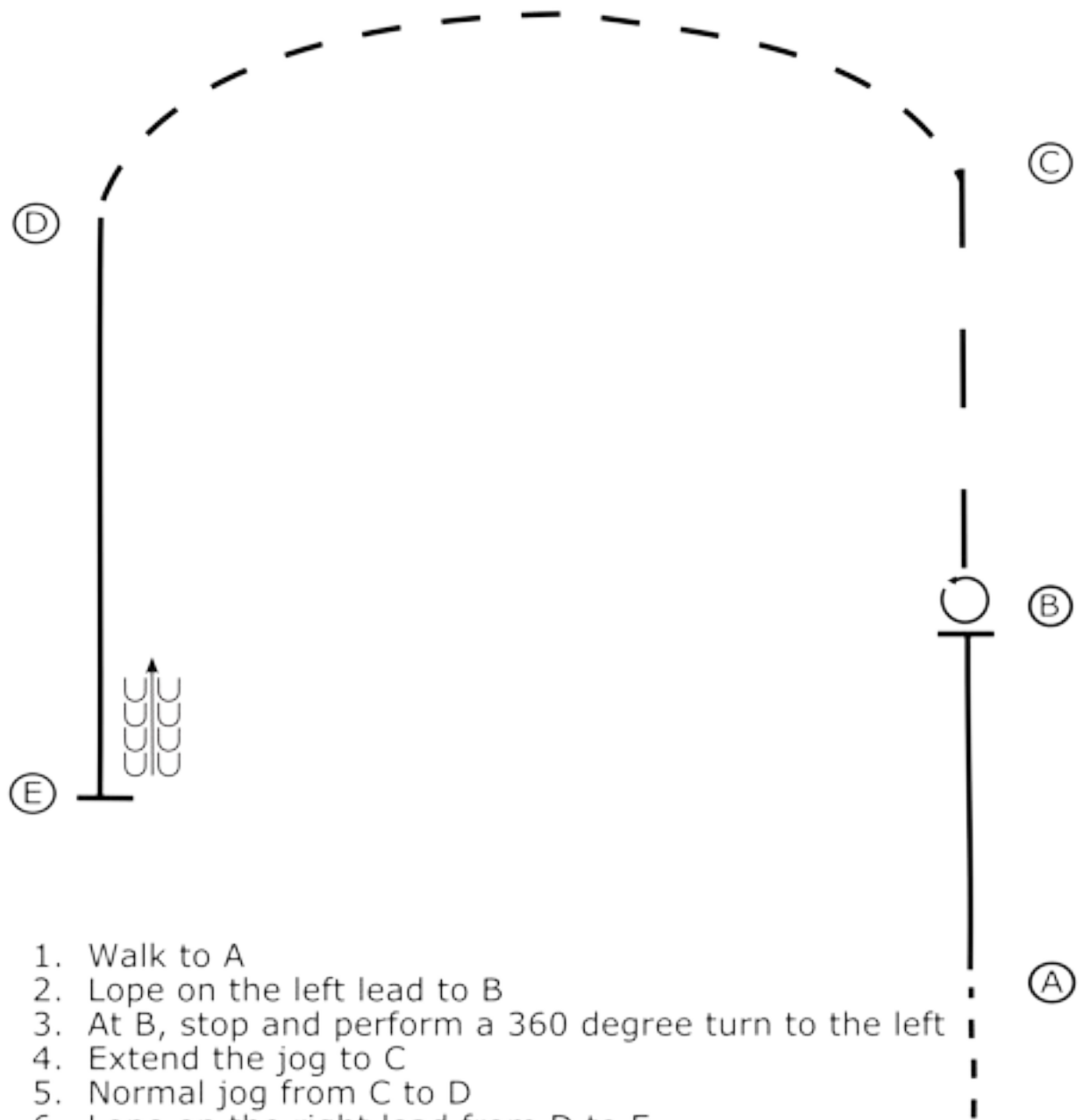

1. Walk to A
2. Lope on the left lead to B
3. At B, stop and perform a 360 degree turn to the left
4. Extend the jog to C
5. Normal jog from C to D
6. Lope on the right lead from D to E
7. At E, stop and back.

Walk ······

Jog - - -

Extended Jog — —

Lope —————

Back ←

Marker (A)

Sapphire/Alumni Pattern 12

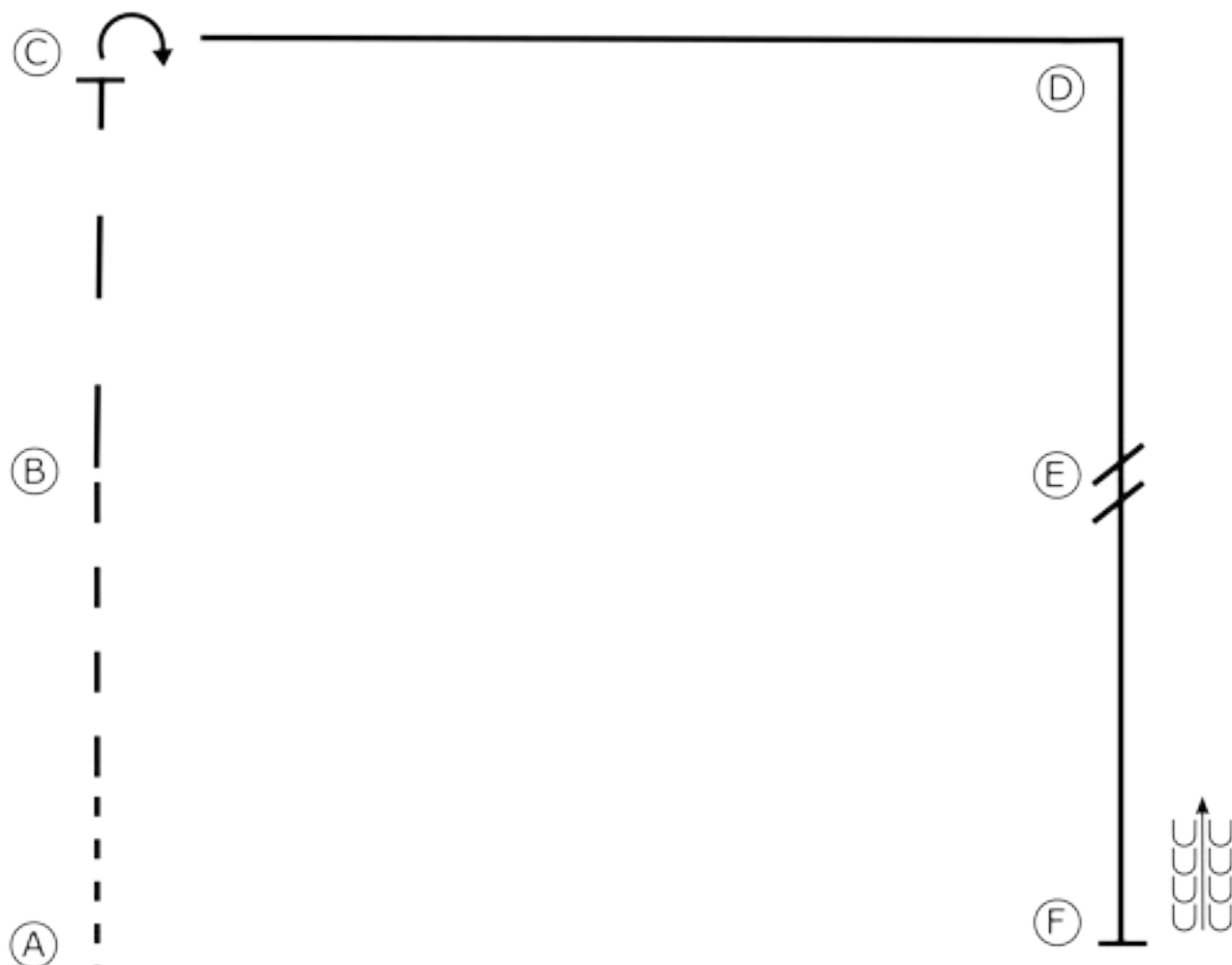

1. Walk to A
2. Walk approximately 2 horse lengths from A
3. Jog to B
4. Extend the jog to C
5. Stop at C and perform a 1/4 turn to the right
6. Lope on the right lead around D and to E
7. Simple lead change at E
8. Lope to F
9. Stop at F and back approximately one horse length.

Walk ······

Jog - - -

Extended Jog — —

Lope —————

Back ← 

Marker (A)

Sapphire/Alumni Pattern 13

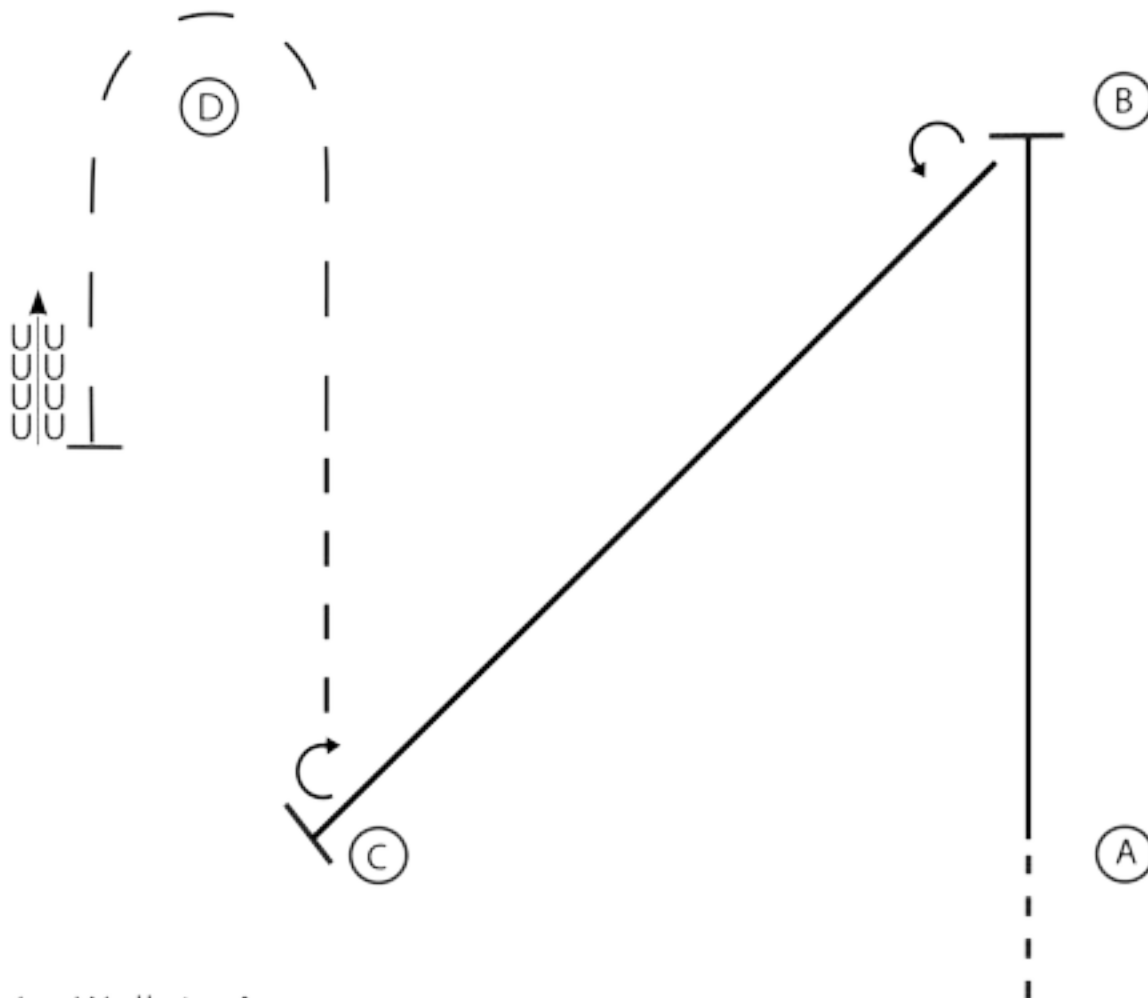

1. Walk to A
2. Lope on the left lead from A to B
3. Stop at B and perform a turn to the left
4. Lope on the right lead to C
5. Stop at C and perform a turn to the right
6. Jog halfway to D
7. When halfway to D, extend the jog to and around D
8. When halfway between D and C stop and back.

Walk ······

Jog - - -

Extended Jog — — —

Lope —————

Back ← 

Marker (A)

Sapphire/Alumni Pattern 14

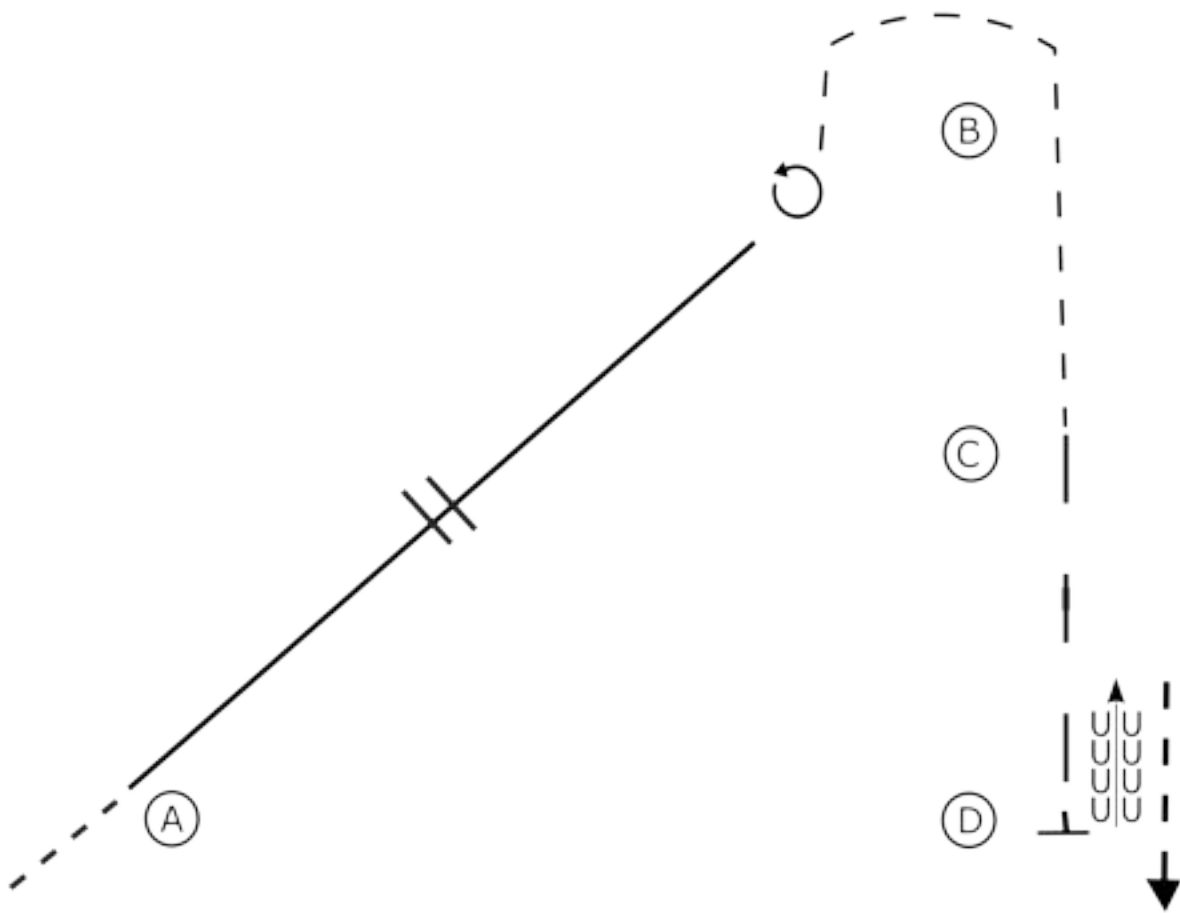

1. Walk to A
2. Lope on the right lead halfway to B
3. Perform a simple lead change
4. Lope on the left lead to B
5. Stop and perform a 405 degree turn to the left
6. Jog a tight turn around B
7. Extend the jog from C to D
8. Stop at D and back approximately one horse length.
9. Walk forward to D and to exit.

Walk ······

Jog - - -

Extended Jog — —

Lope _____

Back ← 

Marker (A)

Sapphire/Alumni Pattern 15

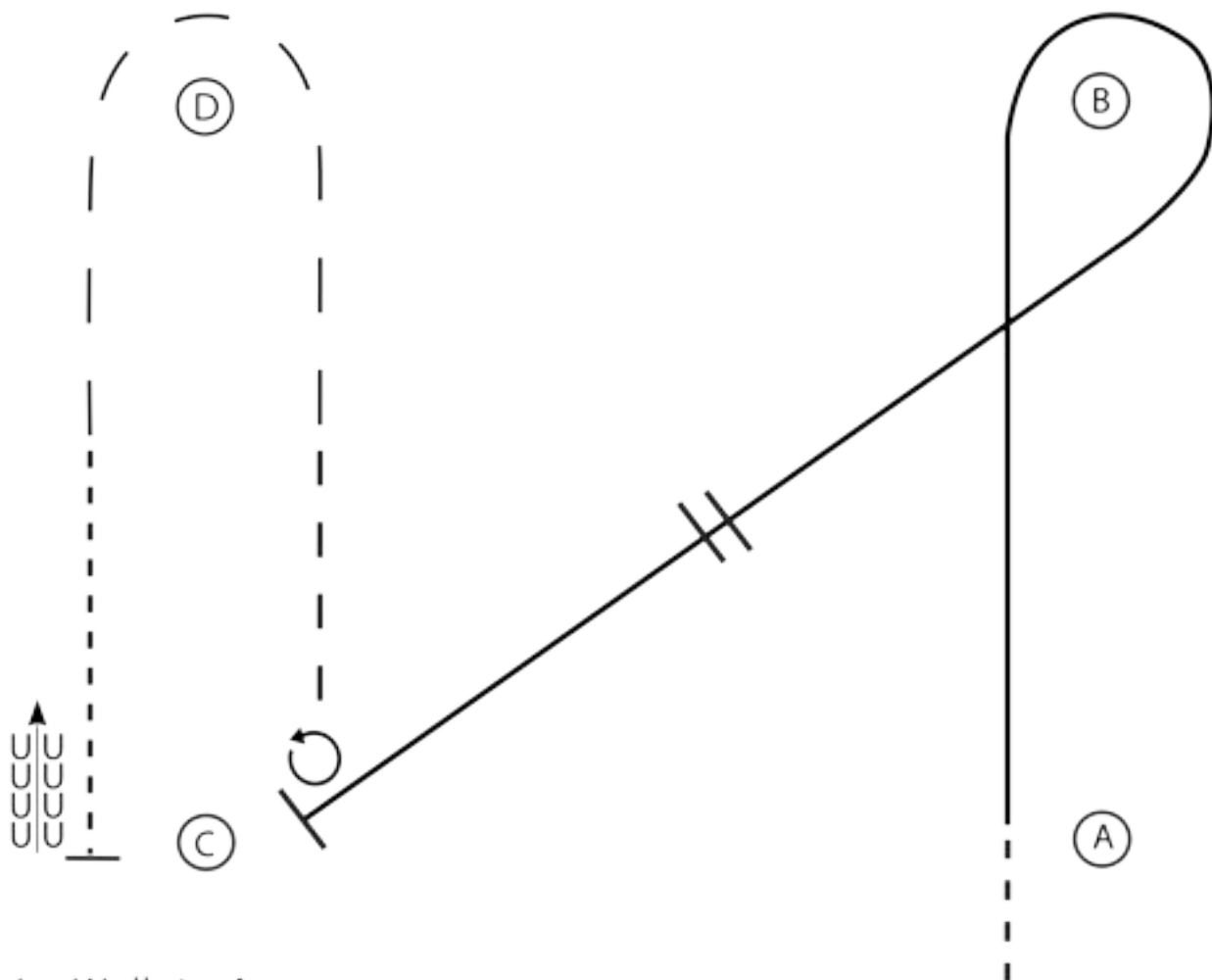

1. Walk to A
2. Lope on the right lead from A to and around B
3. Halfway to C, perform a simple lead change
4. Lope to C
5. Stop and perform a 270 degree turn to the left
6. Jog halfway to D
7. Extend the jog to and around D
8. Halfway to C, break to a walk
9. Stop at C and back approximately one horse length.

Walk ······

Jog - - -

Extended Jog — — —

Lope —————

Back ← ↶ ↷ ↸

Marker (A)

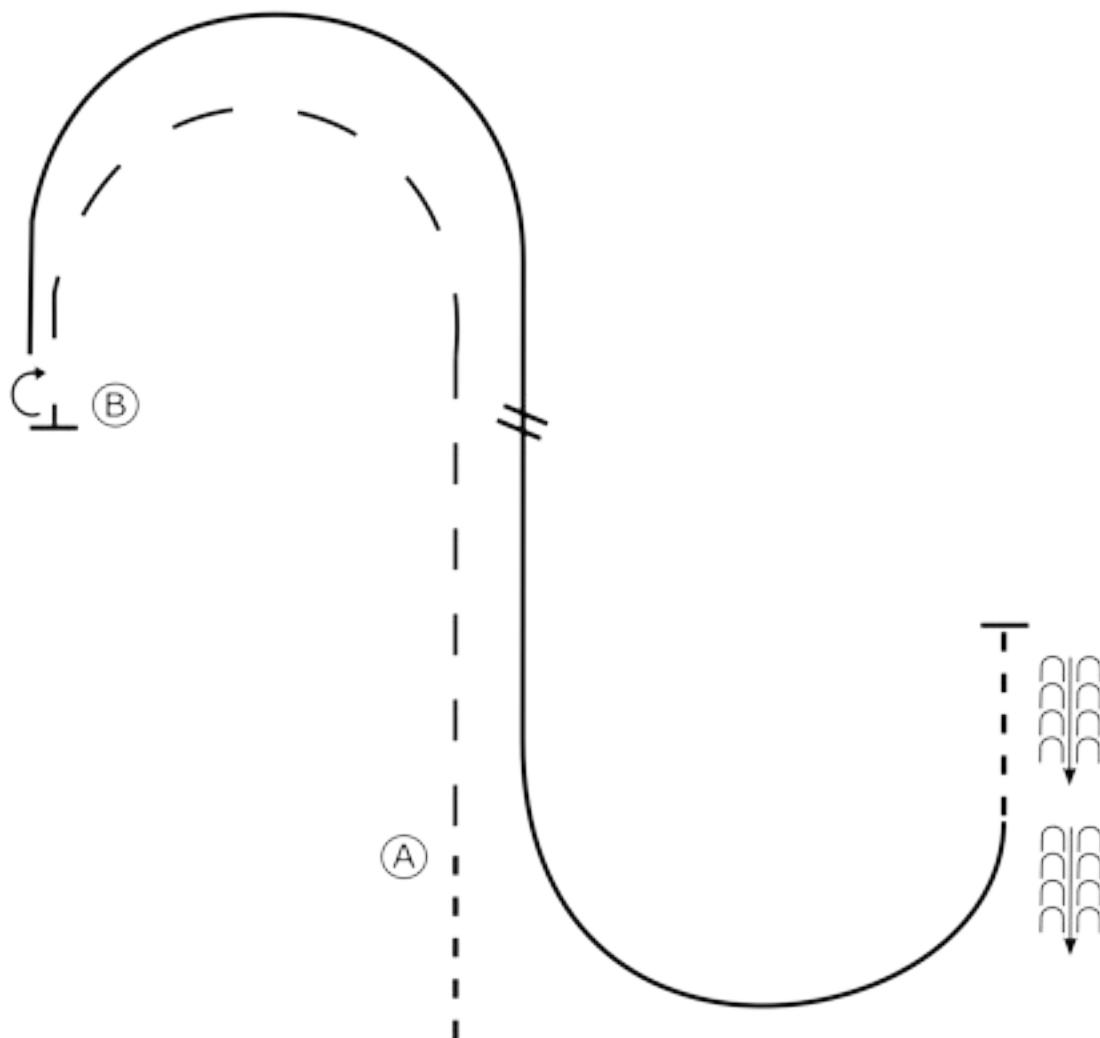

1. Walk to A
2. Jog until even with B
3. Extend the jog in a half circle to B
4. Stop and perform a 180 degree turn to the right
5. Lope a half circle on the right lead until even with B
6. Perform a simple lead change
7. Lope a half circle on the left lead until even with A
8. Walk approximately two horse lengths
9. Stop and back approximately 2 horse lengths.

Walk ······

Jog - - -

Extended Jog — —

Lope _____

Back ←

Marker (A)

Sapphire/Alumni Pattern A

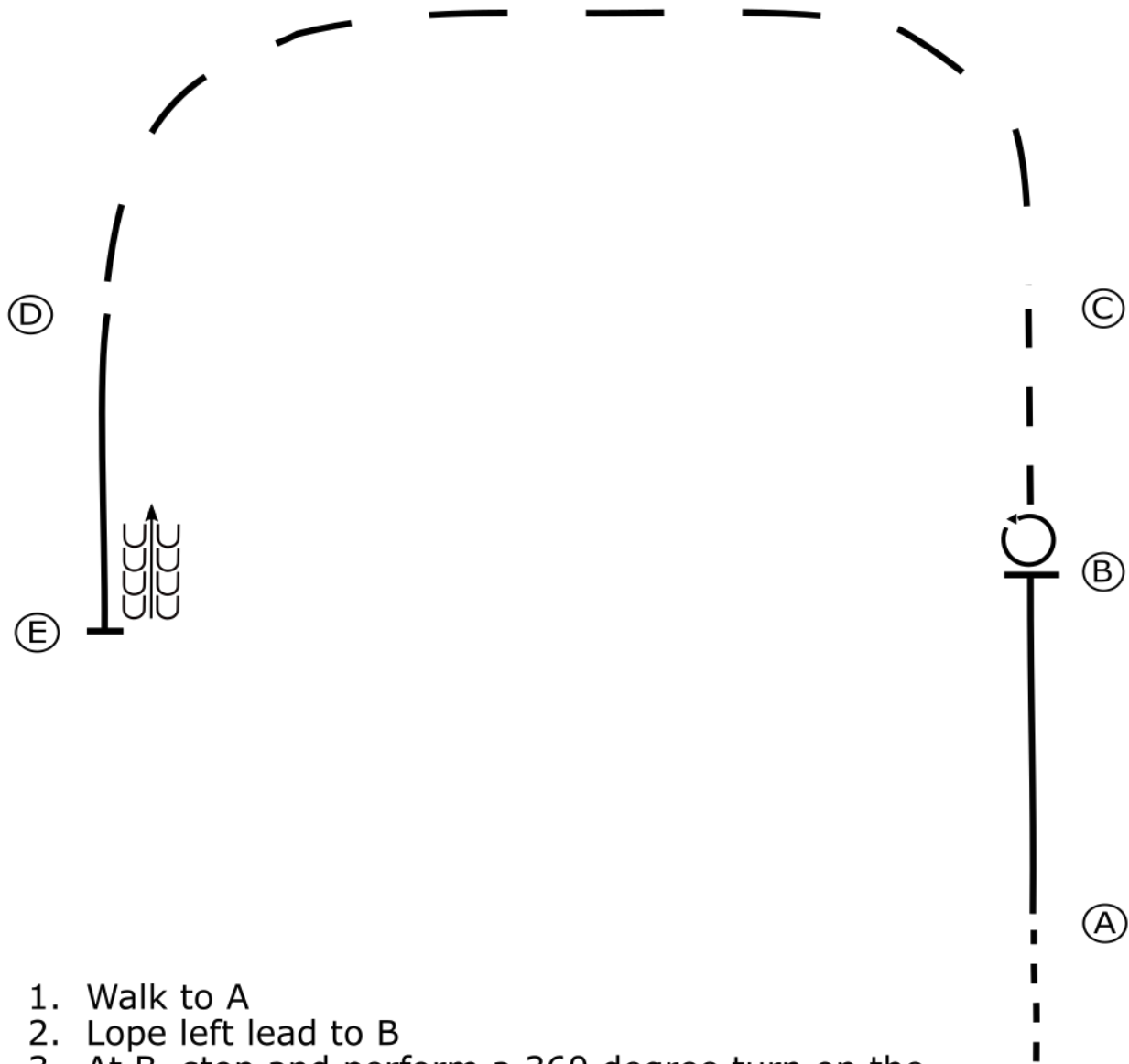

1. Walk to A
2. Lope left lead to B
3. At B, stop and perform a 360 degree turn on the hindquarters to the left
4. Jog to C
5. Extended jog from C to D
6. Lope right lead from D to E
7. At E, stop and back.

Walk
 Jog - - -
 Extended Jog — — —
 Lope —————
 Back ←————→
 Marker (A)

Sapphire/Alumni Pattern B

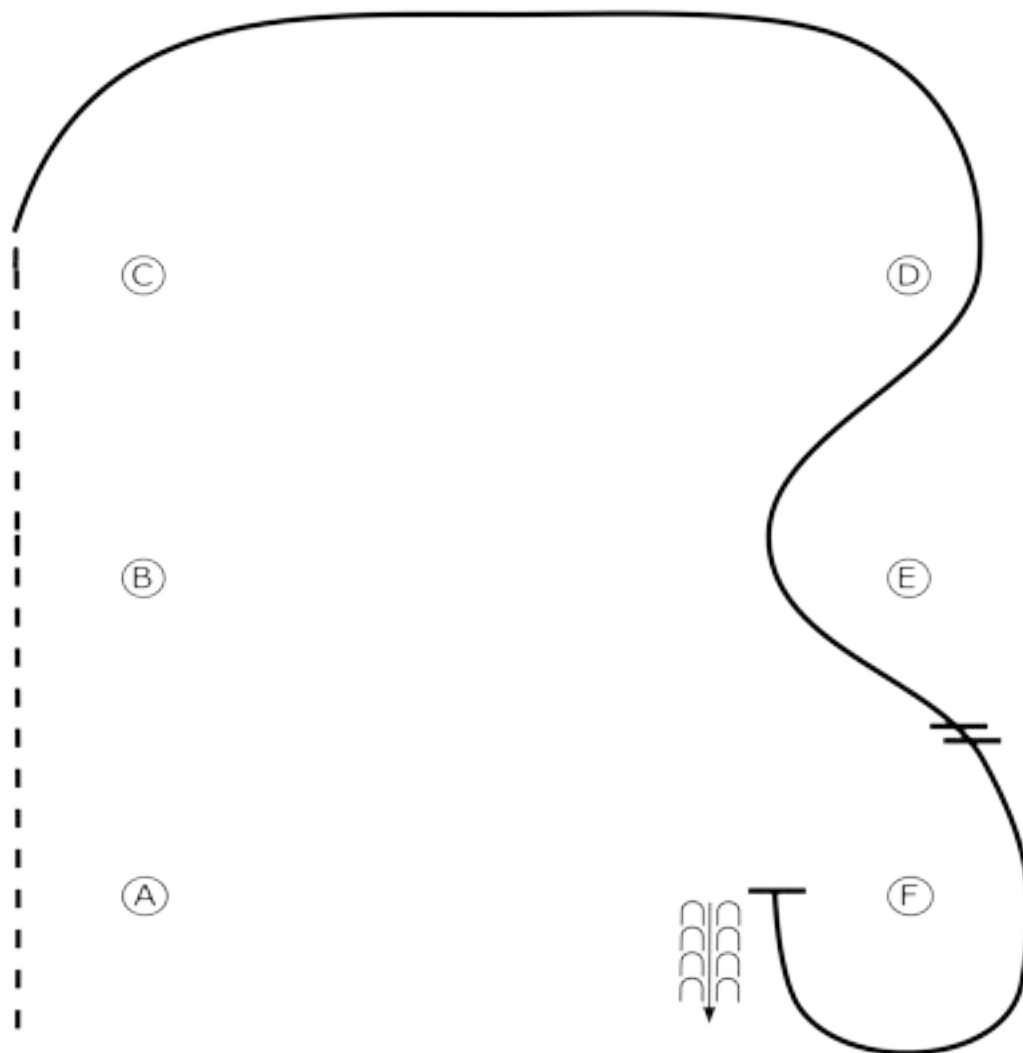

1. Walk to A
2. Walk to B
3. At B, jog to C
4. At C, lope on the left lead around D
5. When between E and F, perform a simple lead change and continue on the right lead around F
6. Stop at F and back 4 steps.

Walk ······

Jog — — —

Extended Jog — — —

Lope —————

Back ← 

Marker (A)

Diamond Pattern 1

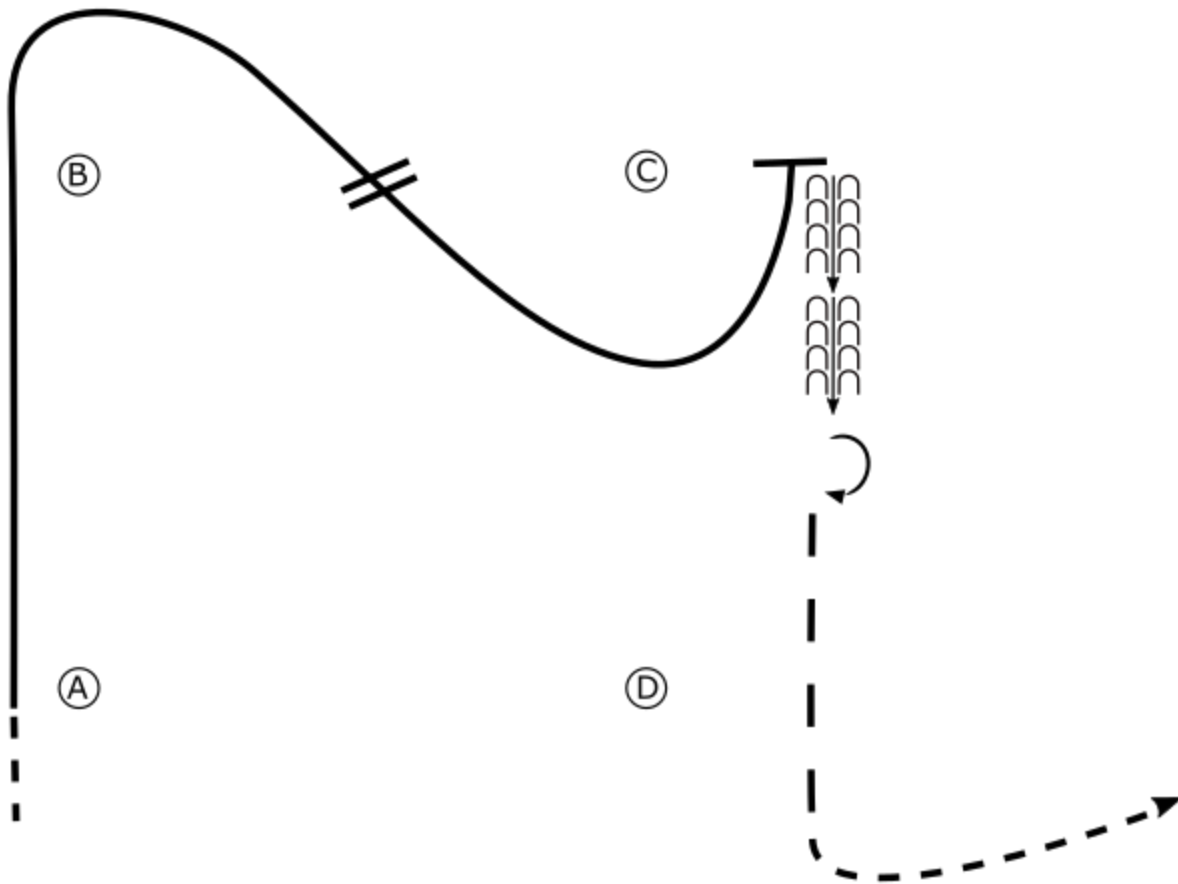

1. Walk to A
2. Lope on the right lead to and around B
3. Perform a simple lead change halfway between B and C
4. Lope of the left lead to C
5. Stop at C
6. Back approximately one horse length
7. Turn 180 degrees to the right
8. Jog to D
9. Walk at D and turn to the left.

Walk ······

Jog - - -

Extended Jog — — —

Lope —————

Back ← 

Marker (A)

Diamond Pattern 2

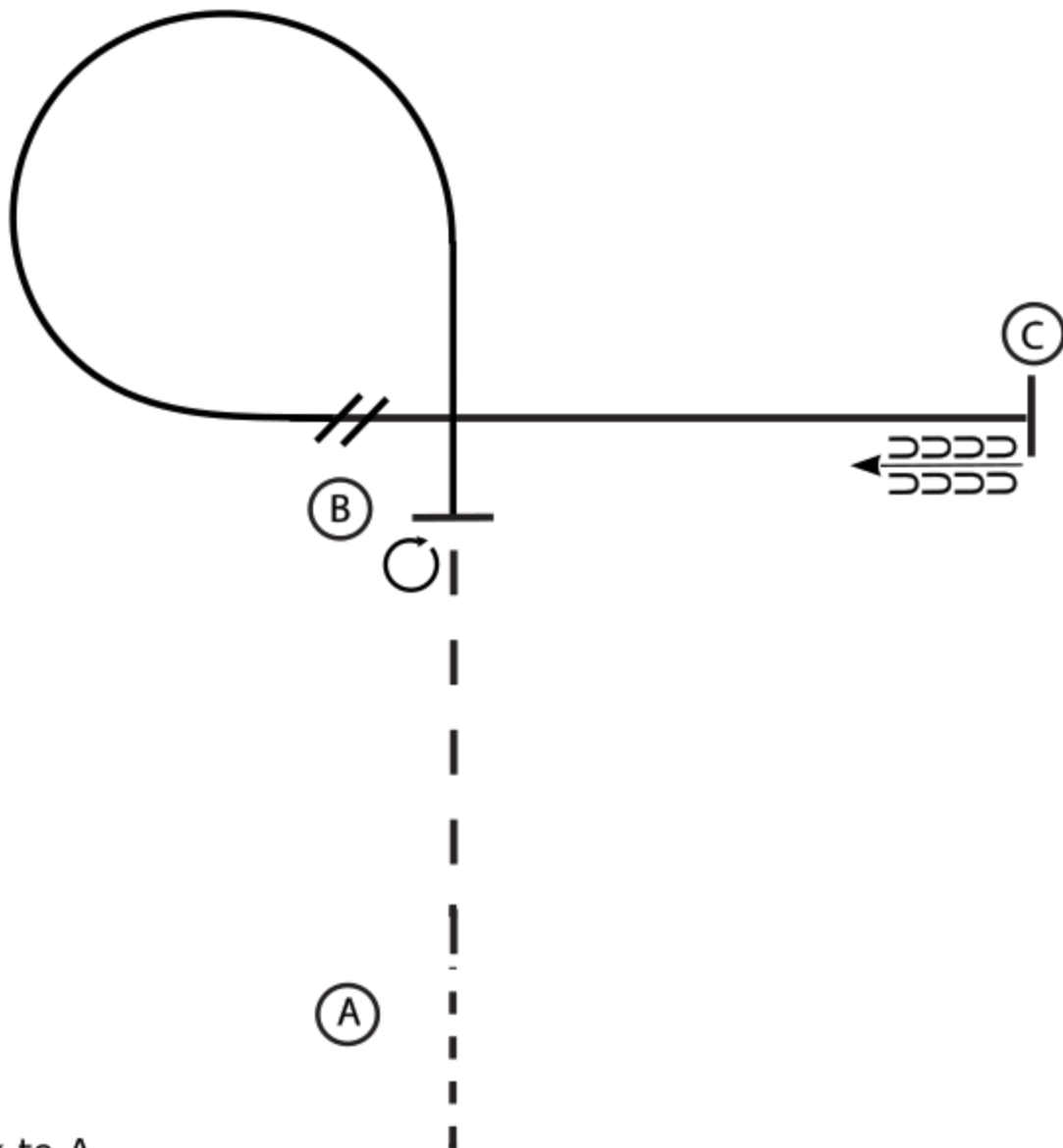

1. Walk to A
2. At A, jog to B
3. Stop at B and perform a 360 degree turn to the right
4. Lope a left lead circle to the left
5. When even with B, perform a simple lead change and continue to C
6. At C, stop and back 5 steps.

Walk ······

Jog - - -

Extended Jog — —

Lope —————

Back ←

Marker (A)

Diamond Pattern 3

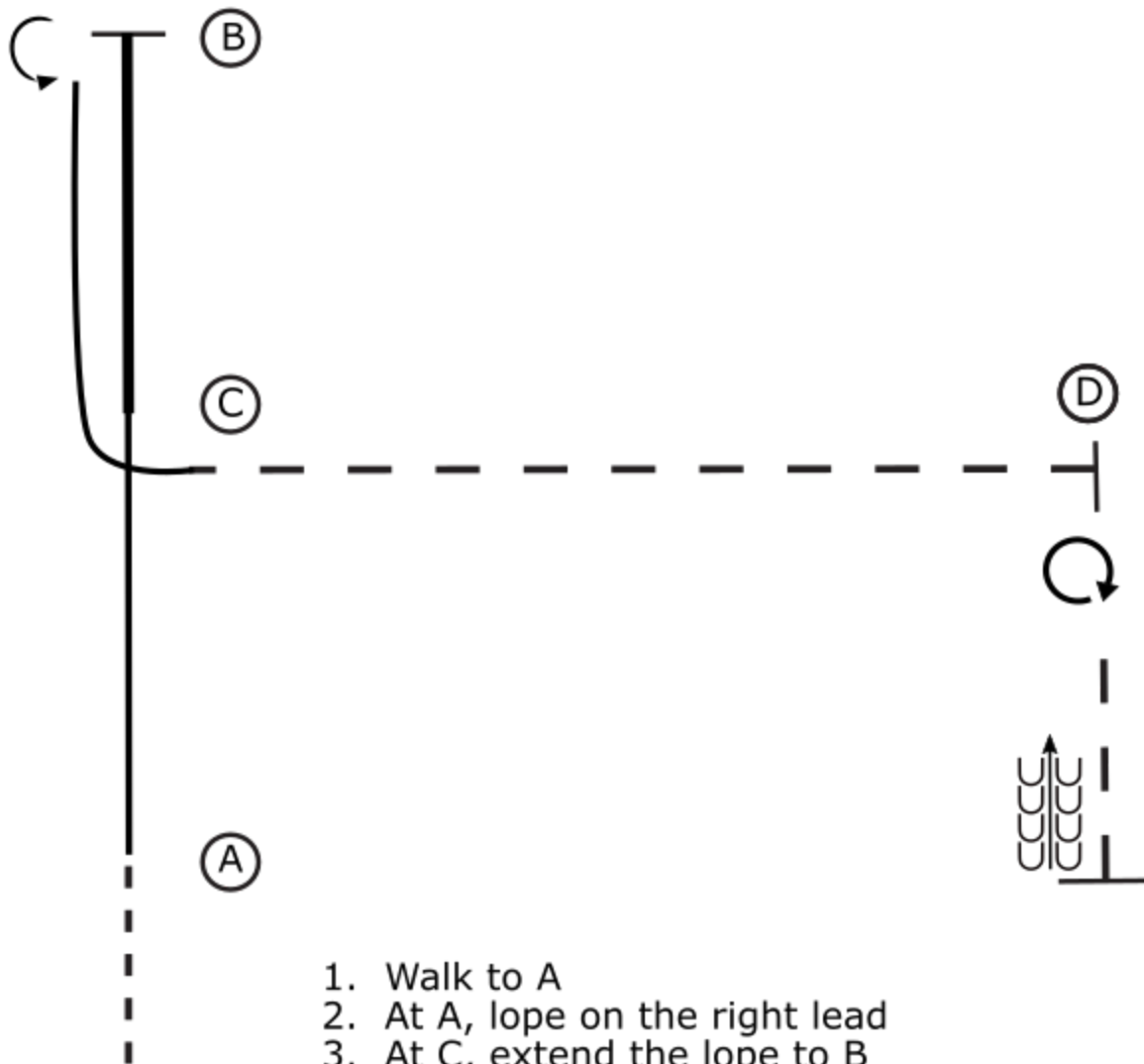

1. Walk to A
2. At A, lope on the right lead
3. At C, extend the lope to B
4. Stop at B and perform a 180 degree turn to the left on the hindquarters
5. Lope around C
6. At C, jog to D
7. Stop at D and perform a 450 degree turn to the right on the hindquarters
8. Extend the jog until even with A
9. Stop when even with A and back.

Walk

Jog - - -

Extended Jog — — —

Lope —————

Back ← 

Marker (A)

Diamond Pattern 4

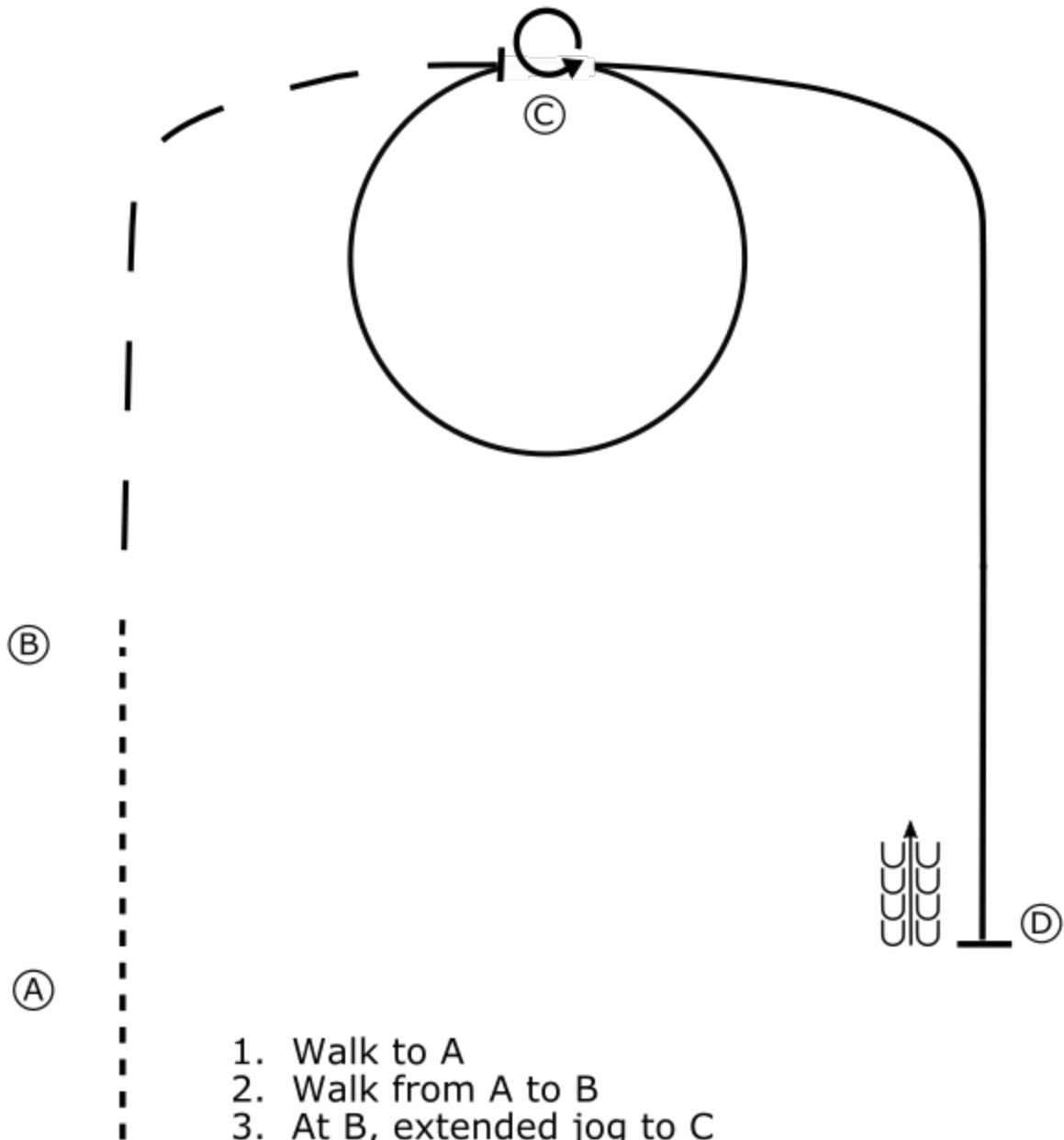

1. Walk to A
2. Walk from A to B
3. At B, extended jog to C
4. At C, lope a circle to the right on the right lead
5. Stop at C and turn 360 degrees to the left
6. Lope on the left lead to D
7. Stop at D and back one horse length.

Walk ······

Jog - - -

Extended Jog — — —

Lope —————

Back ←

Marker (A)

Diamond Pattern 5

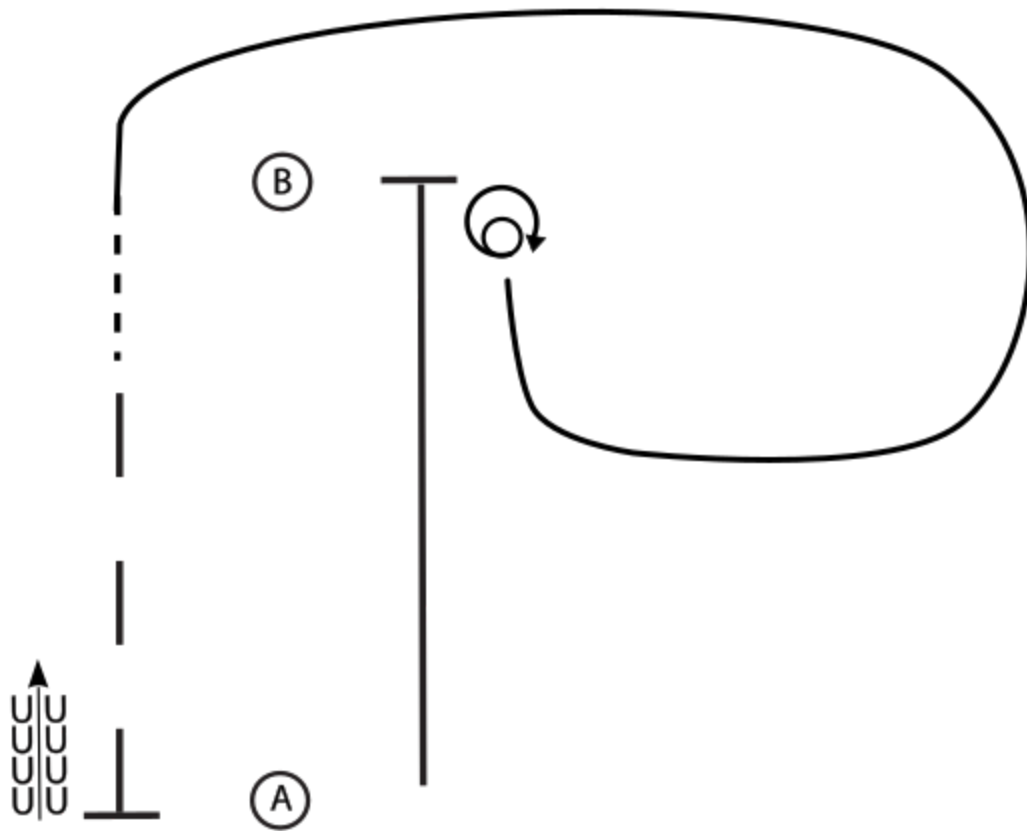

1. Walk to A
2. Lope on the right lead to B
3. Turn 1 1/2 turns to the right
4. Lope on the left lead back around to B
5. At B, break to the walk
6. Walk approximately 10 feet
7. Extended jog to A
8. Stop at A and back approximately one horse length.

Walk

Jog - - -

Extended Jog — —

Lope ———

Back ←

Marker (A)

Diamond Pattern 8

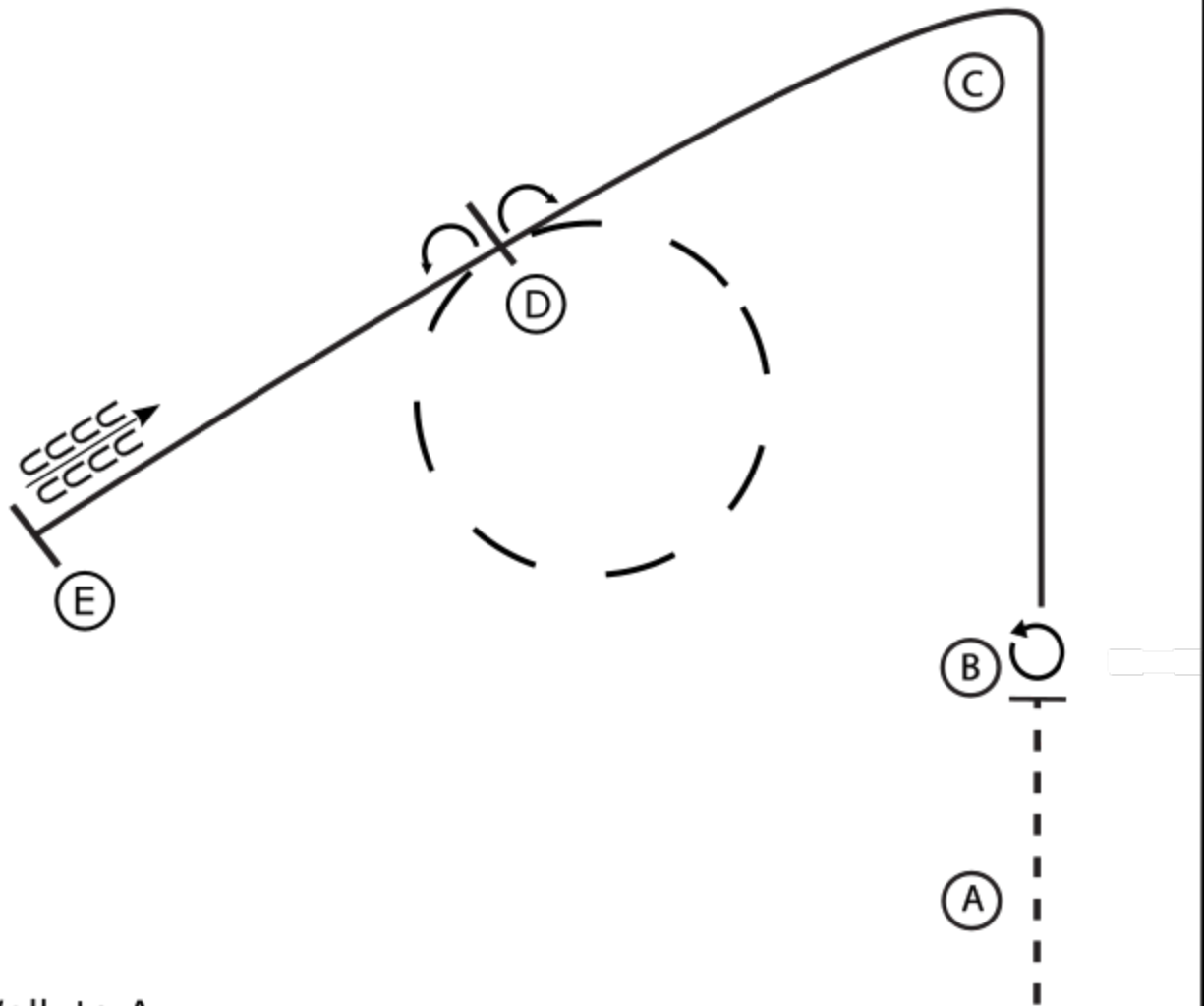

1. Walk to A
2. At A, jog to B
3. Stop at B and perform a 360 degree turn to the left
4. Lope on the left lead around C to D
5. Stop at D and a 180 degree turn to the right
6. Extend the jog in a circle around D
7. Stop at D and perform a 180 degree turn to the left
8. Lope on the left lead to E
9. Stop at E and back 4 steps.

Walk ······

Jog - - -

Extended Jog — — —

Lope —————

Back ←

Marker (A)

Diamond Pattern 9

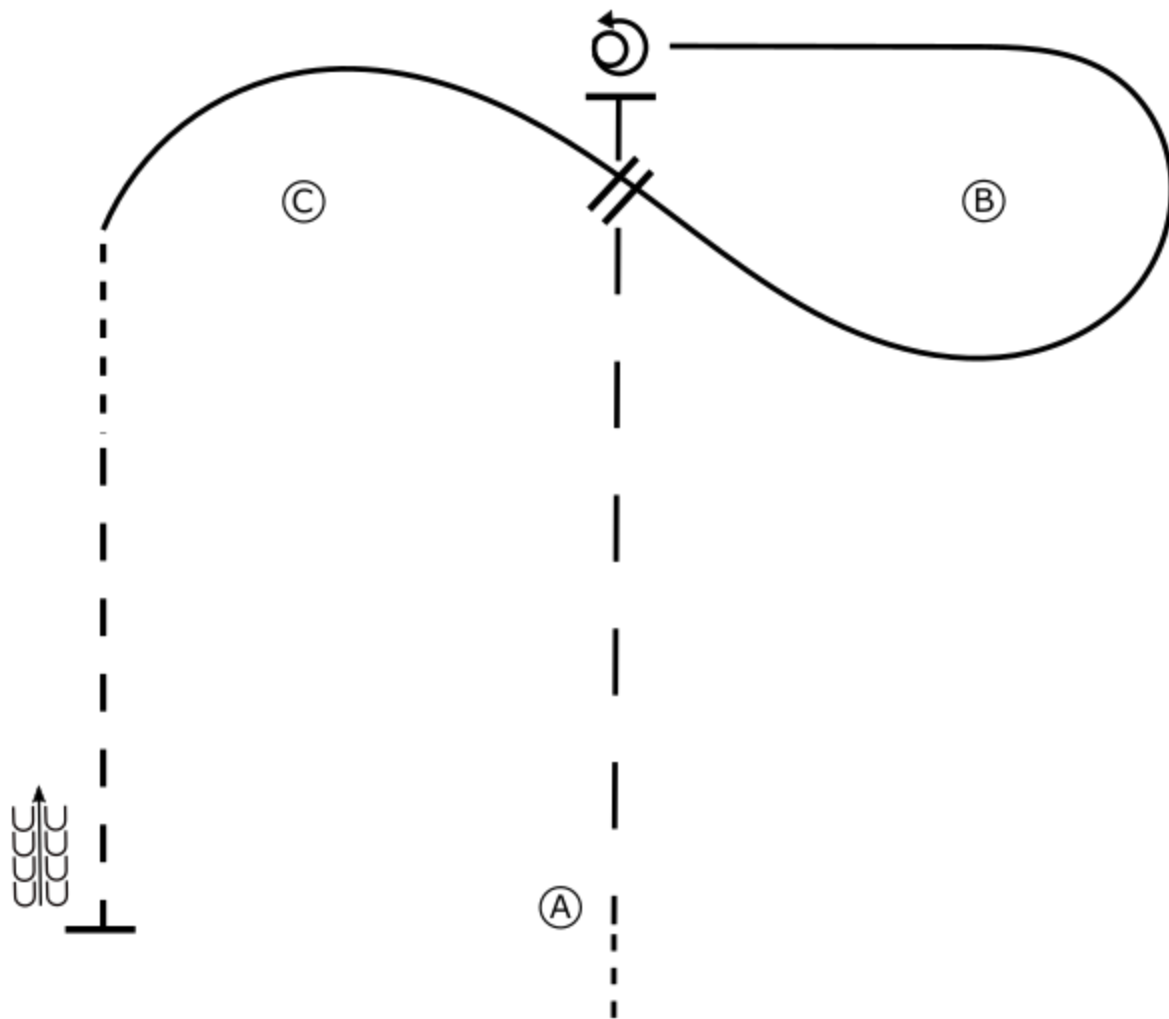

1. Walk to A
2. Extend the jog until just past B and C
3. Stop and perform a 1 3/4 turn to the left
4. Lope on the right lead around B
5. Perform a simple lead change halfway to C and lope around C
6. Break to a walk for 2 strides
7. Jog until even with A
8. Stop and back approximately one horse length and walk to exit.

Walk ······

Jog - - -

Extended Jog — —

Lope —————

Back ←

Marker (A)

Diamond Pattern 10

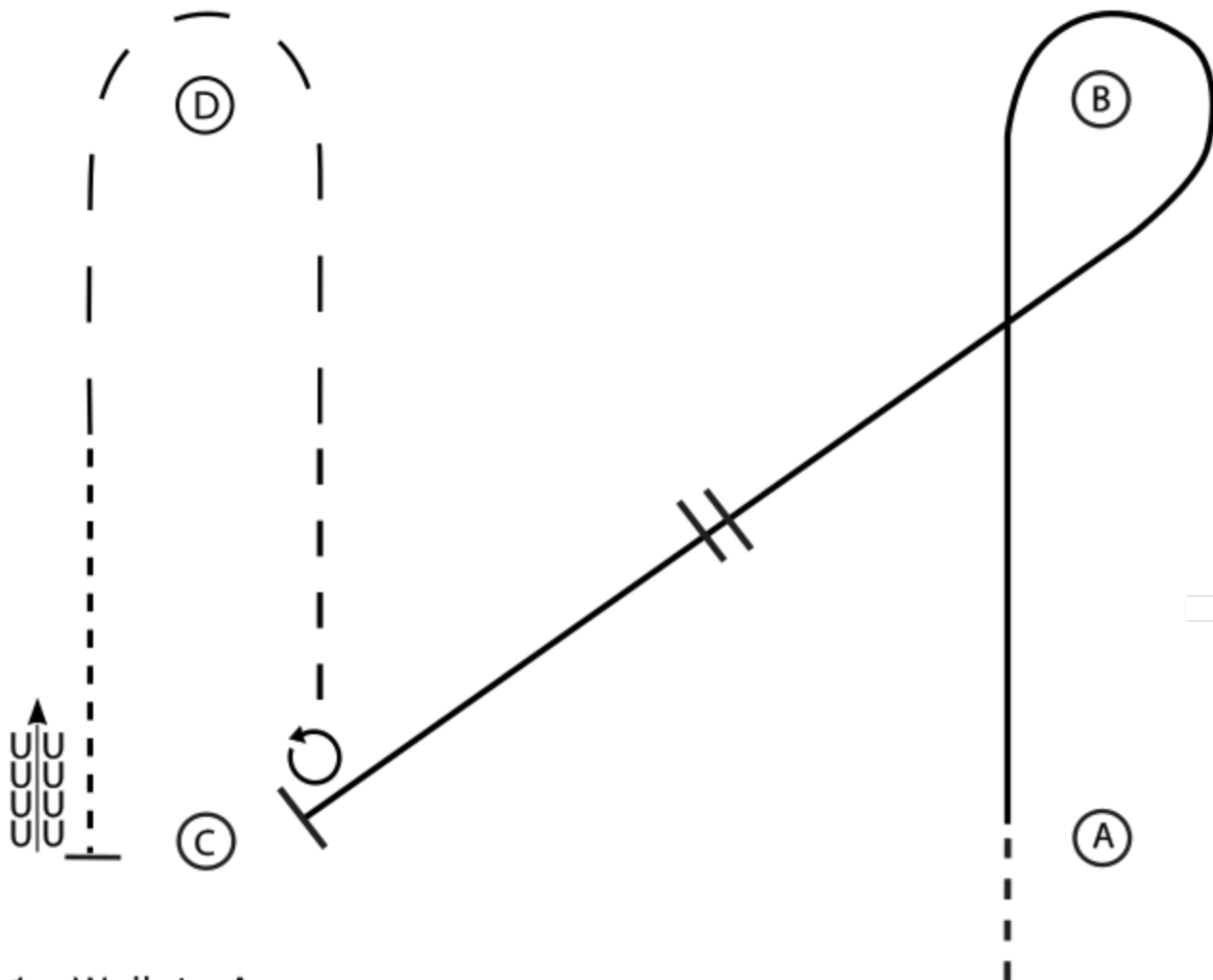

1. Walk to A
2. Lope on the right lead from A to and around B
3. Halfway to C, perform a simple lead change
4. Lope to C
5. Stop and perform a 270 degree turn to the left
6. Jog halfway to D
7. Extend the jog to and around D
8. Halfway to C, break to a walk
9. Stop at C and back approximately one horse length.

Walk ······

Jog - - -

Extended Jog — — —

Lope —————

Back ←

Marker (A)

Diamond Pattern 11

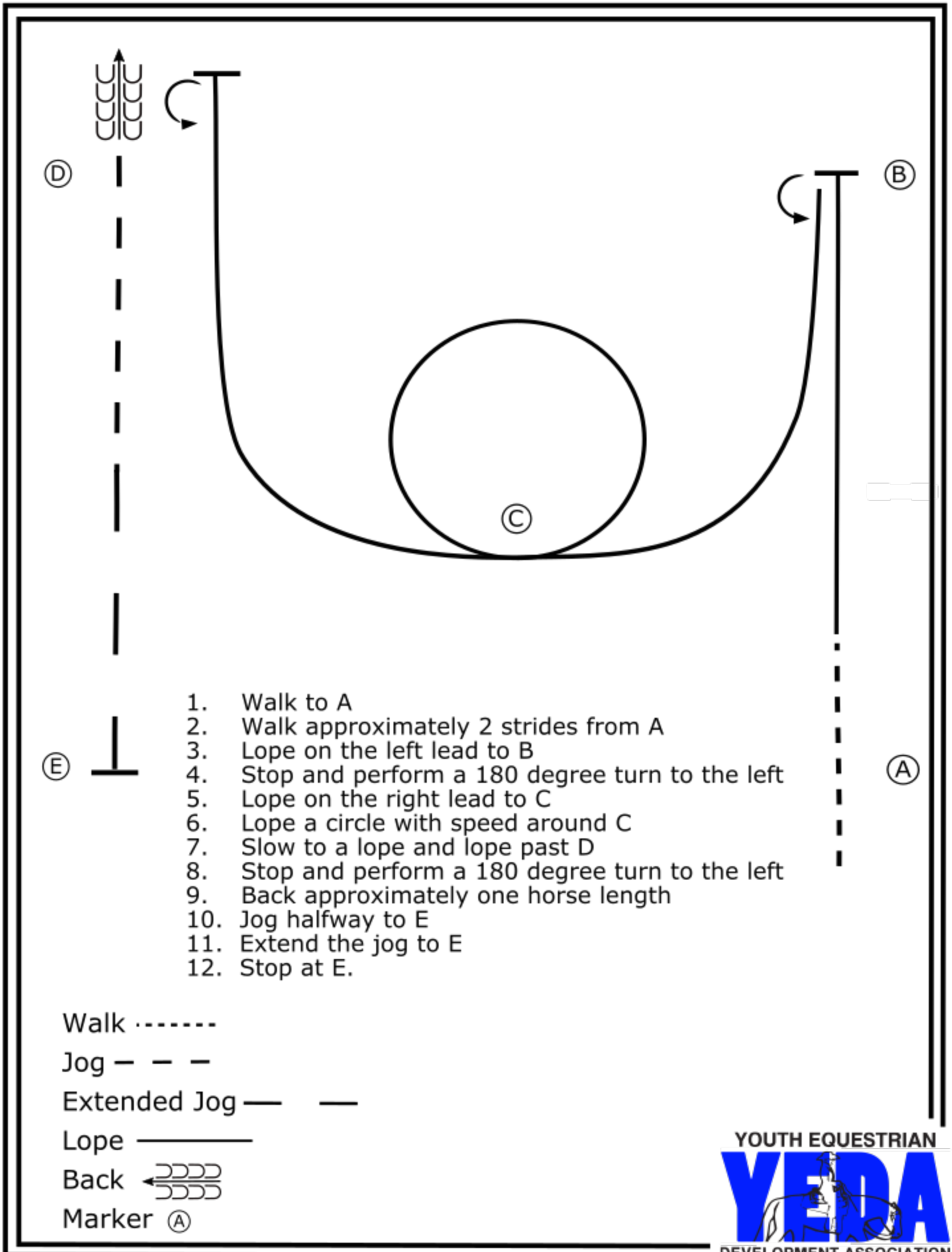

1. Walk to A
2. Walk approximately 2 strides from A
3. Lope on the left lead to B
4. Stop and perform a 180 degree turn to the left
5. Lope on the right lead to C
6. Lope a circle with speed around C
7. Slow to a lope and lope past D
8. Stop and perform a 180 degree turn to the left
9. Back approximately one horse length
10. Jog halfway to E
11. Extend the jog to E
12. Stop at E.

Walk ······

Jog - - -

Extended Jog — — —

Lope —————

Back ←

Marker (A)

Diamond Pattern 12

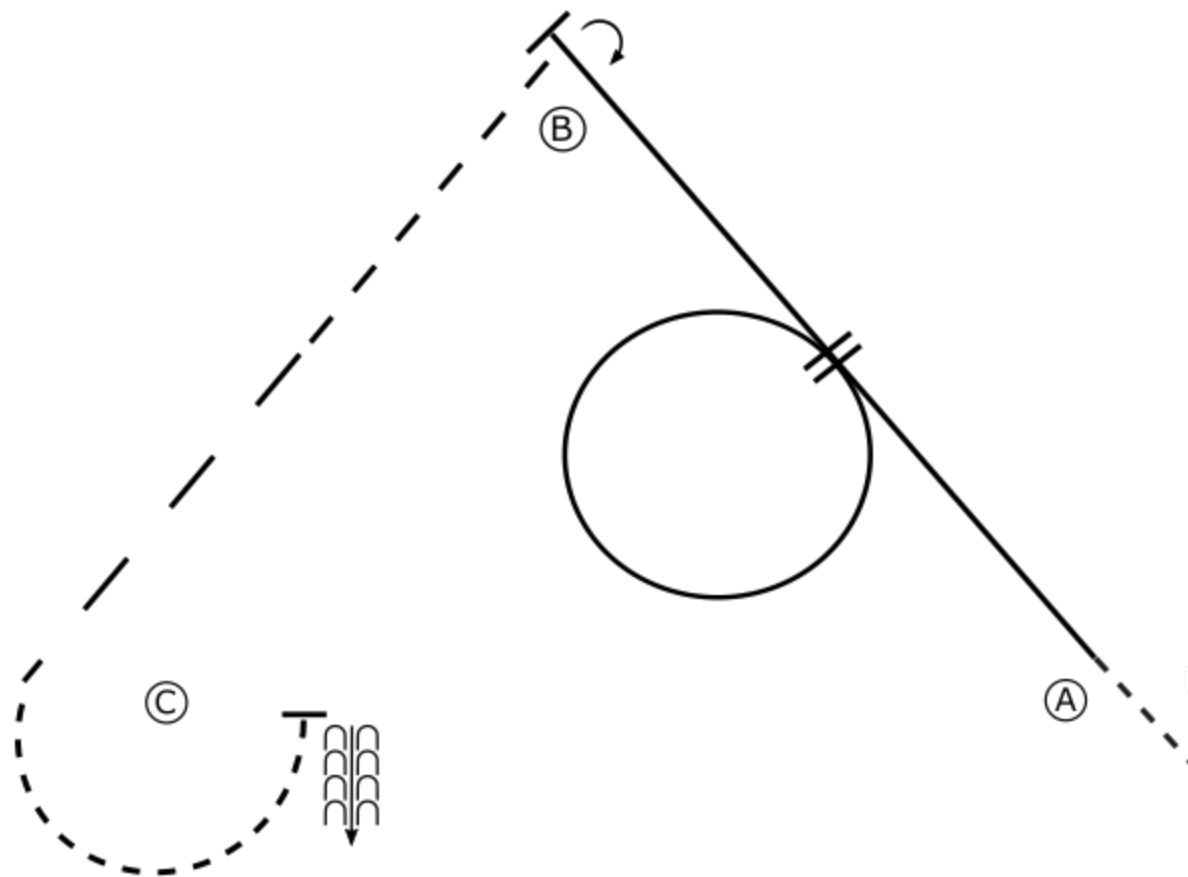

1. Walk to A
2. Lope on the left lead towards B
3. Halfway between A and B, lope a circle to the left on the left lead
4. Halfway between A and B, perform a simple lead change
5. Lope past B. Stop and perform a 225 degree turn to the right
6. Jog towards C
7. Halfway between B and C, extend the jog
8. At C, break to a walk and walk around C
9. At C, stop and back approximately one horse length.

Walk ······

Jog - - -

Extended Jog — — —

Lope —————

Back ←

Marker (A)

Diamond Pattern 13

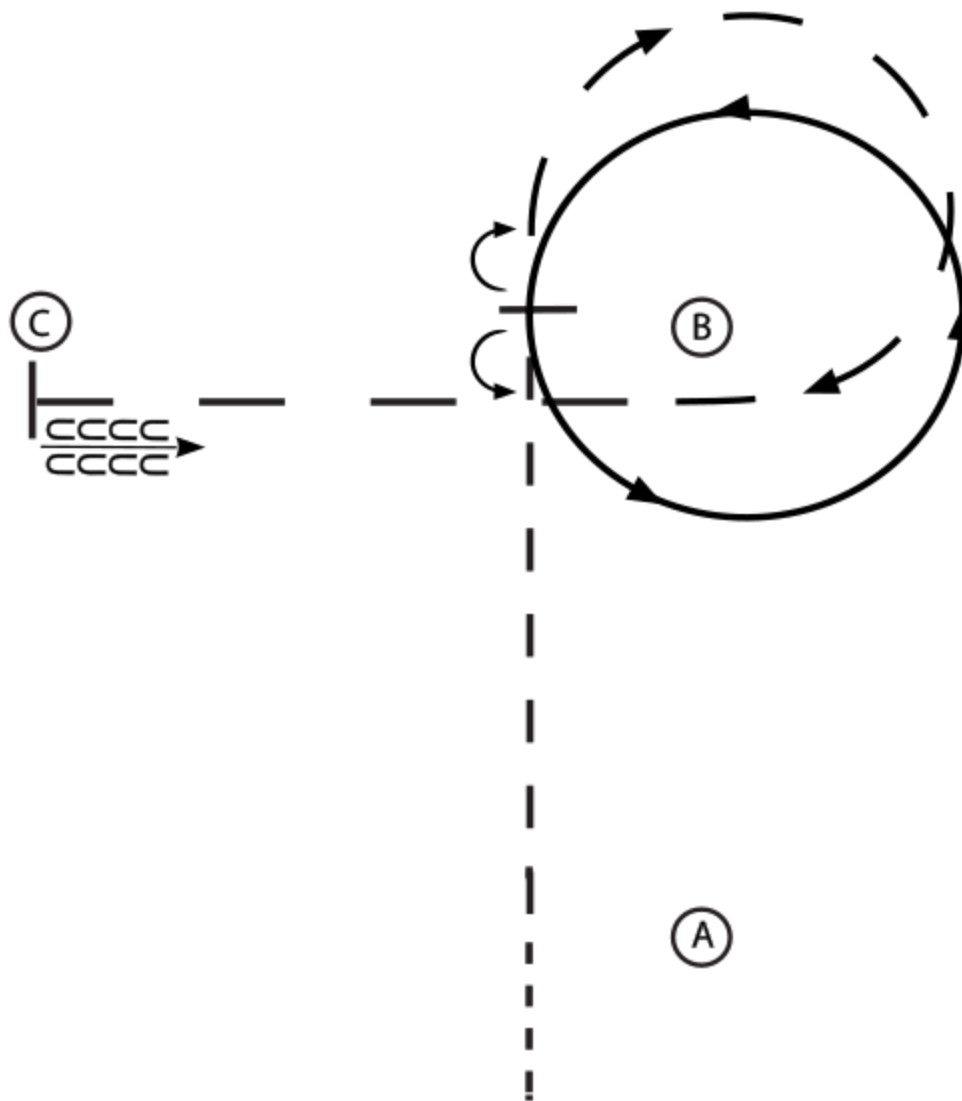

1. Walk to A
2. Jog A to B
3. Stop at B and perform a 180 degree turn to the left
4. Lope a circle around B on the left lead
5. Stop at B and perform a 180 degree turn to the right
6. Extend the jog in a circle around B and continue to C
7. Stop at C and back approximately one horse length.

Walk ······

Jog - - -

Extended Jog — —

Lope _____

Back ← 

Marker (A)

Diamond Pattern 15

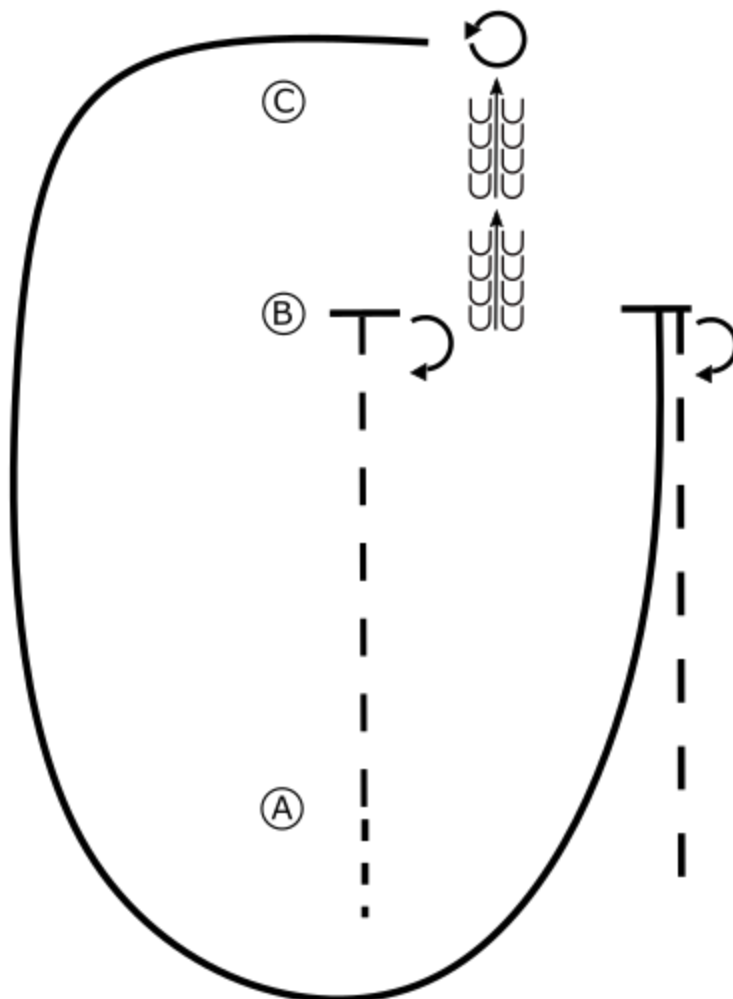

1. Walk to A
2. Jog A to B
3. Stop at B and perform a 180 degree turn to the right
4. Back to C
5. At C, perform a 270 degree turn to the left
6. Lope a circle around A, returning to B
7. Stop at B and perform a 180 degree turn to the right
8. Jog past A.

Pattern is over once you pass A.

Walk ······

Jog - - -

Extended Jog — —

Lope —————

Back ←

Marker (A)

Diamond Pattern 16

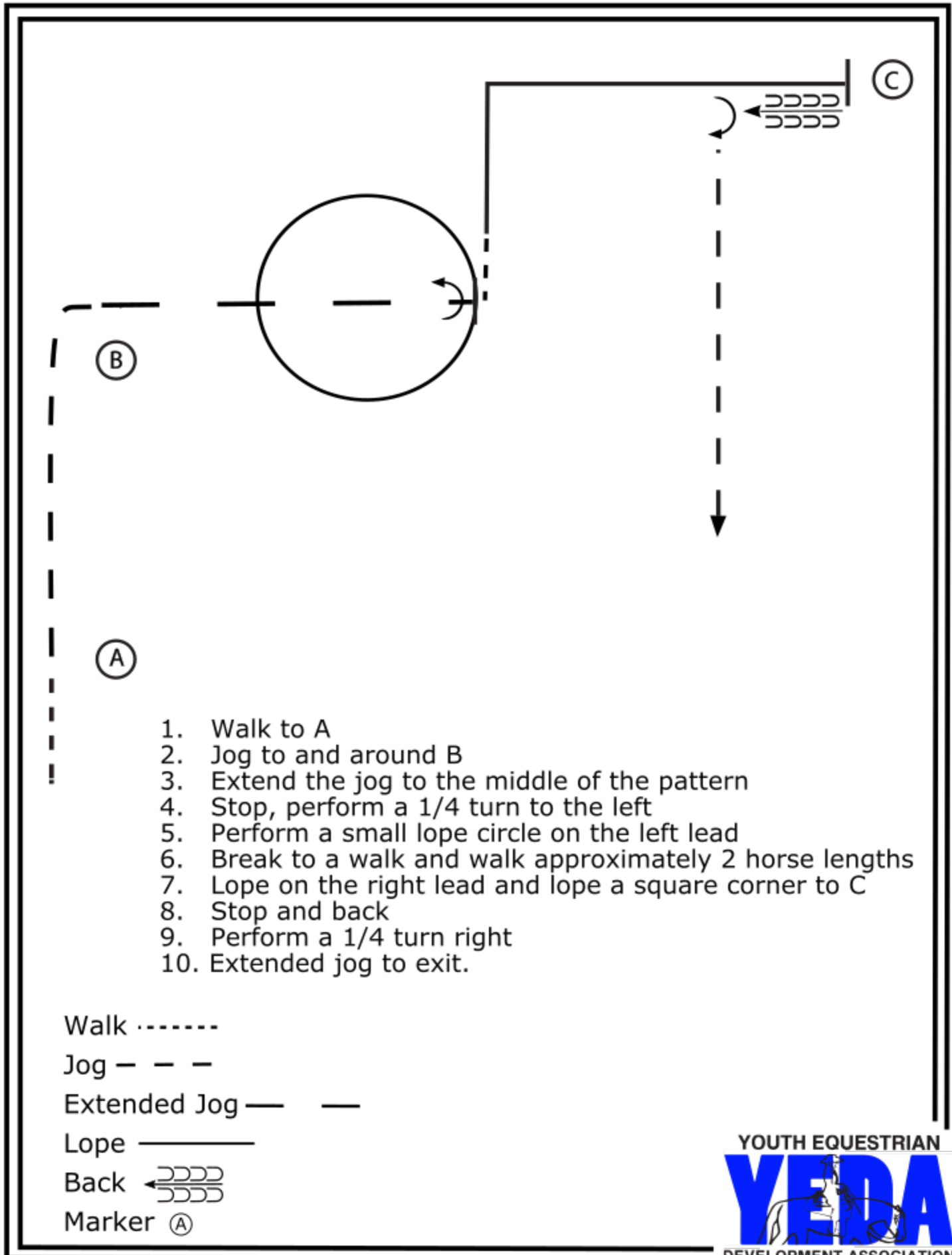

1. Walk to A
2. Jog to and around B
3. Extend the jog to the middle of the pattern
4. Stop, perform a 1/4 turn to the left
5. Perform a small lope circle on the left lead
6. Break to a walk and walk approximately 2 horse lengths
7. Lope on the right lead and lope a square corner to C
8. Stop and back
9. Perform a 1/4 turn right
10. Extended jog to exit.

Walk ······

Jog - - -

Extended Jog — — —

Lope —————

Back ←

Marker (A)

Diamond Pattern A

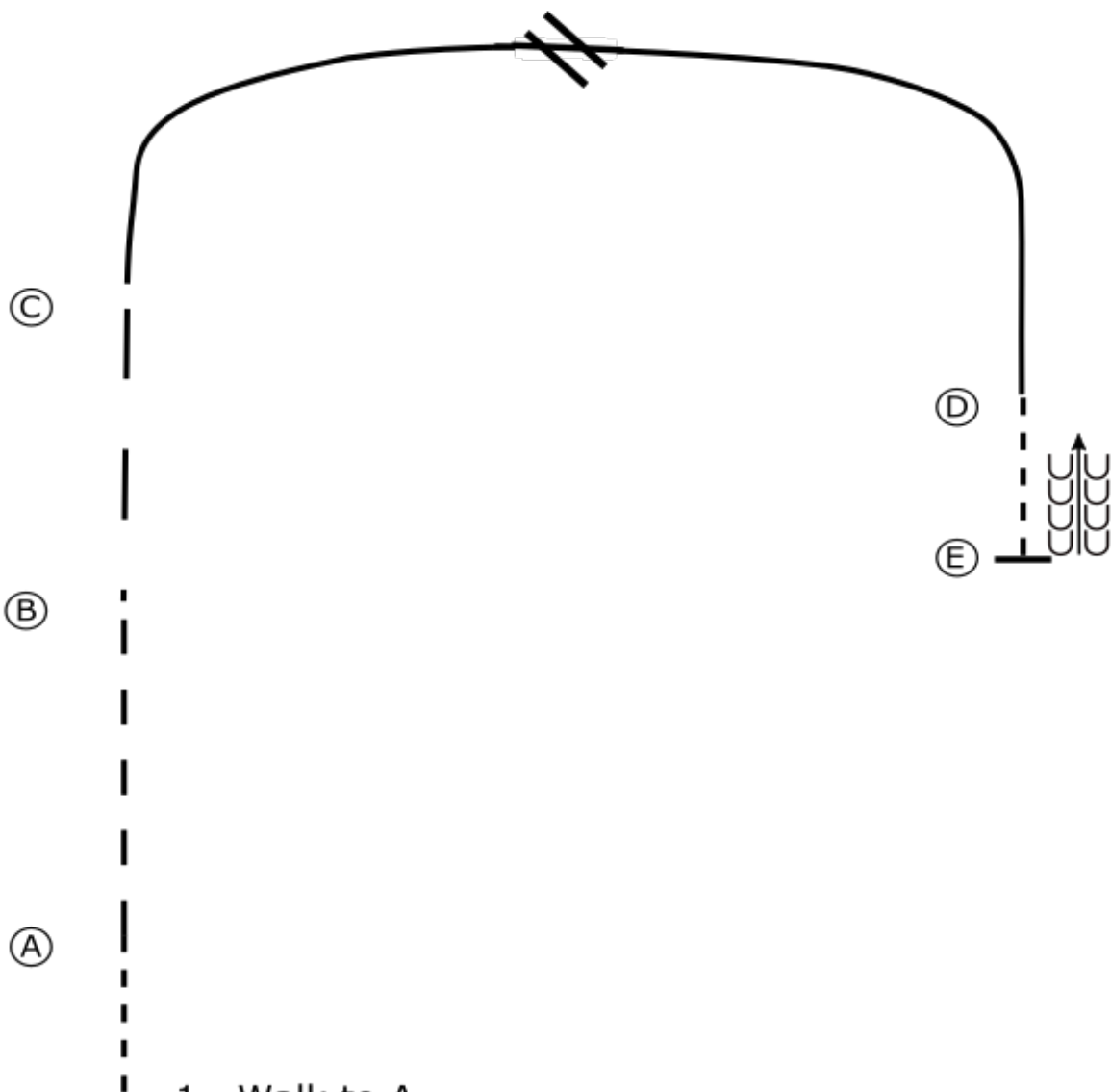

1. Walk to A
2. Jog to B
3. Perform an extended jog from B to C
4. Lope on the left lead toward D
5. Halfway to D, perform a simple lead change
6. Lope on the right lead to D
7. Walk from D to E
8. Stop and and back apprxoimately one horse length.

Walk
 Jog - - -
 Extended Jog — —
 Lope _____
 Back ← 
 Marker (A)

Ranch Riding Pattern 1

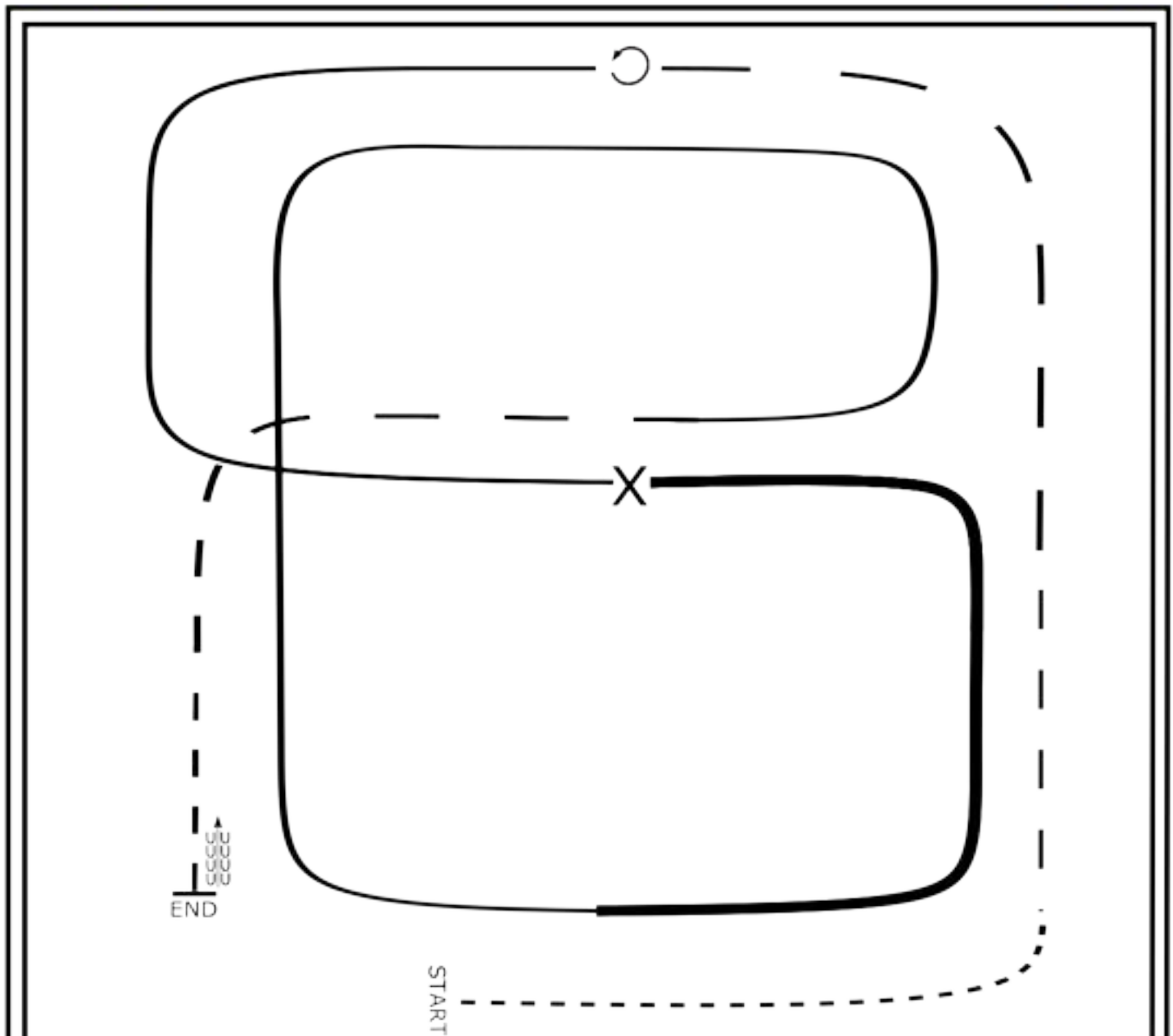

1. Walk
2. Trot
3. Extended Trot
4. Stop, turn 360 Left
5. Lope Left Lead
6. Change Leads
7. Extended Lope Right Lead
8. Return to normal lope
9. Extended Trot
10. Trot
11. Stop, Back

Ranch Riding Pattern 3

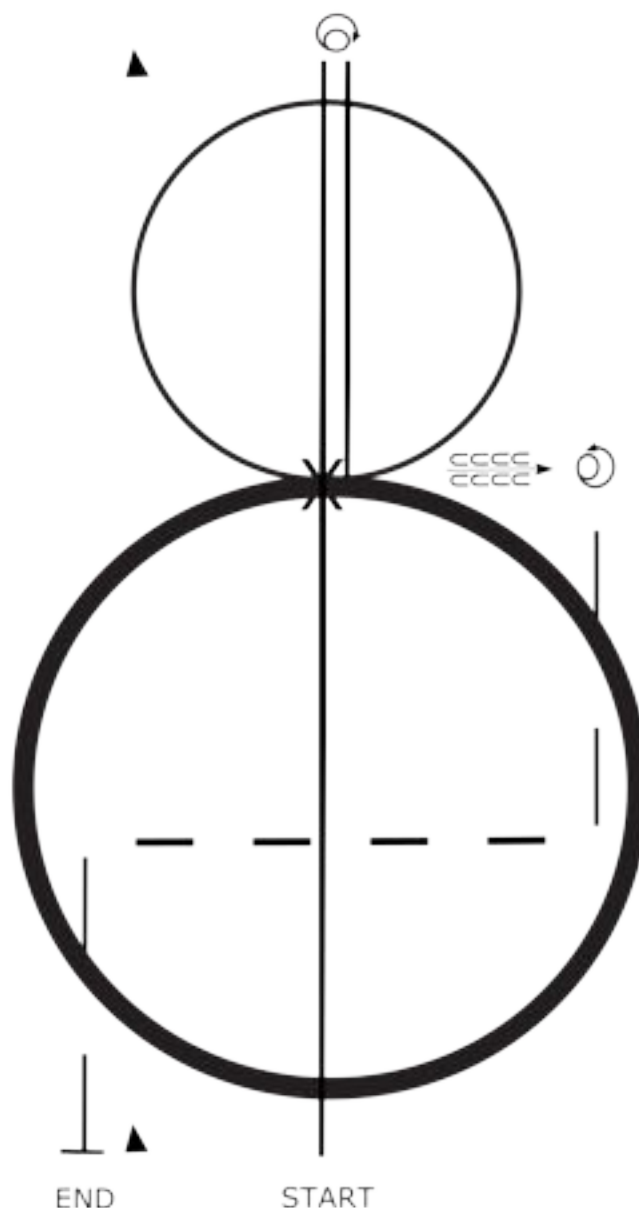

1. Lope left lead down the center past end marker and stop
2. 1 1/2 spins right
3. Lope right lead to center and continue loping a small slow circle to the right
4. Change leads
5. Lope large fast circle to the left
6. Stop, back 6 steps
7. Turn 1 1/4 spins left
8. Extended trot and stop even with the end cone.

Ranch Riding Pattern 4

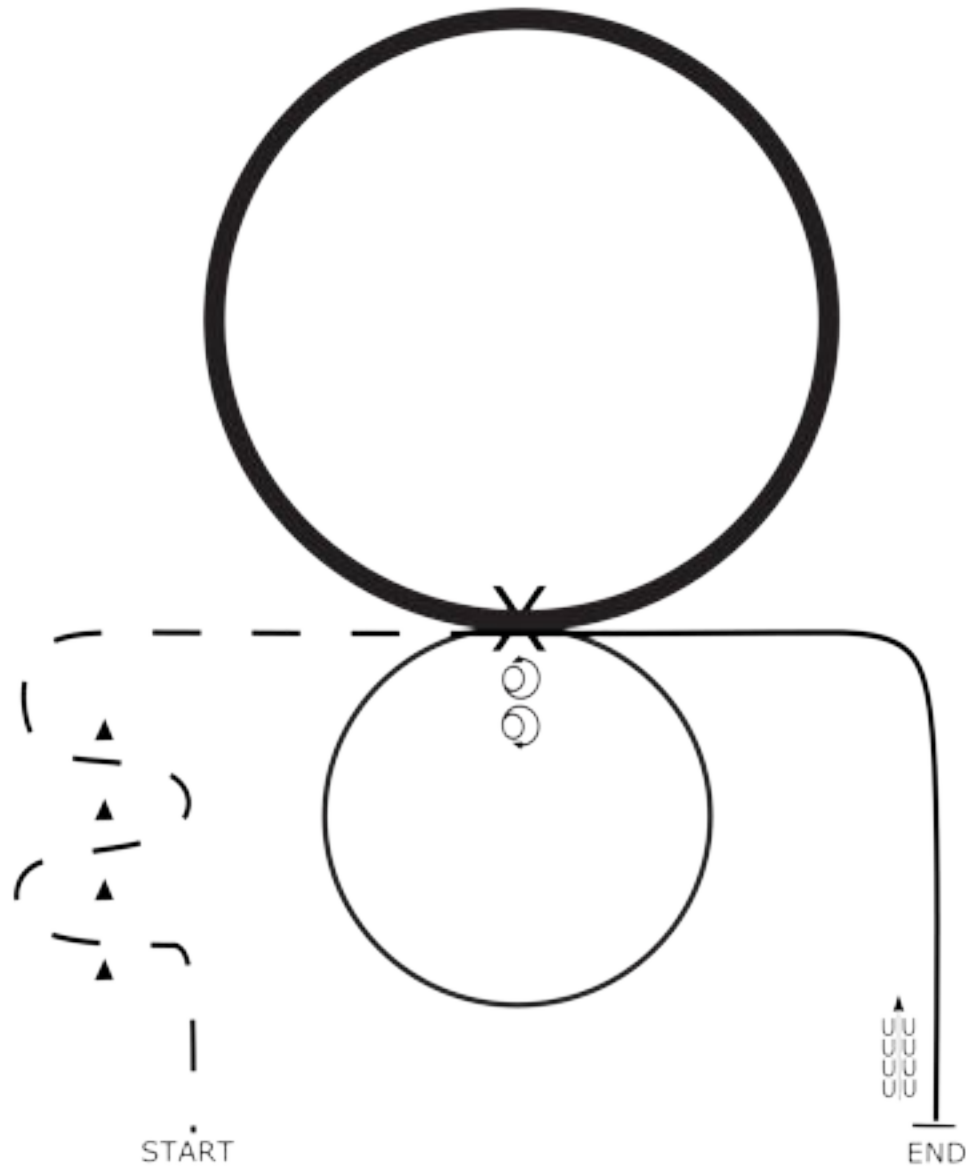

1. Trot through serpentine
2. Lope a large fast circle to the left on the left lead
3. Change leads
4. Lope a small slow circle to the right, stop
5. 2 spins left, 2 spins right
6. Lope on the right lead and turn right
7. Stop and back 5 steps.

Ranch Riding Pattern 5

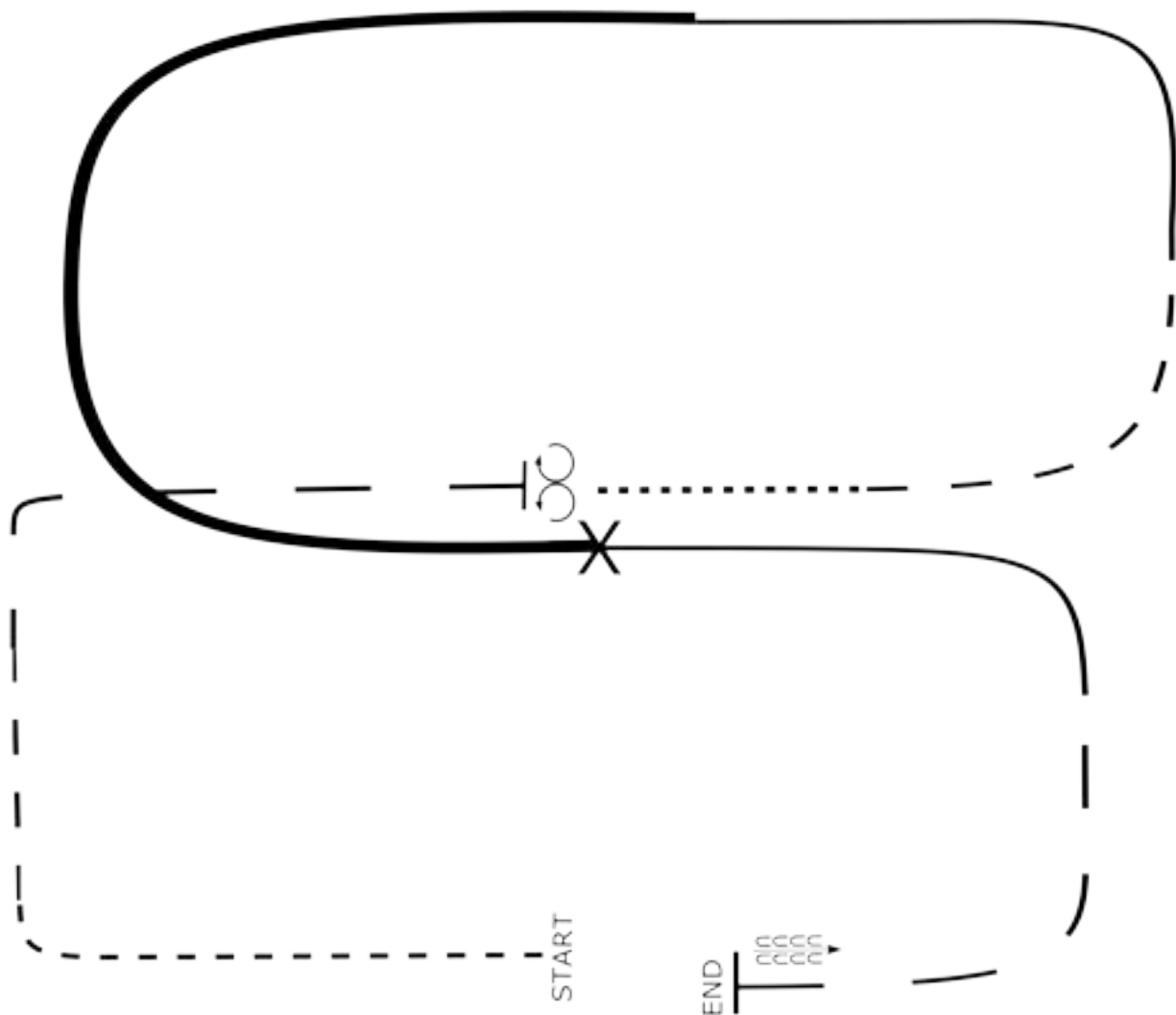

1. Walk to the left around corner of the arena
2. Trot
3. Extended Trot around the corner to center
4. Stop
5. 360 degree turn in each direction (either way first)
6. Walk
7. Trot left
8. Lope left lead
9. Extended lope to center
10. Change leads
11. Collect to normal lope
12. Extended trot
13. Stop and back.

Ranch Riding Pattern 6

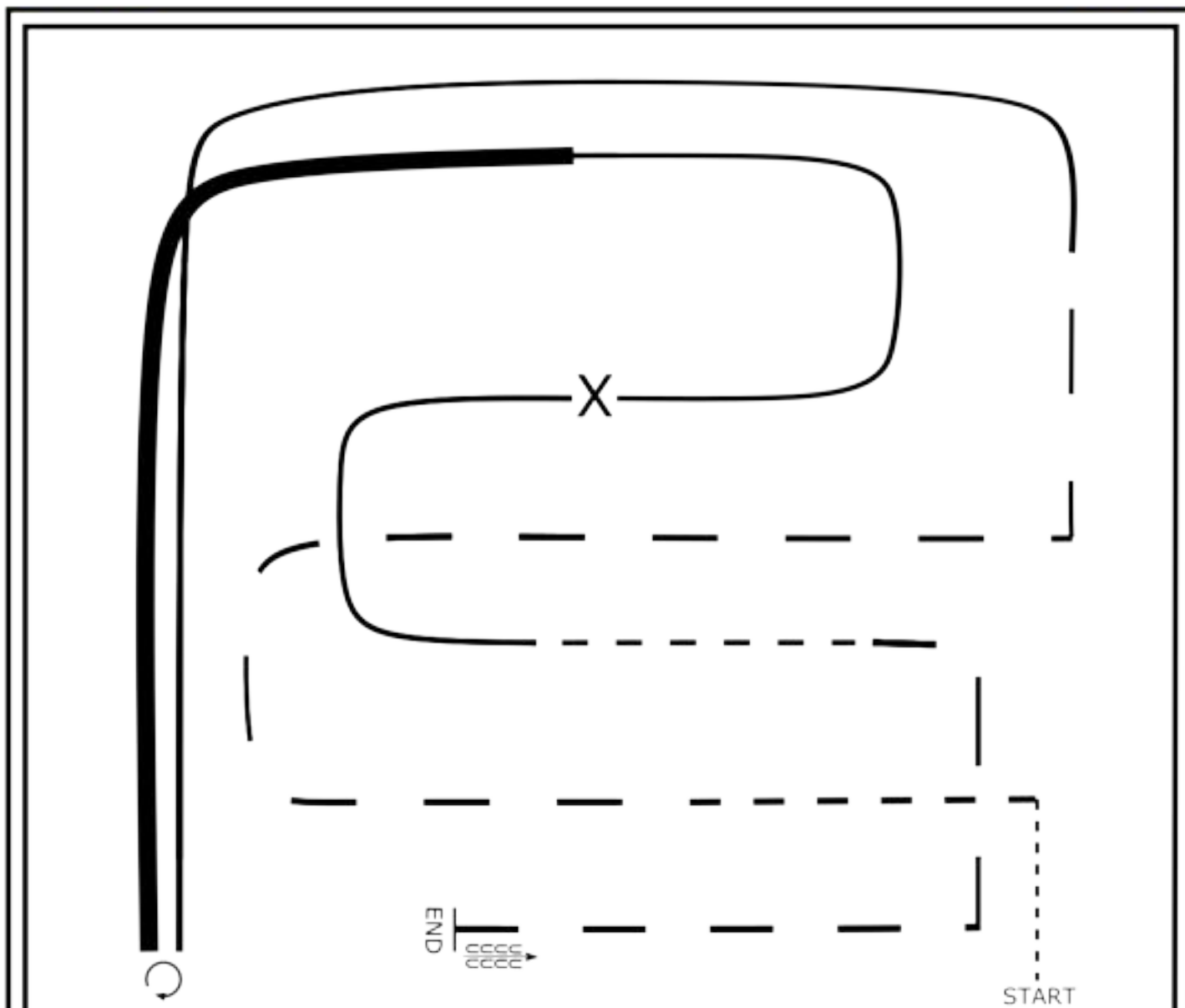

1. Walk
2. Trot
3. Extended Trot
4. Lope Left Lead
5. Stop, 1 1/2 turn right
6. Extended Lope Right Lead
7. Normal Lope
8. Change Leads
9. Trot
10. Extended Trot
11. Stop, Back

Ranch Riding Pattern 8

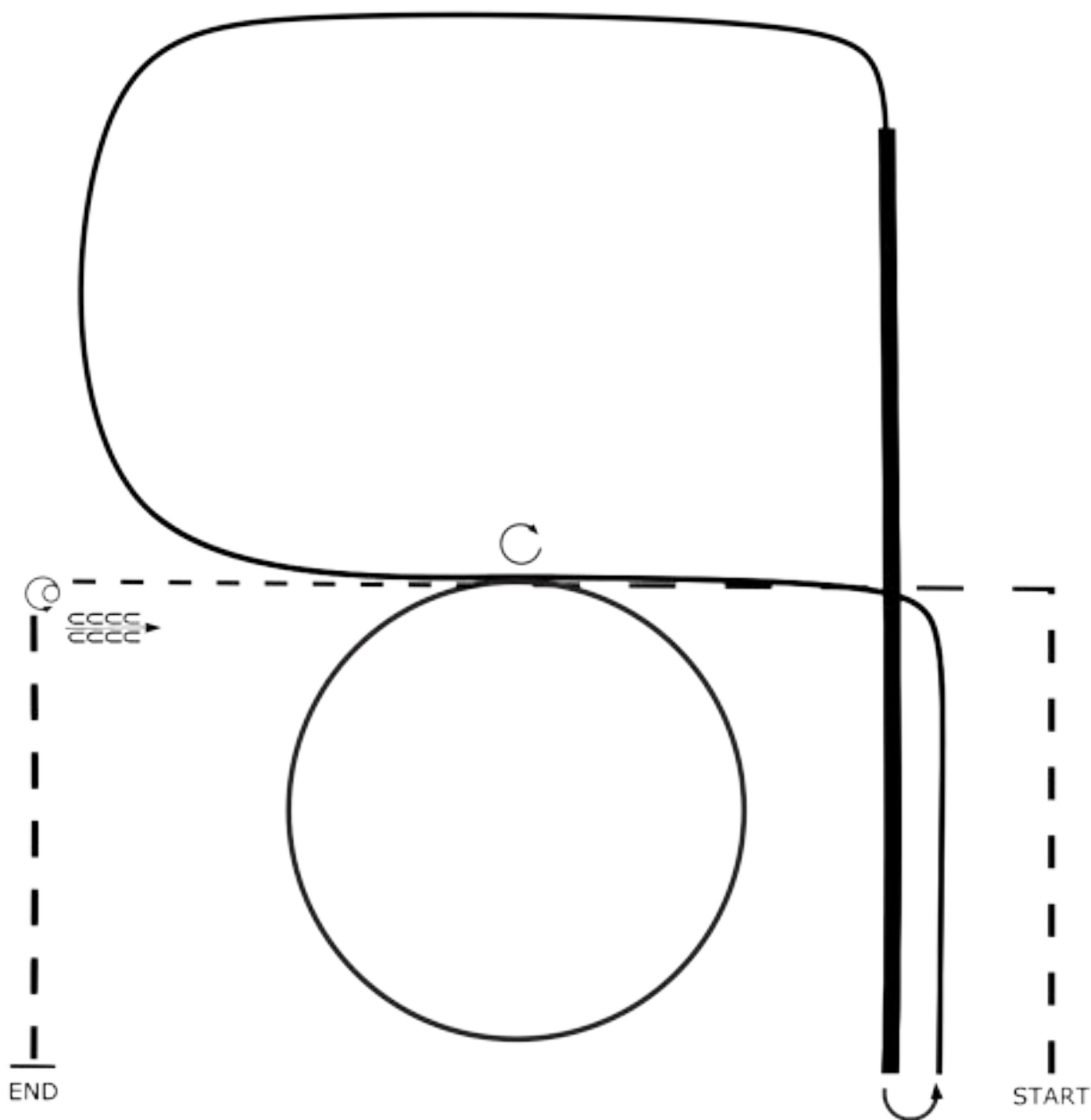

1. Trot to center and stop
2. One spin right
3. Right lead lope
4. Extend the lope
5. Stop, roll back left
6. Lope small circle to the left
7. Walk 10-15 steps
8. Stop, back 8 steps
9. 1 1/4 spins left
10. Trot, stop.

Ranch Riding Pattern 9

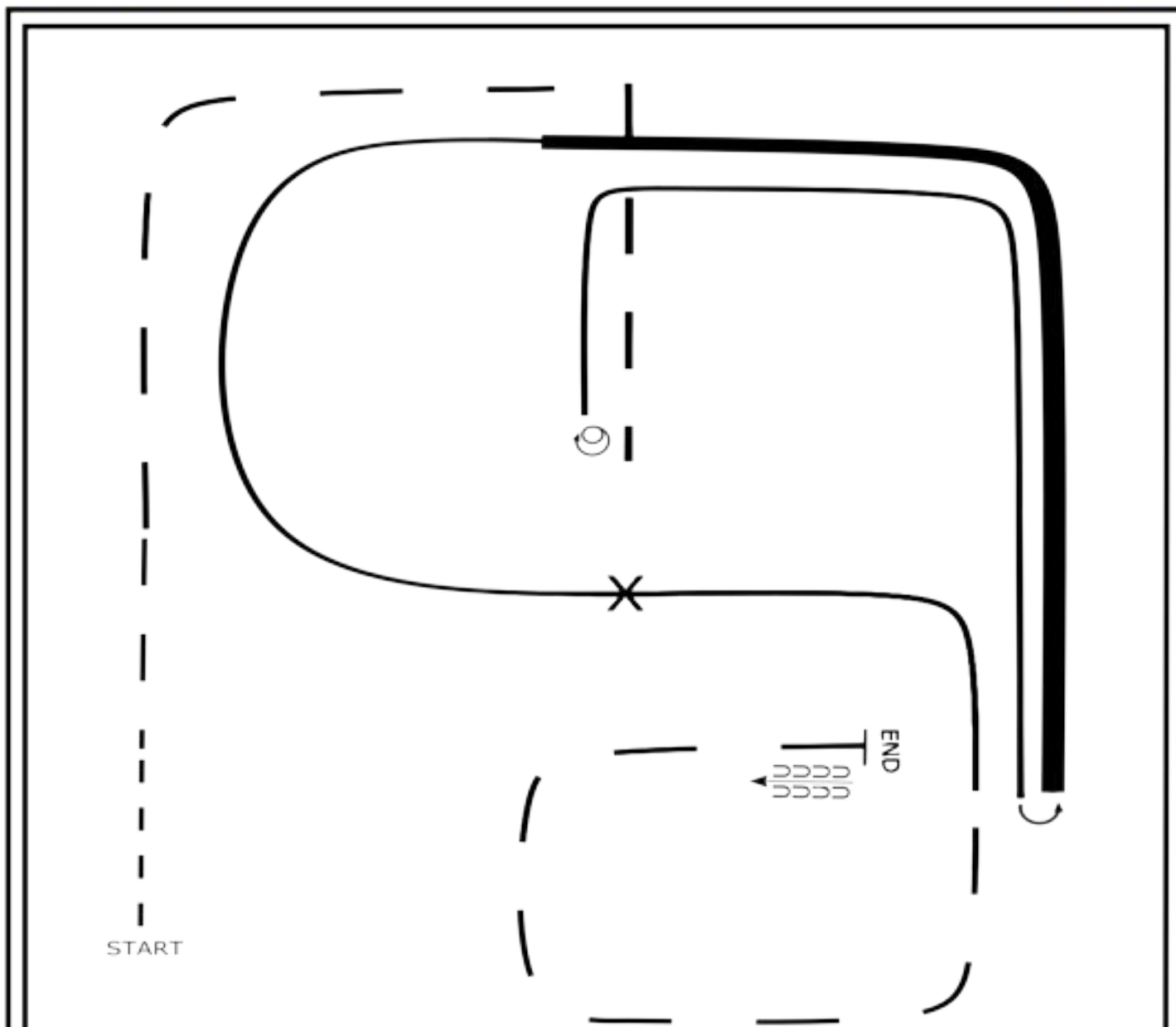

1. Walk
2. Trot
3. Extended Trot
4. Stop, 1 1/2 spins right
5. Lope on the right lead
6. Stop, Roll back Left
7. Extended Lope Left Lead
8. Normal Lope
9. Change Leads, continue on right lead
10. Extended Trot
11. Stop and back.

Ranch Riding Pattern 10

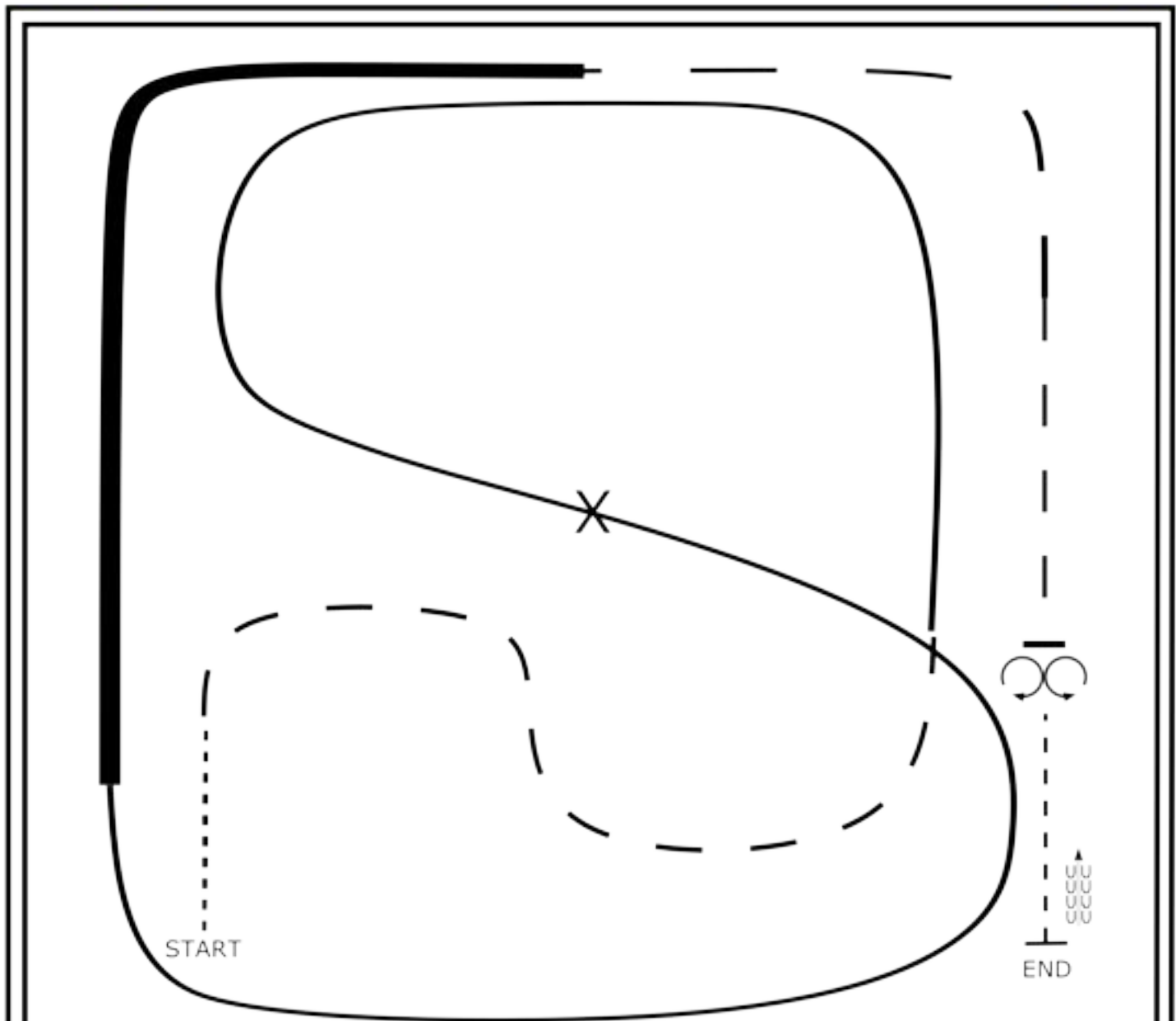

1. Walk
2. Jog
3. Lope left lead around end of arena, then diagonally across arena
4. Change leads
5. Extend the lope
6. Break to extended trot
7. Regular jog
8. Stop
9. Turn 360 each direction (either way first)
10. Walk
11. Stop and Back.

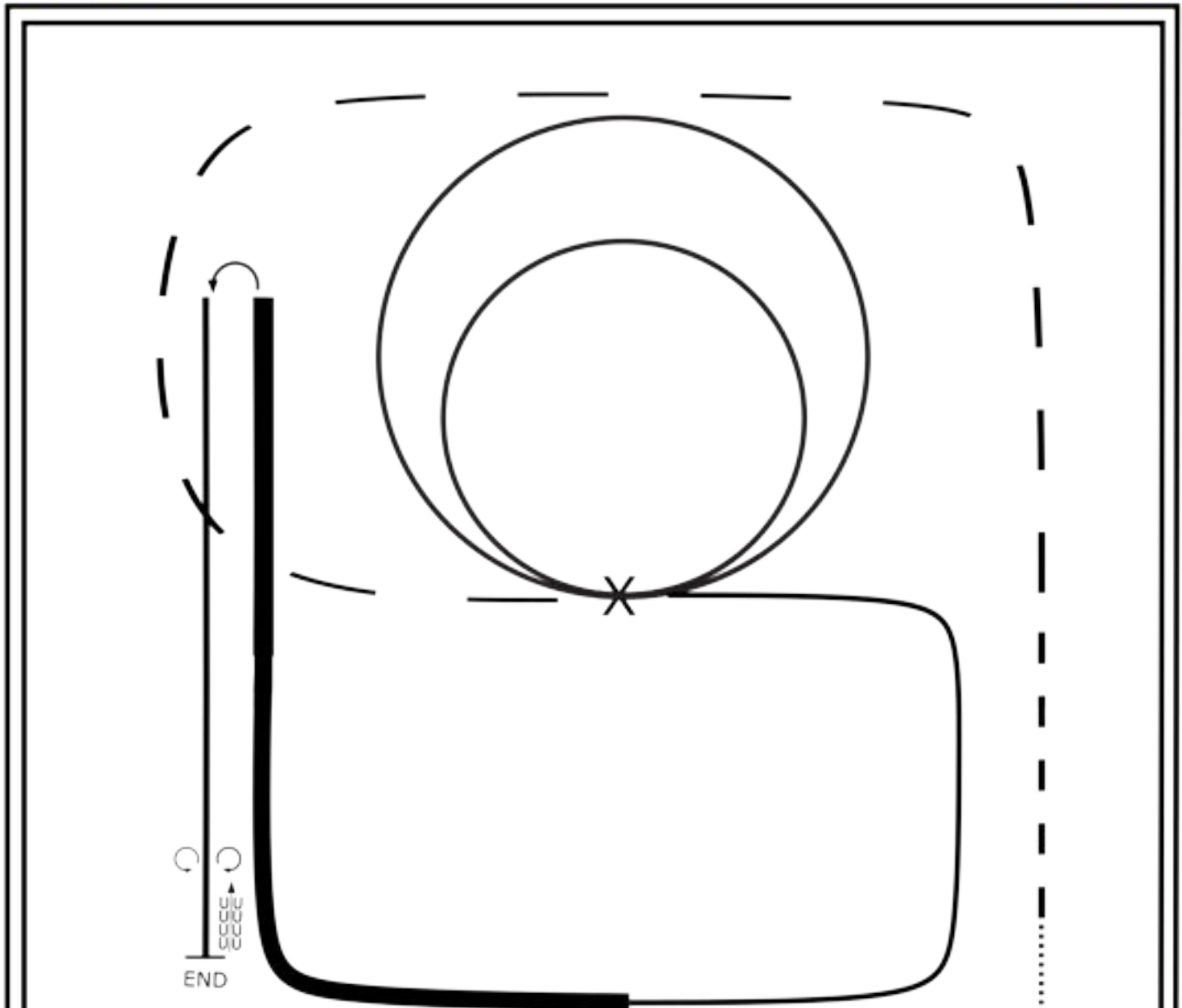

1. Walk
2. Trot
3. Extended Trot
4. Lope Left Lead Small Circle
5. Lope Left Lead Large Circle
6. Change Leads
7. Extended Lope
8. Stop, Roll Back Left
9. Lope Left Lead
10. Stop, Back
11. Turn 360* Each Direction
(Either direction first)

START

Ranch Riding Pattern 12

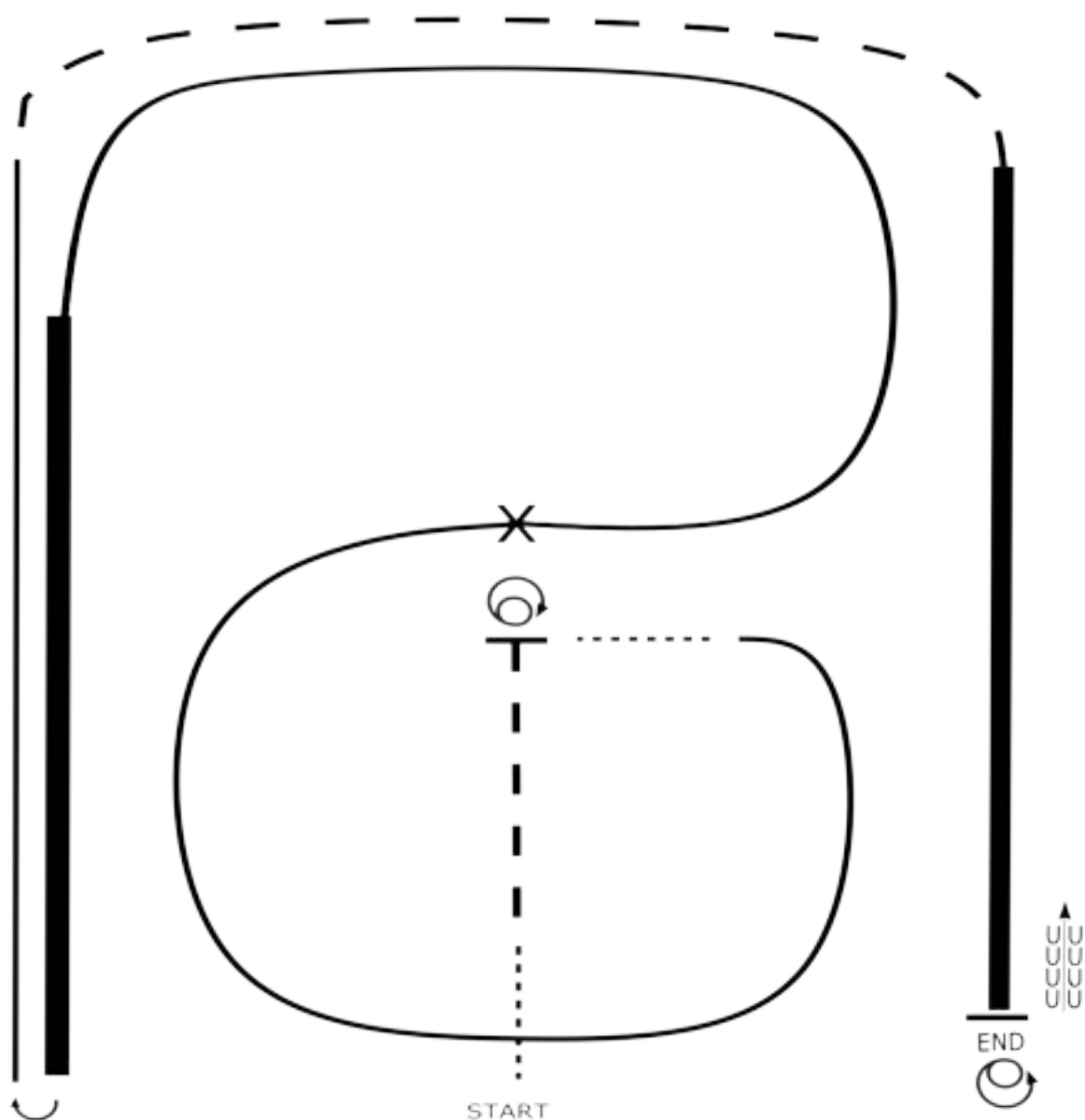

1. Walk
2. Trot
3. Stop, do a 1 1/4 turn to the right
4. Walk. Then lope a small circle on the right lead
5. Change leads, lope left lead around end of arena
6. Extend the lope on the left lead
7. Stop, roll back right
8. Lope straight on the right lead
9. Extend the jog around the end of the arena
10. Extend the lope on the right lead
11. Stop, do 2 turns left
12. Back.

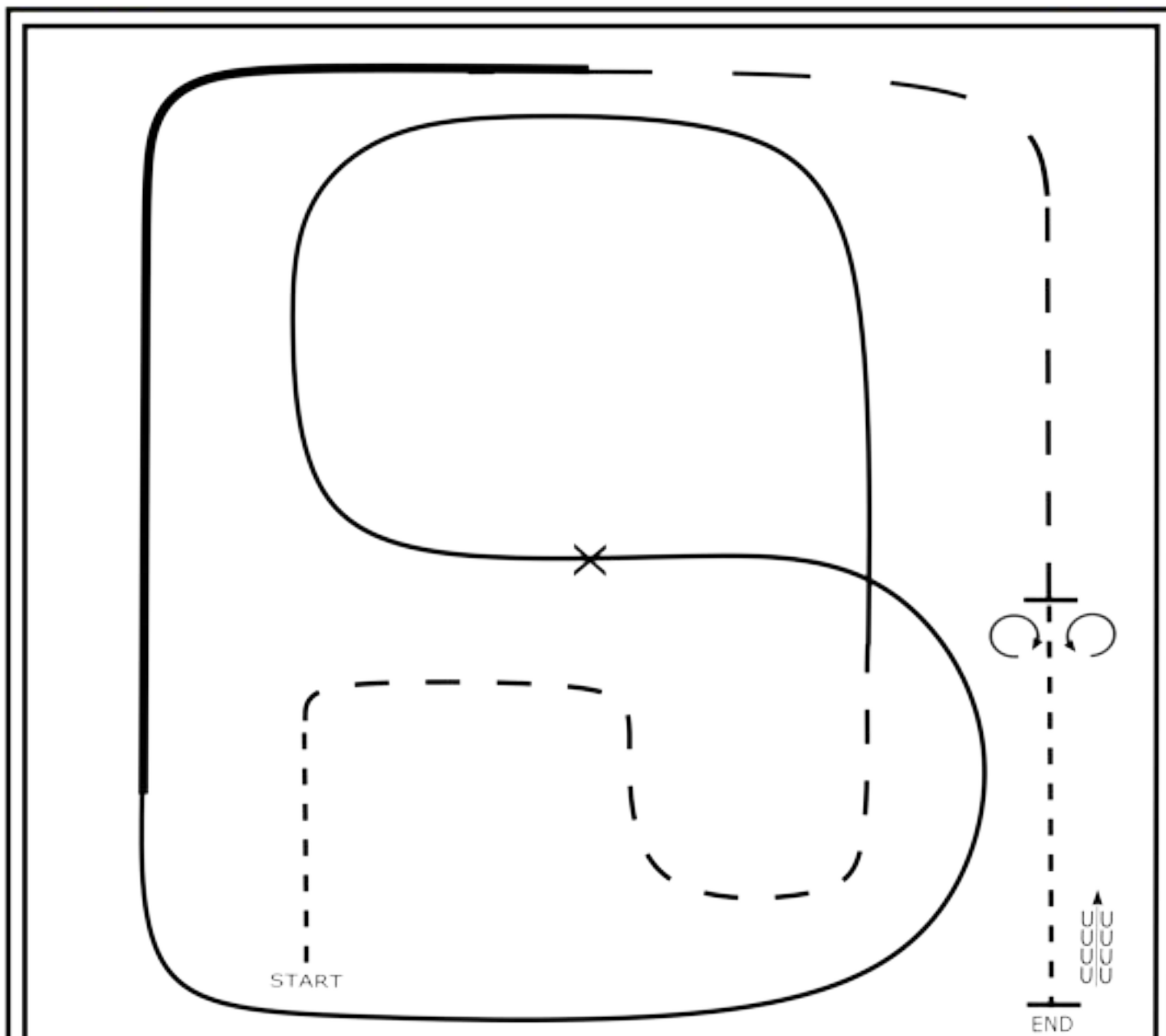

1. Walk
2. Trot serpentine
3. Lope left lead around end of arena and then diagonally across arena
4. Change leads
5. Lope on the right lead around end of arena
6. Extend lope on the straight away around corner to center of arena
7. Extend trot around corner of arena
8. Collect to a trot
9. Stop and do a 360 degree turn each direction (either direction first)
10. Walk, stop and back.

Ranch Riding Pattern 15

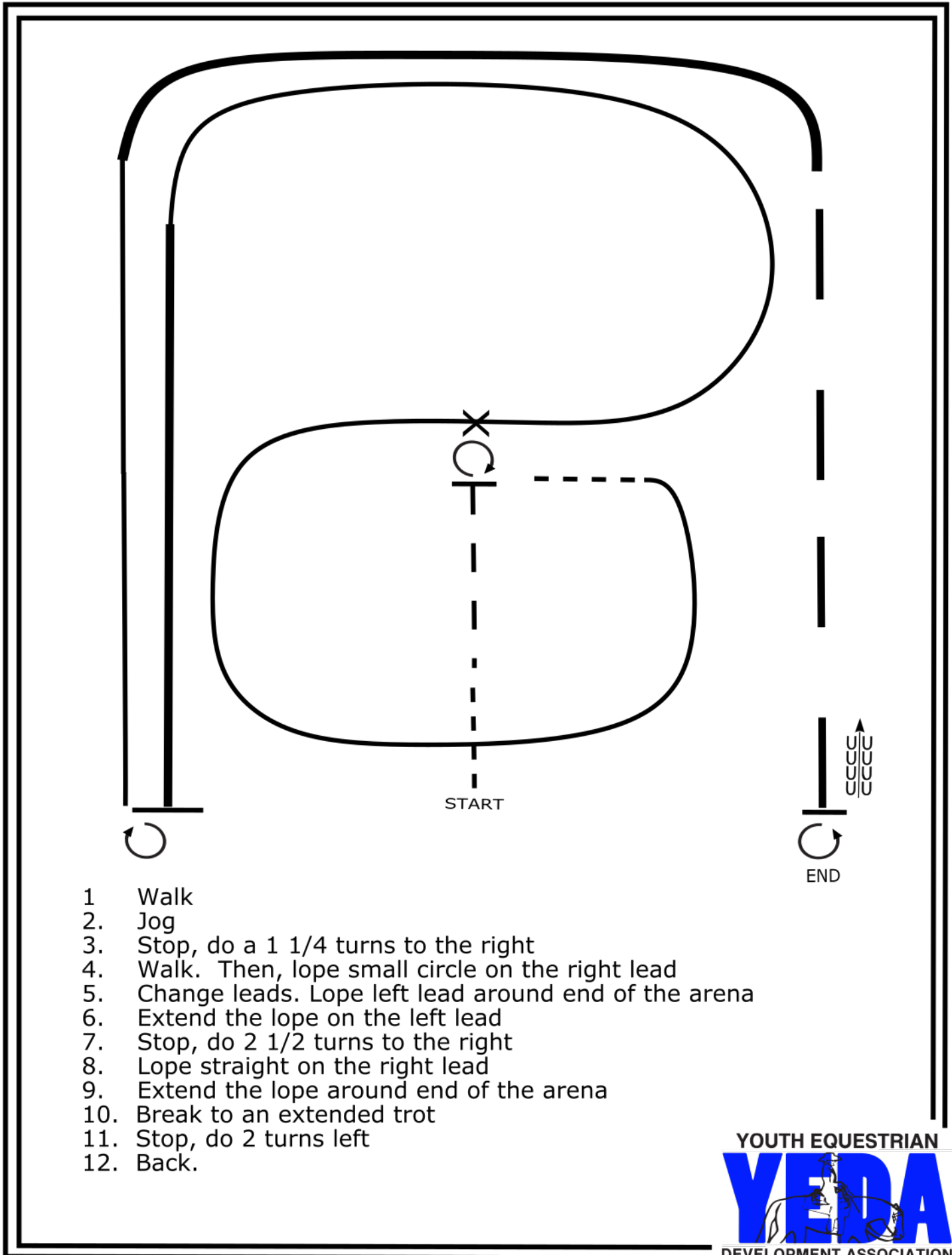

1. Walk
2. Jog
3. Stop, do a 1 1/4 turns to the right
4. Walk. Then, lope small circle on the right lead
5. Change leads. Lope left lead around end of the arena
6. Extend the lope on the left lead
7. Stop, do 2 1/2 turns to the right
8. Lope straight on the right lead
9. Extend the lope around end of the arena
10. Break to an extended trot
11. Stop, do 2 turns left
12. Back.

Ranch Riding Pattern 16

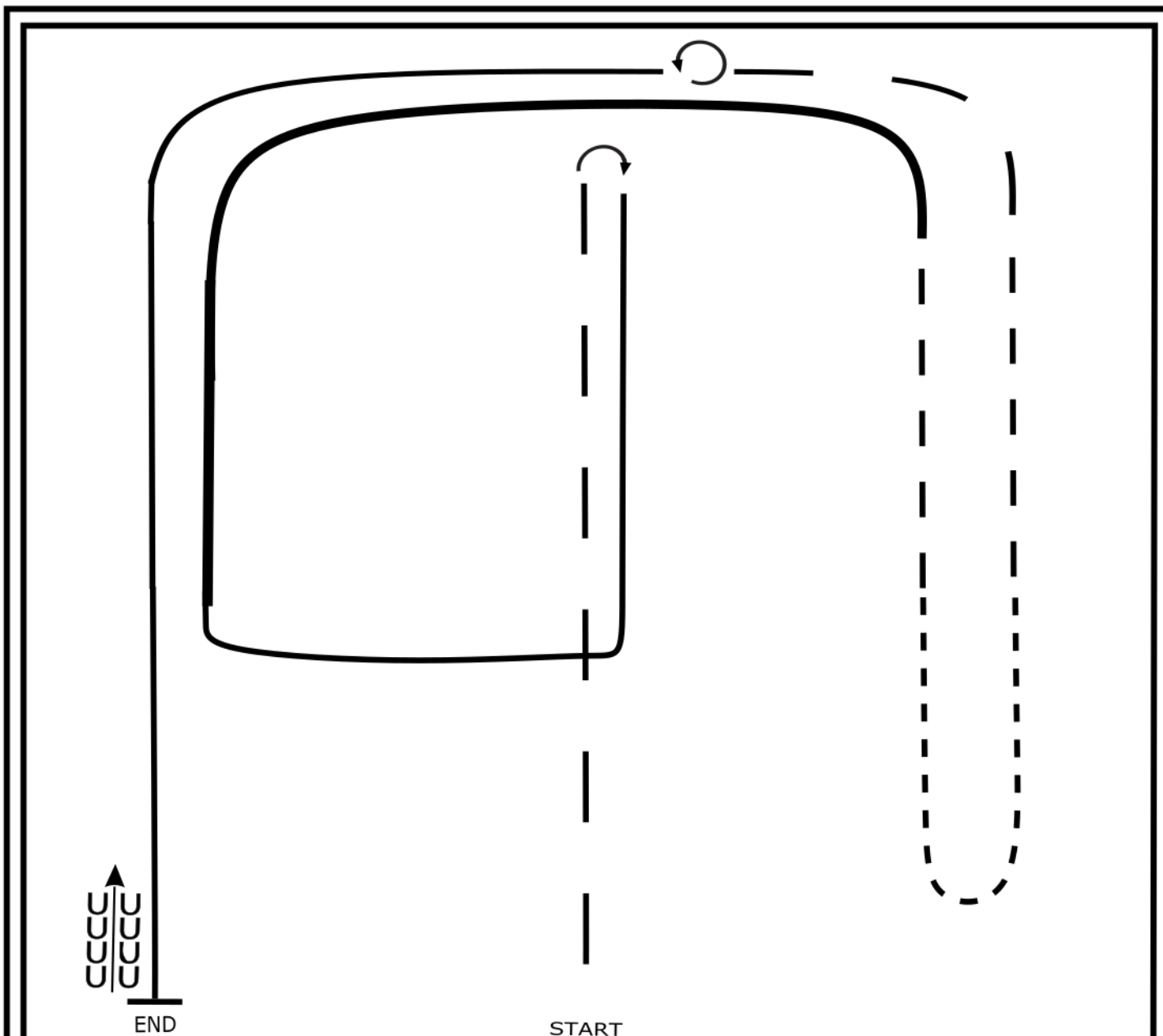

1. Extended trot
2. Stop, rollback right
3. Lope right lead
4. Extended lope (right lead)
5. Trot
6. Walk
7. Trot
8. Extended trot
9. Stop, 360 left
10. Lope left lead
11. Stop and back.

Ranch Riding Pattern A

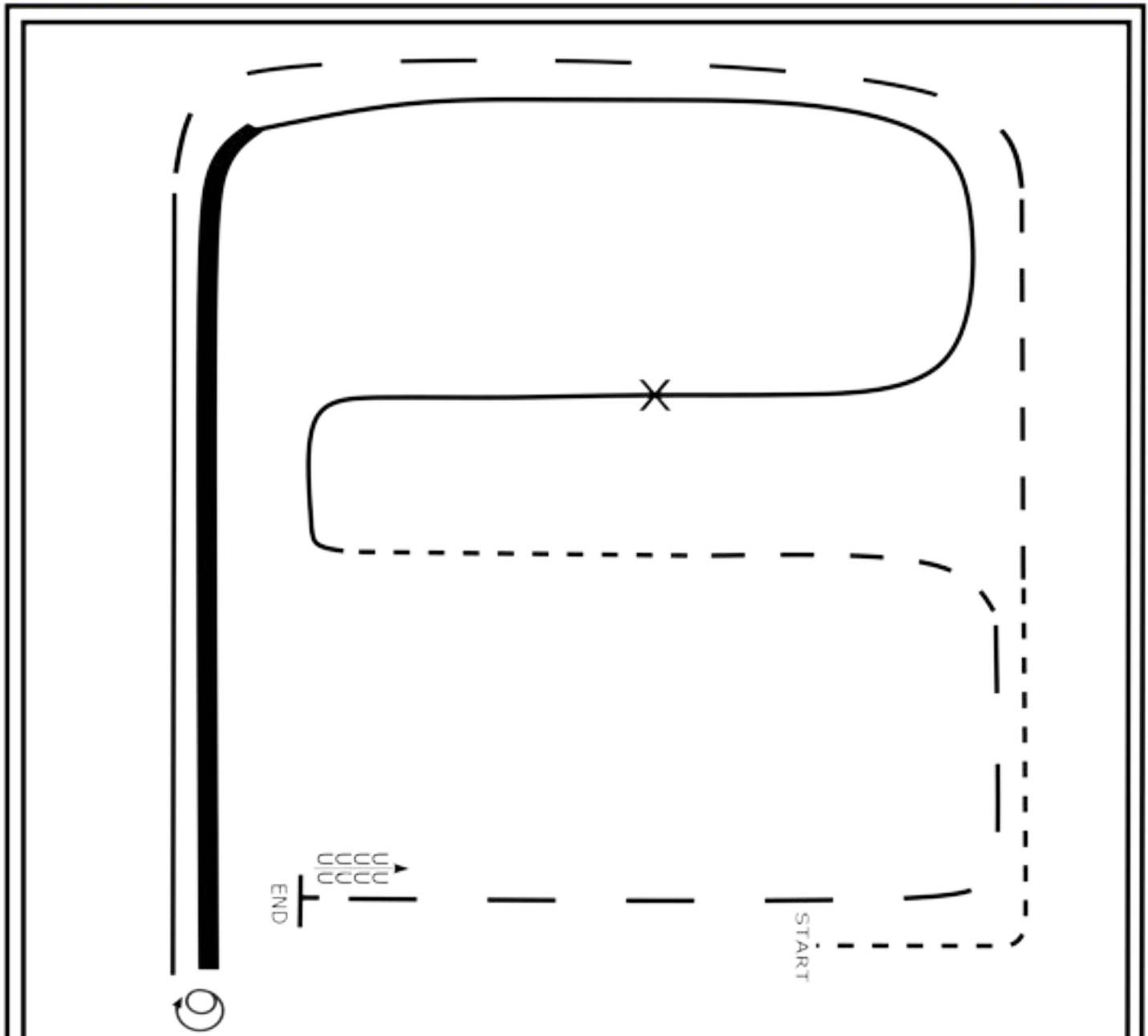

1. Walk
2. Trot
3. Extended trot
4. Left lead lope
5. Stop, 1 1/2 turn right
6. Extended lope
7. Collect to working lope- right lead
8. Change leads
9. Walk
10. Trot
11. Extended trot
12. Stop and back.

NRHA Pattern 1

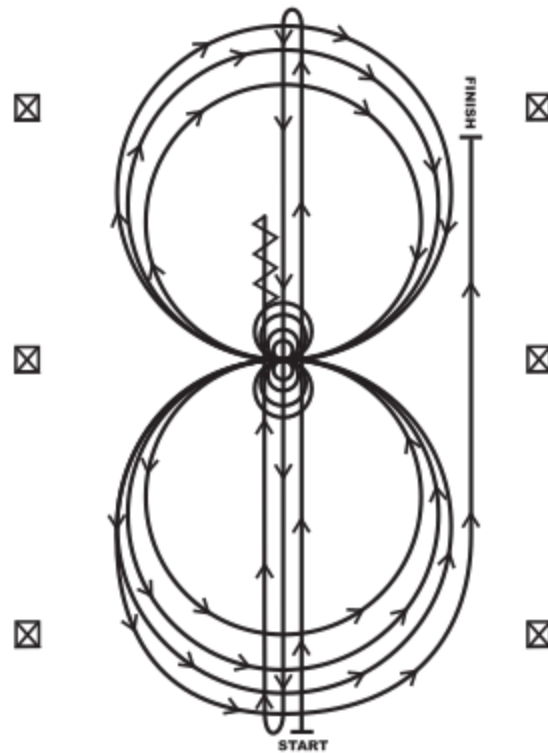

- 1.Run at speed to the far end of the arena past the end marker and do a left rollback—no hesitation.
- 2.Run to the opposite end of the arena past the end marker and do a right rollback—no hesitation.
- 3.Run past the center marker and do a sliding stop. Back up to center of the arena or at least ten feet (three meters). Hesitate.
- 4.Complete four spins to the right. Hesitate.
- 5.Complete four and one-quarter spins to the left so that horse is facing left wall or fence. Hesitate.
- 6.Beginning on the left lead, complete three circles to the left: the first circle large and fast; the second circle small and slow; the third circle large and fast. Change leads at the center of the arena.
- 7.Complete three circles to the right: the first circle large and fast; the second circle small and slow; the third circle large and fast. Change leads at the center of the arena.
- 8.Begin a large circle to the left but do not close this circle. Run straight up the right side of the arena past the center marker and do a sliding stop at least twenty feet (six meters) from wall or fence. Hesitate to demonstrate the completion of the pattern.

NRHA Pattern 2

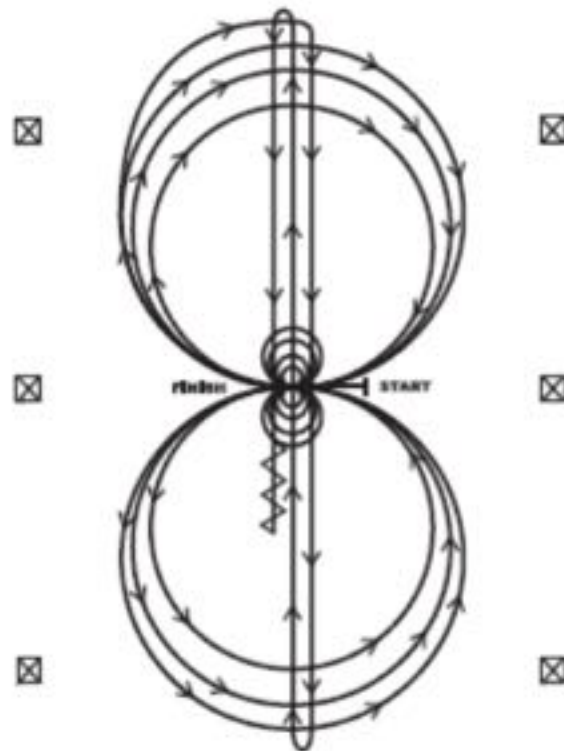

Horses may walk or jog to the center of arena. Horses must walk or stop prior to starting pattern. Beginning at the center of the arena facing the left wall or fence.

1. Beginning on the right lead, complete three circles to the right: the first circle small and slow; the next two circles large and fast. Change leads at the center of the arena.
2. Complete three circles to the left: the first circle small and slow; the next two circles large and fast. Change leads at the center of the arena.
3. Continue around previous circle to the right. At the top of the circle, run down the middle to the far end of the arena past the end marker and do a right rollback—no hesitation.
4. Run up the middle to the opposite end of the arena past the end marker and do a left rollback—no hesitation.
5. Run past the center marker and do a sliding stop. Backup to the center of the arena or at least ten feet (threemeters). Hesitate.
6. Complete four spins to the right. Hesitate.
7. Complete four spins to the left. Hesitate to demonstrate the completion of the pattern.

NRHA Pattern 3

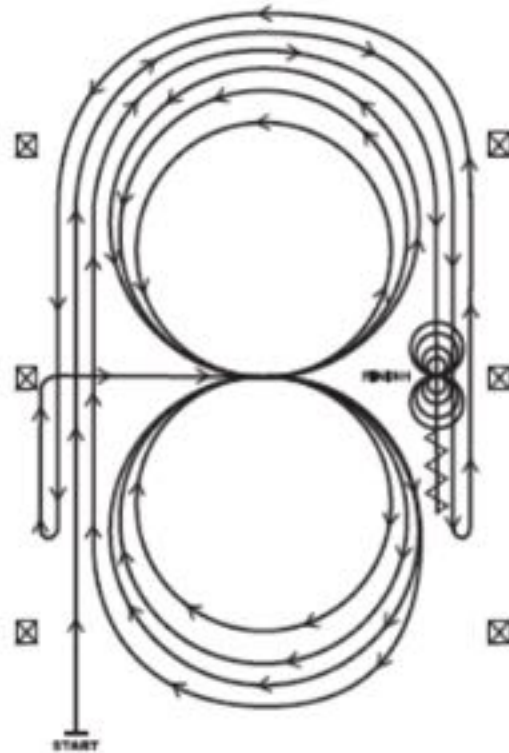

1. Beginning, lope straight up the left side of the arena, circle the top end of the arena, and staying at least twenty feet (six meters) from the walls or fence, run straight down the opposite or right side of the arena past the center marker and do a left rollback—no hesitation.
2. Continue straight up the right side of the arena circle back around the top of the arena, and staying at least twenty feet (six meters) from the walls or fence, run straight down the left side of the arena past the center marker and do a right rollback—no hesitation.
3. Continue up the left side of the arena to the center marker. At the center marker, the horse should be on the right lead. Guide the horse to the center of the arena on the right lead and complete three circles to the right: the first two circles large and fast; the third circle small and slow. Change leads at the center of the arena.
4. Complete three circles to the left: the first two circles large and fast; the third circle small and slow. Change leads in the center of the arena.
5. Begin a large circle to the right but do not close this circle. Continue up the left side of the arena, circle the top of the arena, and staying at least twenty feet (six meters) from the walls or fence, run straight down the opposite or right side of the arena past the center marker and do a sliding stop. Back up at least ten feet (three meters). Hesitate.
6. Complete four spins to the right. Hesitate.
7. Complete four spins to the left. Hesitate to demonstrate completion of the pattern.

NRHA Pattern 4

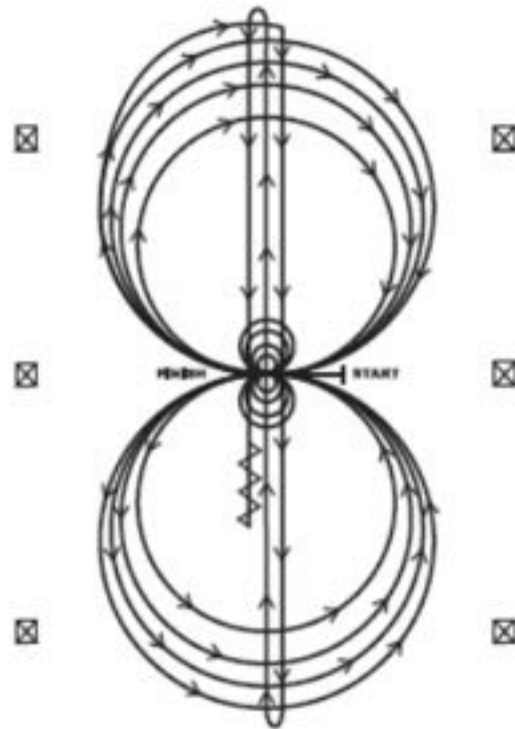

Horses may walk or jog to the center of the arena. Horses must walk or stop prior to starting pattern. Beginning at the center of the arena facing the left wall or fence.

1. Beginning on the right lead, complete three circles to the right: the first two large and fast; the third circle small and slow. Stop at the center of the arena. Hesitate.
2. Complete four spins to the right. Hesitate.
3. Beginning on the left lead, complete three circles to the left: the first two circles large and fast; the third circle small and slow. Stop at the center of the arena. Hesitate.
4. Complete four spins to the left. Hesitate.
5. Beginning on the right lead, run a large fast circle to the right, change leads at the center of the arena, run large fast circle to the left, and change leads at the center of the arena. (Figure 8)
6. Continue around previous circle to the right. At the top of the circle, run down the middle to the far end of the arena past the end marker and do a right rollback—no hesitation.
7. Run up the middle to the opposite end of the arena past the end marker and do a left rollback—no hesitation.
8. Run past the center marker and do a sliding stop. Backup to the center of the arena or at least ten feet (three meters). Hesitate to demonstrate completion of the pattern.

NRHA Pattern 5

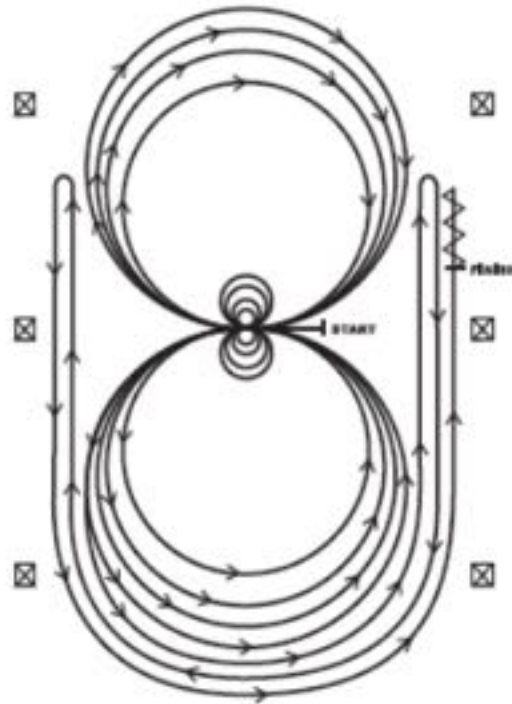

Horses may walk or jog to the **center of arena**. Horses must walk or stop prior to starting pattern. Beginning at the center of the arena facing **the left wall or fence**.

1. Beginning on the left lead, **complete three circles to the left: the first two circles large and fast; the third circle small and slow**. Stop at the **center of the arena. Hesitate**.
2. Complete four spins to the **left. Hesitate**.
3. Beginning on the right lead, **complete three circles to the right: the first two circles large and fast; the third circle small and slow**. Stop at **the center of the arena. Hesitate**.
4. Complete four spins to the **right. Hesitate**.
5. Beginning on the left lead, **run a large fast circle to the left, change leads at the center of the arena, run large fast circle to the right, and change leads at the center of the arena**. (Figure 8)
6. Continue around previous circle to the left but do not close this circle. Run up the right side of the arena past the center marker and do a right rollback at least twenty feet (six meters) from the wall or fence—no hesitation.
7. Continue around previous circle but do not close this circle. Run up the left side of the arena past the center marker and do a left rollback at least twenty feet (six meters) from the wall or fence—no hesitation.
8. Continue back around previous circle but do not close this circle. Run up the right side of the arena past the center marker and do a sliding stop at least twenty feet (six meters) from the wall or fence. Back up at least ten feet (three meters). Hesitate to demonstrate completion of the pattern.

NRHA Pattern 6

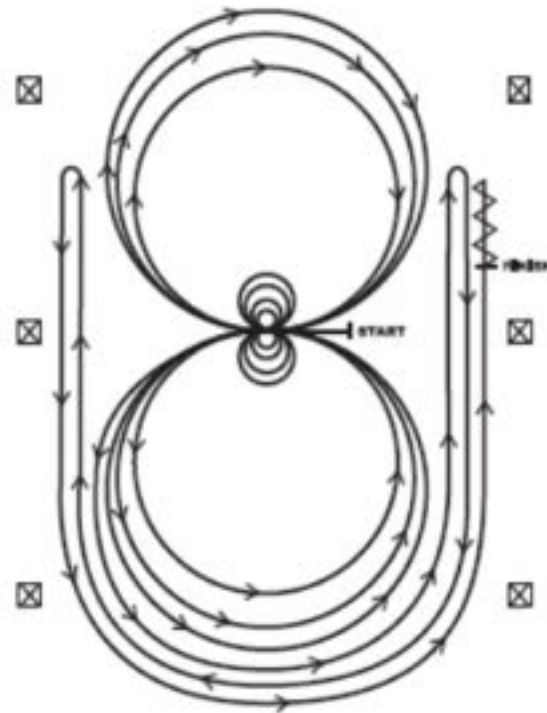

Horses may walk or jog to **the center of arena**. Horses must walk or stop prior to starting pattern. Beginning at the center of the arena facing the left wall or fence.

1. Complete four spins to the **right**. Hesitate.
2. Complete four spins to the **left**. Hesitate.
3. Beginning on the left lead, **complete three circles to the left: the first two circles large and fast; the third circle small and slow**. Change leads at the center of the arena.
4. Complete three circles to **the right: the first two circles large and fast; the third circle small and slow**. Change leads at the center of the arena.
5. Begin a large circle to the **left but do not close this circle**. Run up the **right side** of the arena past the center marker and do a **right rollback at least twenty feet (six meters) from the wall or fence**—no hesitation.
6. Continue back around previous circle but do not close this circle. Run up the **left side** of the arena past the center marker and do a **left rollback at least twenty feet (six meters) from the wall or fence**—no hesitation.
7. Continue back around previous circle but do not close this circle. Run up the **right side** of the arena past the center marker and do a **sliding stop at least twenty feet (six meters) from the wall or fence**. Back up at least ten feet (three meters). Hesitate to demonstrate the completion of the pattern.

NRHA Pattern 7

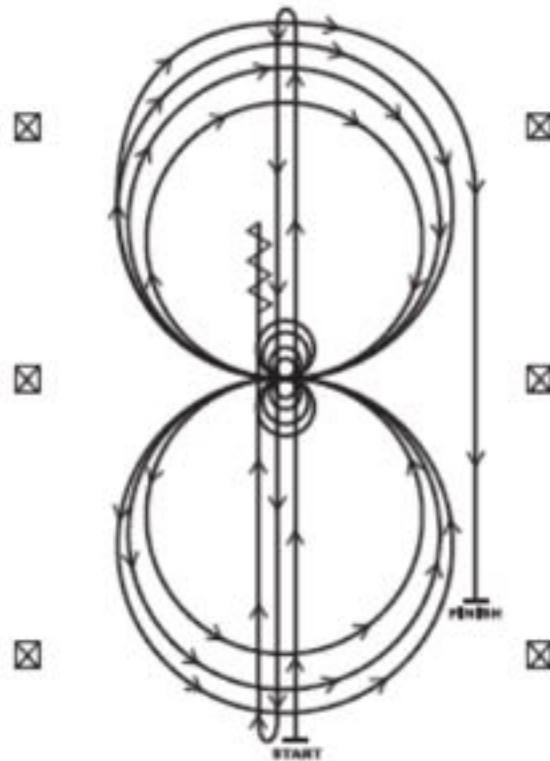

1. Run at speed to the far end of the arena past the end marker and do a left rollback—no hesitation.
2. Run to the opposite end of the arena past the end marker and do a right rollback—no hesitation.
3. Run past the center marker and do a sliding stop. Backup to the center of the arena or at least ten feet (three meters). Hesitate.
4. Complete four spins to the right. Hesitate.
5. Complete four and one-quarter spins to the left so that horse is facing left wall or fence. Hesitate.
6. Beginning on the right lead, complete three circles to the right: the first two circles large fast; the third circle small and slow. Change leads at the center of the arena.
7. Complete three circles to the left: the first two circles large fast; the third circle small and slow. Change leads at the center of the arena.
8. Begin a large circle to the right but do not close this circle. Run straight down the right side of the arena past the center marker and do a sliding stop at least twenty feet (six meters) from the wall or fence. Hesitate to demonstrate completion of the pattern.

NRHA Pattern 8

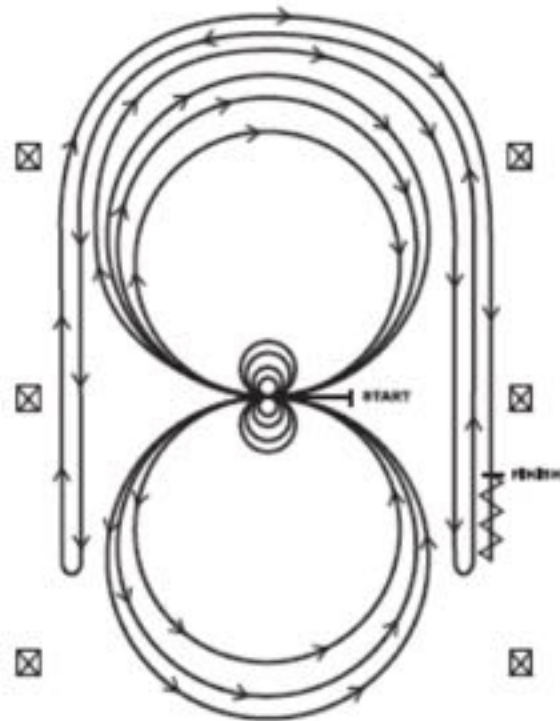

Horses may walk or jog to the center of arena. Horses must walk or stop prior to starting pattern. Beginning at the center of arena facing the left wall or fence.

1. Complete four spins to the left. Hesitate.
2. Complete four spins to the right. Hesitate.
3. Beginning on the right lead, complete three circles to the right: the first circle large and fast; the second circle small and slow; the third circle large and fast. Change leads at the center of the arena.
4. Complete three circles to the left: the first circle large and fast; the second circle small and slow; the third circle large and fast. Change leads at the center of the arena.
5. Begin a large circle to the right but do not close this circle. Run straight down the right side of the arena past the center marker and do a left rollback at least twenty feet (six meters) from the wall or fence—no hesitation.
6. Continue back around the previous circle but do not close this circle. Run down the left side of the arena past the center marker and do a right rollback at least twenty feet (six meters) from the wall or fence—no hesitation.
7. Continue back around the previous circle but do not close this circle. Run down the right side of the arena past the center marker and do a sliding stop at least twenty feet (six meters) from the wall or fence. Back up at least ten feet (three meters). Hesitate to demonstrate completion of the pattern.

NRHA Pattern 9

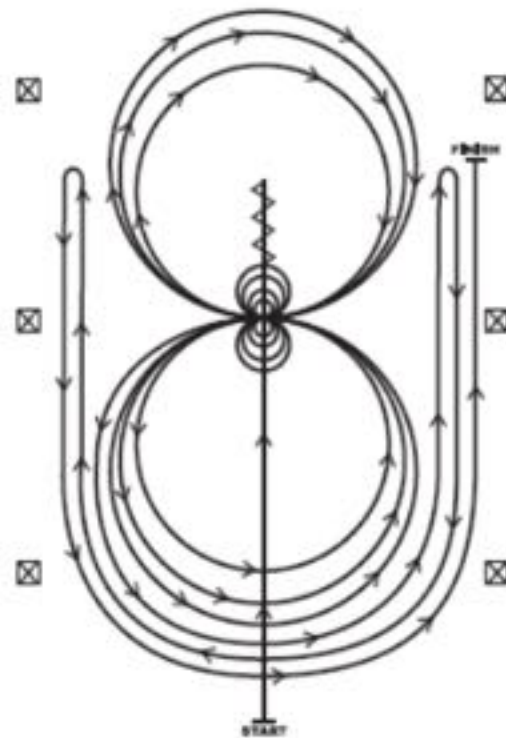

1. Run past the center marker and do a sliding stop. Backup to the center of the arena or at least ten feet (three meters). Hesitate.
2. Complete four spins to the right. Hesitate.
3. Complete four and one-quarter spins to the left so that horse is facing the left wall or fence. Hesitate.
4. Beginning on the left lead, complete three circles to the left: the first circle small and slow; the next two circles large and fast. Change leads at the center of the arena.
5. Complete three circles to the right: the first circle small and slow; the next two circles large and fast. Change leads at the center of the arena.
6. Begin a large circle to the left but do not close this circle. Run up the right side of the arena past the center marker and do a right rollback at least twenty feet (six meters) from the wall or fence—no hesitation.
7. Continue back around the previous circle but do not close this circle. Run up the left side of the arena past the center marker and do a left rollback at least twenty feet (six meters) from the wall or fence—no hesitation.
8. Continue back around previous circle but do not close this circle. Run up right side of the arena past the center marker and do a sliding stop at least twenty feet (six meters) from the wall or fence. Hesitate to demonstrate completion of the pattern.

NRHA Pattern 10

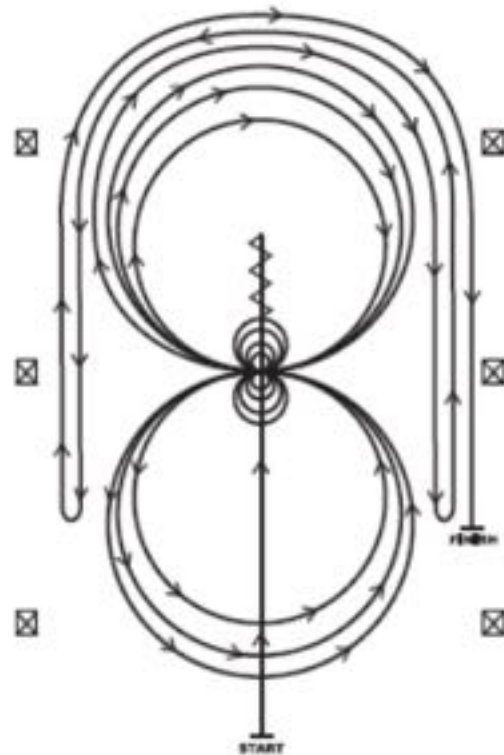

1. Run past the center marker and do a sliding stop. Backup to the center of the arena or at least ten feet (three meters). Hesitate.
2. Complete four spins to the right. Hesitate.
3. Complete four and one-quarter spins to the left so that the horse is facing the left wall or fence. Hesitate.
4. Beginning on the right lead, complete three circles to the right: the first two circles large and fast, the third circle small and slow. Change leads at the center of the arena.
5. Complete three circles to the left: the first circle small and slow, the next two circles large and fast. Change leads at the center of the arena.
6. Begin a large circle to the right but do not close this circle. Run down the right side of the arena past the center marker and do a left rollback at least twenty feet (six meters) from the wall or fence—no hesitation.
7. Continue back around the previous circle but do not close this circle. Run down the left side of the arena past the center and do a right rollback at least twenty feet (six meters) from the wall or fence—no hesitation.
8. Continue back around previous circle but do not close this circle. Run down the right side of the arena past the center marker and do a sliding stop at least twenty feet (six meters) from the wall or fence. Hesitate to demonstrate completion of the pattern.

NRHA Pattern 11

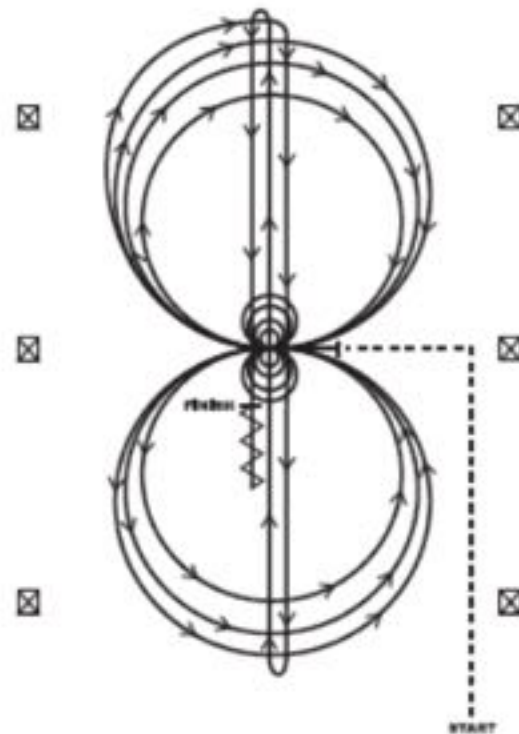

Horses must jog to the center of the arena (see Judges Guide for maneuver description). Horses must walk or stop prior to starting the pattern. Beginning at the center of the arena facing the left wall or fence.

1. Complete four spins to the left. Hesitate.
2. Complete four spins to the right. Hesitate.
3. Beginning on the right led complete three circles to the right; the first circle small and slow; the next two circles large and fast. Change leads at the center of the arena.
4. Complete three circles to the left; the first circle small and slow; the next two circles large and fast. Change leads at the center of the arena.
5. Begin a large circle to the right, but do not close this circle. Run down the center of the arena past the end marker and do a right rollback—no hesitation.
6. Run up the middle to the opposite end of the arena past the end marker and do a left rollback—no hesitation.
7. Run past the center marker and do a sliding stop. Back up to the center of the arena or at least ten feet (three meters). Hesitate to demonstrate completion of the pattern.

NRHA Pattern 12

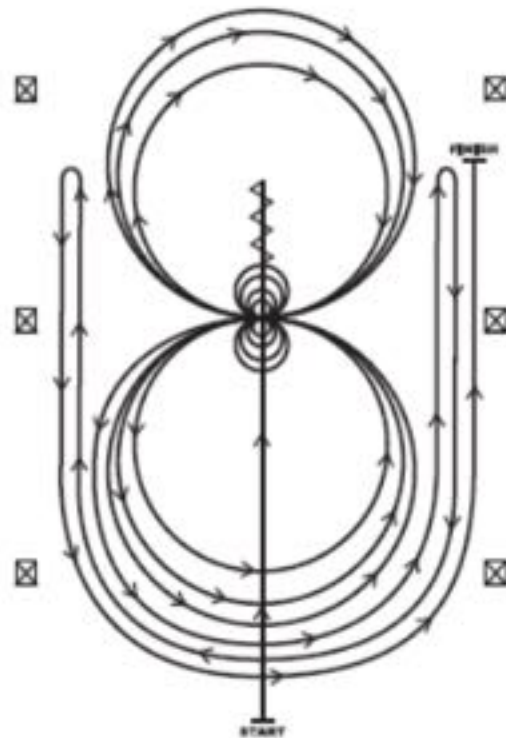

1. Run past the center marker **and do a sliding stop. Back up to the center of the arena** or at least 10 feet (3meters). Hesitate.
2. Complete four spins to the **right. Hesitate.**
3. Complete four and one-quarter spins to the **left so that the horse is facing the left wall or fence.** Hesitate.
4. Beginning on the left lead, **complete three circles to the left: the first two circles large and fast; the third circle small and slow. Change leads at the center of the arena.**
5. Complete three circles to the **right: the first two circles large and fast; the third circle small and slow. Change leads at the center for the arena.**
6. Begin a large circle to the left but do not close this circle. Run up the right side of the arena past the center marker and do a right rollback at least 20 feet (6 meters) from the wall or fence-no hesitation.
7. Continue back around previous circle but do not close this circle. Run up the left side of the arena and past the center marker and do a left rollback at least 20 feet (6meters) from the wall or fence-no hesitation.
8. Continue back around previous circle but do not close this circle. Run up the right side of the arena past the center marker and do a sliding stop at least 20 feet (6 meters) from the wall or fence. Hesitate to demonstrate completion of pattern.

NRHA Pattern 13

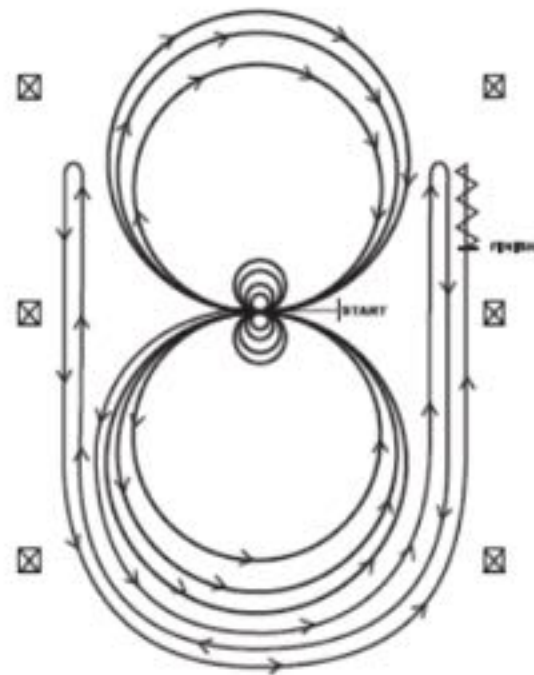

Horses must walk or stop prior to starting pattern. Beginning at the center of the arena facing the left wall or fence.

1. Beginning on the left lead, **complete two circles to the left: the first circle large and fast; the second circle small and slow. Stop at the center of the arena**
2. Complete four spins to the **left. Hesitate.**
3. Beginning on the right lead, **complete two circles to the right: the first being large and fast; the second circle small and slow. Stop at the center of the arena.**
4. Complete four spins to the **right. Hesitate.**
5. Beginning on the left lead, run **a large fast circle to the left, change leads at the center of the arena, run a large fast circle to the right, and change leads at the center of the arena.**
6. Continue around previous circle to the left but do not close this circle. Run up the right side of the arena past the center marker and do a right rollback at least 20 feet (6 meters) from the wall or fence-no hesitation.
7. Continue around previous circle but do not close this circle. Run up the left side of the arena past the center marker and do a left rollback at least 20 feet (6 meters) from the wall or fence-no hesitation.
8. Continue back around previous circle but do not close this circle. Run up the right side of the arena past the center marker and do a sliding stop at least 20 feet (6 meters) from the wall or fence. Back up at least 10 feet (3 meters). Hesitate to demonstrate completion of pattern.

NRHA Pattern 14

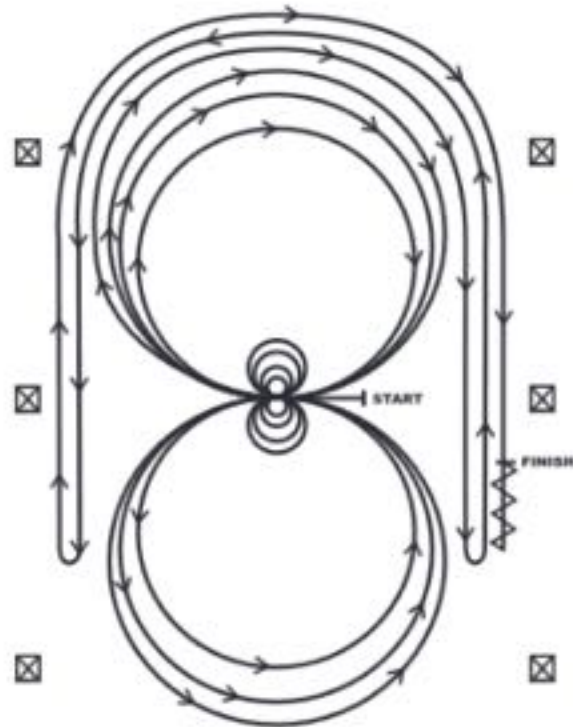

Horses may walk or jog to the center of arena. Horses must walk or stop prior to starting pattern. Beginning at the center of the arena facing the left wall or fence.

1. Complete four spins to the left. Hesitate.
2. Complete four spins to the right. Hesitate.
3. Beginning on the right lead, complete three circles to the right: the first two circles large and fast; the third circle small and slow. Change leads at the center of the arena.
4. Complete three circles **to the left**: the first two circles large and fast; the third circle small and slow. Change leads at the center of the arena.
5. Begin a large circle to the right but do not close this circle. Run up the right side of the arena past the center marker and do a left rollback at least twenty feet (six meters) from the wall or fence—no hesitation.
6. Continue back around previous circle but do not close This circle. Run up the left side of the arena past the center marker and do a right rollback at least twenty feet (six meters) from the wall or fence—no hesitation.
7. Continue back around previous circle but do not close this circle. Run up the right side of the arena past the center marker and do a sliding stop at least twenty feet (six meters) from the wall or fence. Back up at least ten feet (three meters). Hesitate to demonstrate the completion of pattern.

NRHA Pattern 15

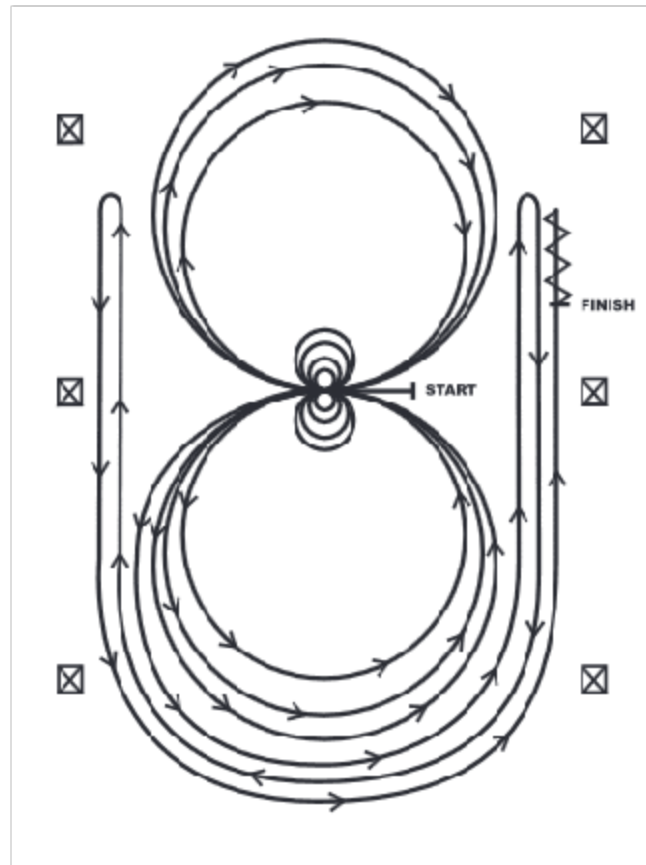

Horses may walk or jog to the center of arena. Horses must walk or stop prior to starting pattern. Beginning at the center of arena facing the left wall or fence.

1. Complete four spins to the right. Hesitate.
2. Complete four spins to the left. Hesitate.
3. Beginning on the left lead, complete three circles to the left: the first circle large and fast; the second circle small and slow; the third circle large and fast. Change leads at the center of the arena.
4. Complete three circles to the right: the first circle large and fast; the second circle small and slow; the third circle large and fast. Change leads at the center of the arena.
5. Begin a large circle to the left but do not close this circle. Run straight down the right side of the arena past the center marker and do a right rollback at least twenty feet (six meters) from the wall or fence—no hesitation.
6. Continue back around the previous circle but do not close this circle. Run down the left side of the arena past the center marker and do a left rollback at least twenty feet (six meters) from the wall or fence—no hesitation.
7. Continue back around the previous circle but do not close this circle. Run down the right side of the arena past the center marker and do a sliding stop at least twenty feet (six meters) from the wall or fence. Back up at least ten feet (three meters). Hesitate to demonstrate completion of the pattern.

NRHA Pattern 16

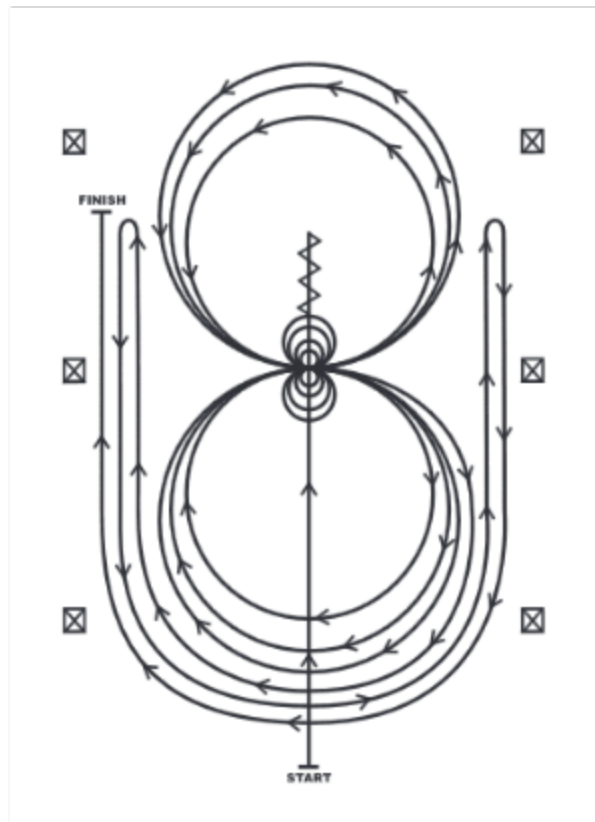

1. Run past the center marker and do a sliding stop. Back up to the center of the arena or at least 10 feet (3 meters). Hesitate.
2. Complete four spins to the left. Hesitate.
3. Complete four and one-quarter spins to the right so that the horse is facing the right wall or fence. Hesitate.
4. Beginning on the right lead, complete three circles to the right: the first two circles large and fast; the third circle small and slow. Change leads at the center of the arena.
5. Complete three circles to the left: the first two circles large and fast; the third circle small and slow. Change leads at the center for the arena.
6. Begin a large circle to the right but do not close this circle. Run up the left side of the arena past the center marker and do a left rollback at least 20 feet (6 meters) from the wall or fence-no hesitation.
7. Continue back around previous circle but do not close this circle. Run up the right side of the arena and past the center marker and do a right rollback at least 20 feet (6 meters) from the wall or fence-no hesitation.
8. Continue back around previous circle but do not close this circle. Run up the left side of the arena past the center marker and do a sliding stop at least 20 feet (6 meters) from the wall or fence. Hesitate to demonstrate completion of pattern.

NRHA Pattern A

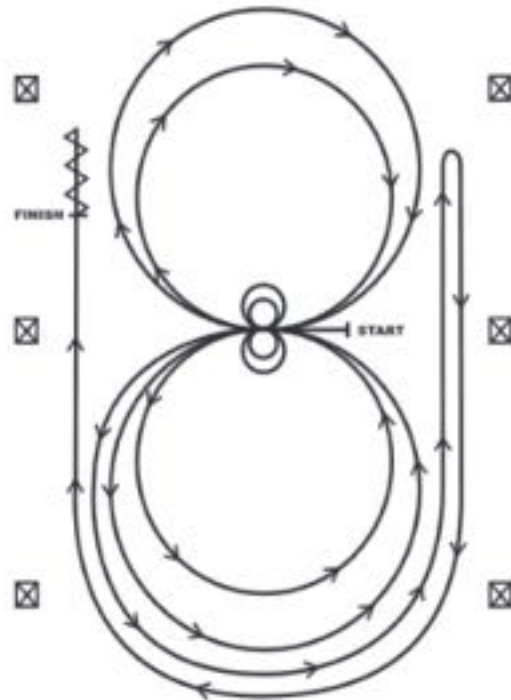

To be used for the Youth 10 & under Short Stirrup and Para-Reining only.

Horses may walk or jog to the center of the arena. Horses must walk or stop prior to starting the pattern. Beginning at the center of the arena facing the left wall or fence.

1. Beginning on the left lead, complete two circles to the left. Stop at the center of the arena. Hesitate.
2. Complete two spins to the left. Hesitate.
3. Beginning on the right lead complete two circles to the right. Stop at the center of the arena. Hesitate.
4. Complete two spins to the right. Hesitate.
5. Beginning on the left lead, go around the end of the arena, run down the right side of the arena past center marker, stop and roll back right.
6. Continue around the end of the arena to run down the left side of the arena past the center marker. Stop. Back up. Hesitate to demonstrate completion of the pattern.

NRHA Pattern B

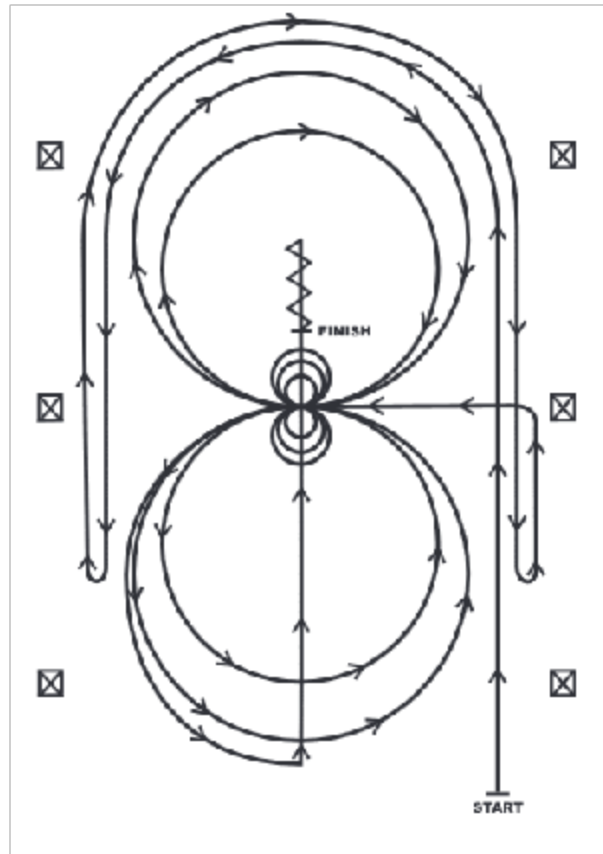

To be used for the Youth 10 & Under Short Stirrup and Para-Reining only.

1. Beginning, lope straight up the right side of the arena, circle the top of the arena run straight down the opposite or left side of the arena past the center mark and do a right rollback—no hesitation.
2. Continue straight up the left side of the arena circle back around the top of the arena run straight down the right side of the arena past the center marker and do a left rollback—no hesitation.
3. Continue up the right side of the arena to the center marker, at the center marker the horse should be on the left lead and complete two circles to the left, one large fast and one small slow. Stop at center. Hesitate.
4. Complete three spins to the left. Hesitate.
5. Complete two circles to the right, one large fast and one small slow. Stop at center. Hesitate.
6. Complete three spins to the right. Hesitate.
7. Begin a large circle to the left, do not close the circle. Continue up the center of the arena past the center marker and do a sliding stop. Back up at least ten feet. Hesitate to demonstrate completion of the pattern.

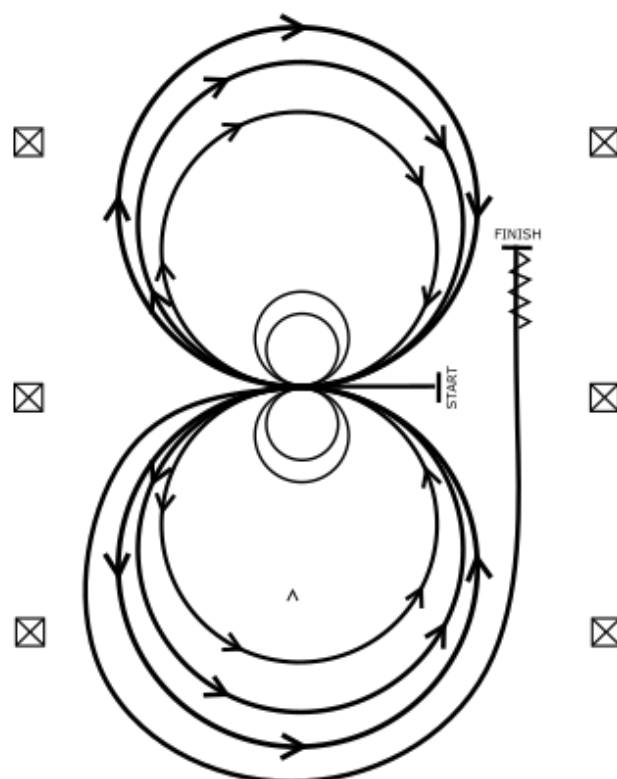

Riders may walk or jog to center of arena. Rider must walk or stop before loping off.

1. Lope off on the left lead. Complete one large fast circle and then on small slow circle. Stop in the middle of the arena. Hesitate.
2. Complete 2 spins to the left. Hesitate.
3. Lope off on the right lead. Complete one large fast circle and then on small slow circle. Stop in the middle of the arena. Hesitate.
4. Complete 2 spins to the right. Hesitate.
5. Beginning on the left lead, complete one large circle to the left, change leads in the center of the arena. Complete one large circle to the right. Change leads in the center of the arena.
7. Lope around the end of the arena. Do not close the circle. Continue straight past the center marker. Stop and back more than 4 steps. Hesitate to show completion of pattern.

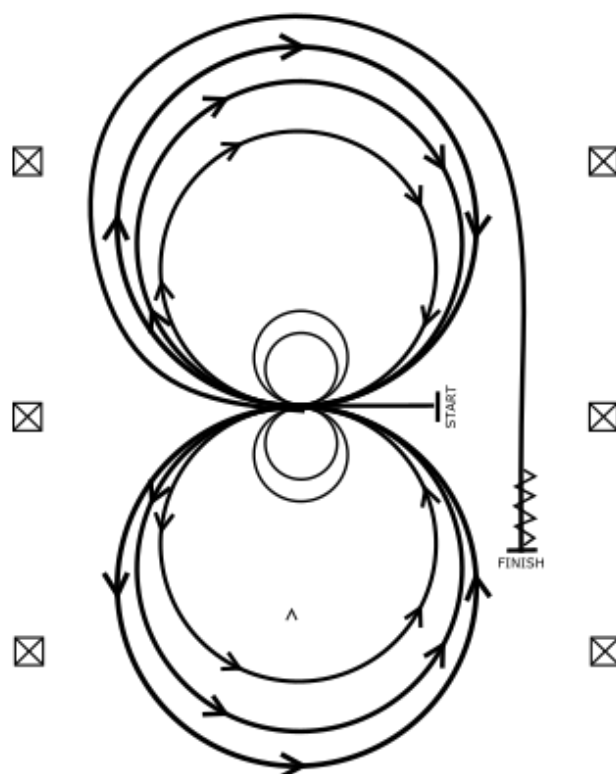

Riders may walk or jog to center of arena. Rider must walk or stop before loping off.

1. Lope off on the right lead. Complete one large fast circle and then on small slow circle. Stop in the middle of the arena. Hesitate.
2. Complete 2 spins to the right. Hesitate.
3. Lope off on the left lead. Complete one large fast circle and then on small slow circle. Stop in the middle of the arena. Hesitate.
4. Complete 2 spins to the left. Hesitate.
5. Beginning on the right lead, complete one large circle to the right, change leads in the center of the arena. Complete one large circle to the left. Change leads in the center of the arena.
7. Lope around the end of the arena. Do not close the circle. Continue straight past the center marker. Stop and back more than 4 steps. Hesitate to show completion of pattern.

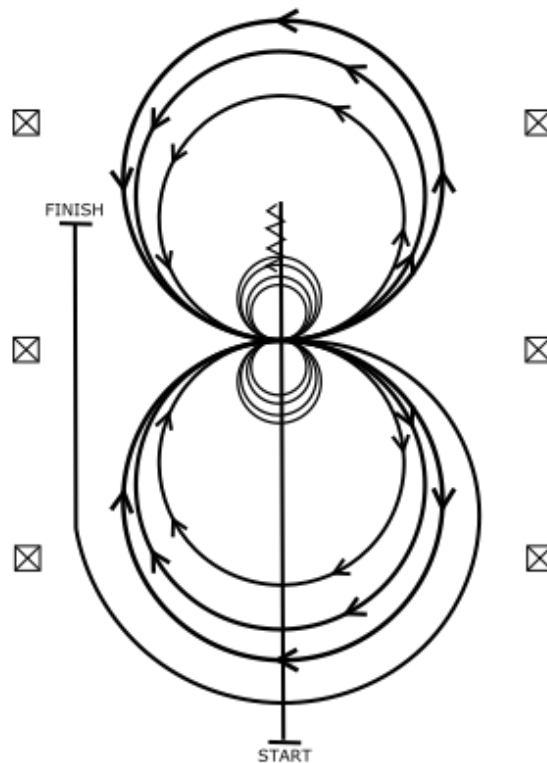

1. Run in past the center mark. Stop and back until even with center marker. Hesitate.
2. Spin 4 times to the left. Hesitate.
3. Spin 4 1/4 times to the right, so you are facing away from the judge. Hesitate.
4. Lope off on the right lead. Complete 3 circles. The first circle large and fast, the second circle small and slow and the third circle large and fast. Change leads at the center of the arena.
5. Complete 3 circles to the left. The first circle large and fast, the second circle small and slow and the third circle large and fast. Change leads at the center of the arena.
6. Lope off on the right lead. Go around the arena, but don't close the circle, run past the center marker. Stop and do not back up.

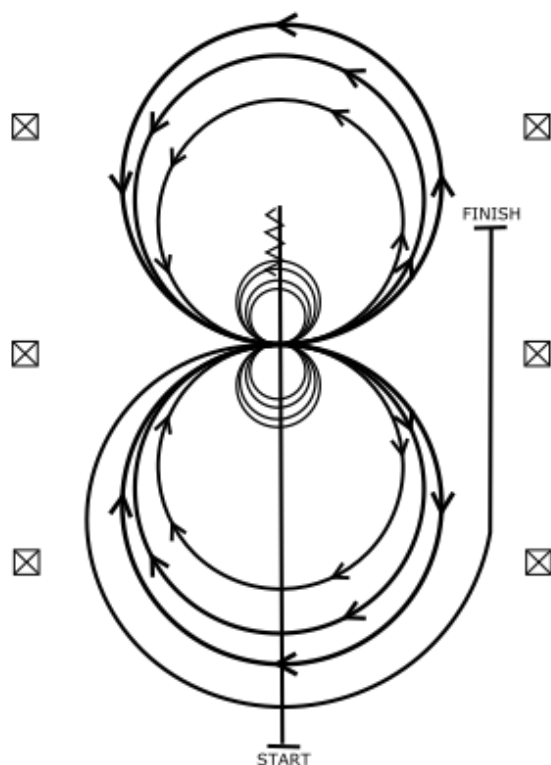

1. Run in past the center mark. Stop and back until even with center marker. Hesitate.
2. Spin 4 times to the right. Hesitate.
3. Spin 4 1/4 times to the left. Hesitate.
4. Lope off on the left lead. Complete 3 circles. The first circle large and fast, the second circle small and slow and the third circle large and fast. Change leads at the center of the arena.
5. Complete 3 circles to the right. The first circle large and fast, the second circle small and slow and the third circle large and fast. Change leads at the center of the arena.
6. Lope off on the left lead. Go around the arena, but don't close the circle, run past the center marker. Stop and do not back up.

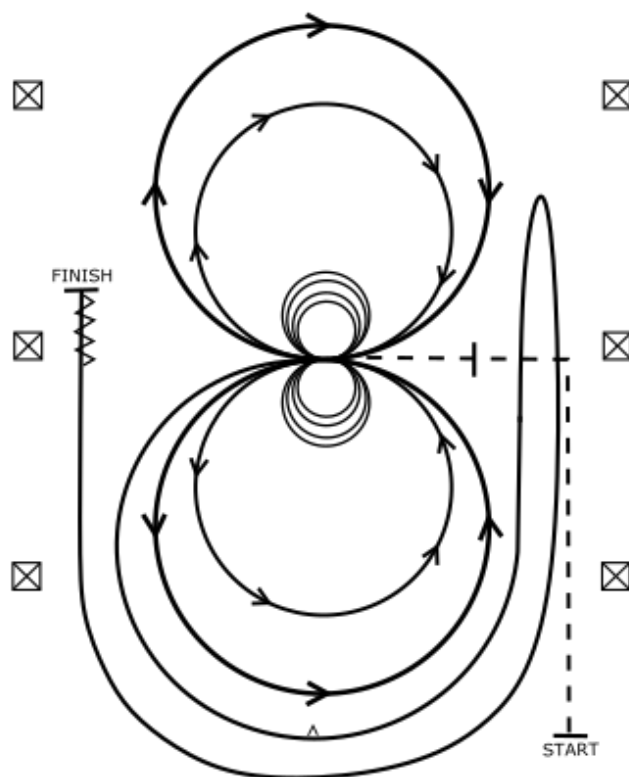

1. Jog to center of arena. Stop. Hesitate. Spin four spins to the right. Hesitate.
 2. Spin four spins to the left. Hesitate.
 3. Complete two circles to the left, the first small and slow, the second large and fast. Change leads at the center of the arena.
 4. Complete two circles to the right, the first small and slow, the second large and fast. Change leads at the center of the arena and head around the top of the arena but do not close the circle.
 5. Lope past the center cone and stop, then perform a right rollback.
 6. Lope around the end of the arena past the center cone and stop. Back.
- Hesitate to show completion of pattern.

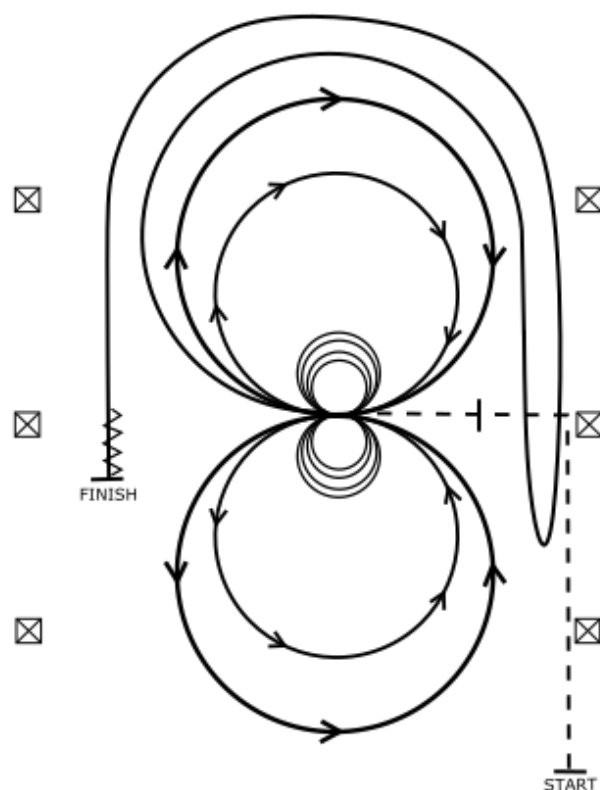

1. Jog to center of arena. Stop. Hesitate. Spin four spins to the left. Hesitate.
2. Spin four spins to the right. Hesitate.
3. Complete two circles to the right, the first small and slow, the second large and fast. Change leads at the center of the arena.
4. Complete two circles to the left, the first small and slow, the second large and fast. Change leads at the center of the arena and head around the top of the arena but do not close the circle.
5. Lope past the center cone and stop, then perform a left rollback.
6. Lope around the end of the arena past the center cone and stop. Back.

Hesitate to show completion of pattern.

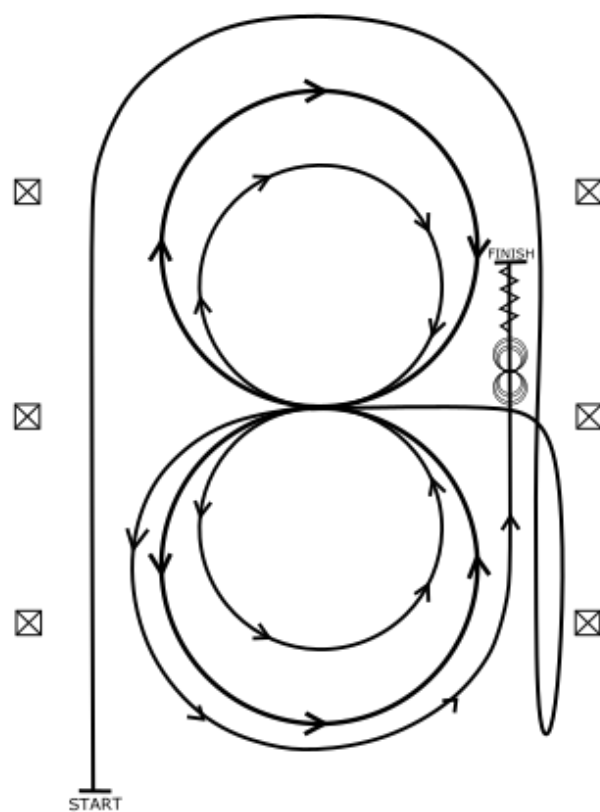

1. Lope straight up the left side of the arena, circle the top of the arena, then run straight down the right side of the arena past the center marker and do a left rollback. No hesitation.
2. Lope to center marker on the left lead and guide the horse to the center of the arena. Complete two circles to the left, the first large and fast, the second small and slow. Change leads at the center of the arena.
4. Complete two circles to the right, the first large and fast, the second small and slow. Change leads at the center of the arena.
5. Begin a large circle to the left but do not close this circle. Continue up the right side of the arena and run straight down past the center marker and stop. Back up.
6. Complete 4 spins to the left. Hesitate.
7. Complete 4 spins to the right. Hesitate to show completion of pattern.

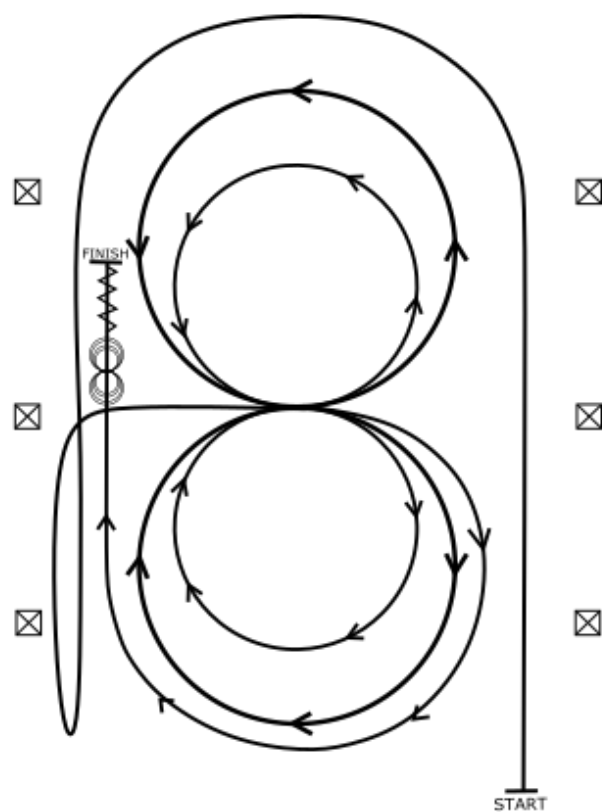

1. Lope straight up the right side of the arena, circle the top of the arena, then run straight down the left side of the arena past the center marker and do a right rollback. No hesitation.
2. Lope to center marker on the right lead and guide the horse to the center of the arena. Complete two circles to the right, the first small and slow, the second large and fast. Change leads at the center of the arena.
4. Complete two circles to the left, the first small and slow, the second large and fast. Change leads at the center of the arena.
5. Begin a large circle to the right but do not close this circle. Continue up the left side of the arena and run straight down past the center marker and stop. Back up.
6. Complete 4 spins to the right. Hesitate.
7. Complete 4 spins to the left. Hesitate to show completion of pattern.

9300 IHSA Reining Patterns.
IHSA OPEN REINING PATTERN #1

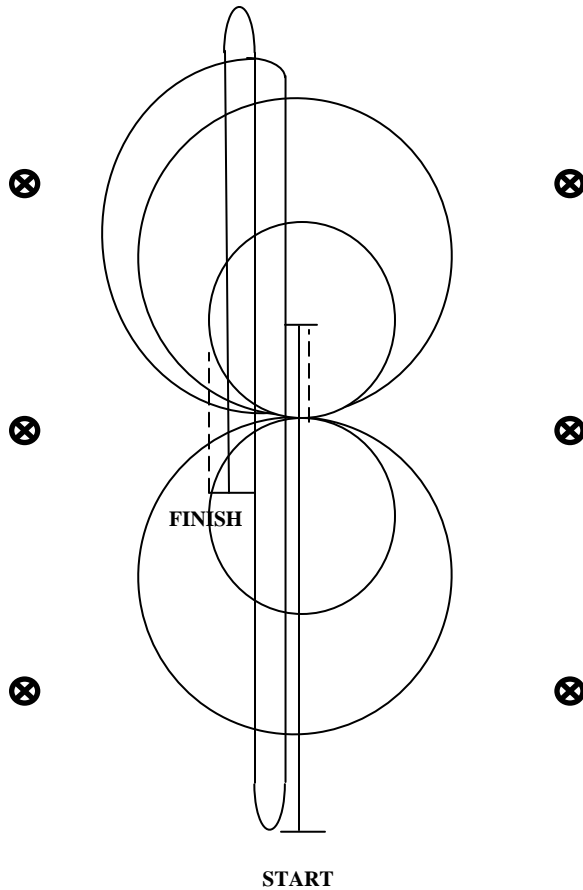

- a Lope down the center line of arena, just past the center marker.
- b Stop.
- c Back to the center of arena and settle horse for five seconds.
- d Pivot left ninety degrees.
- e Lope right lead to a small, slow circle to the right, inside the end marker.
- f Lope a large, fast circle to the right, outside of the end marker.
- g Simple change of leads at center of arena.
- h Lope small, slow circle to the left, inside the end marker.
- i Lope large, fast circle to the left
- j Simple change of lead.
- k Begin a large right circle, at the top of the circle lope down the middle to the far end of the arena past the end marker
- l Stop, do a right rollback and lope beyond the opposite end marker.
- m Stop, do a left rollback and lope.
- n Lope beyond the center marker.
- o Stop.
- p Back ten feet, settle horse for five seconds.

IHSA OPEN REINING PATTERN #2

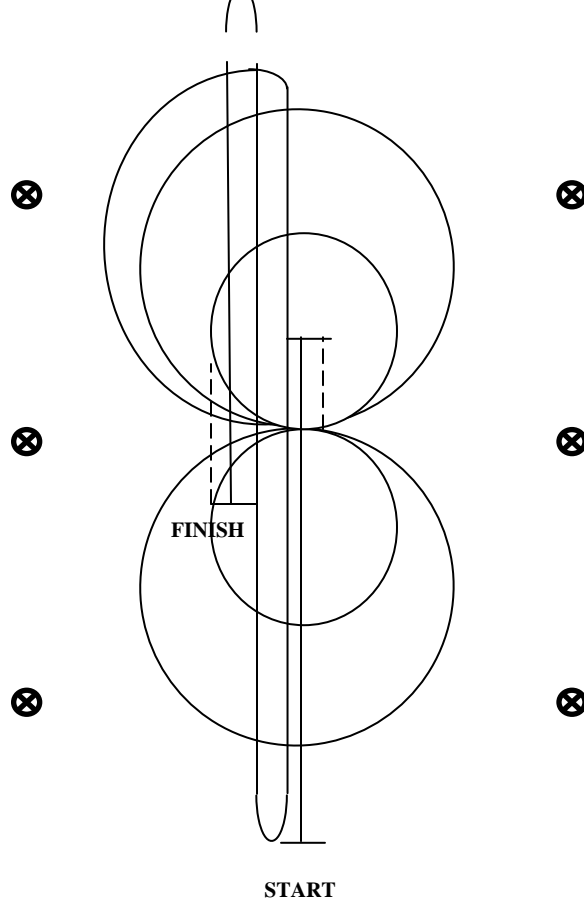

- a Lope down the center line of arena, just past the center marker.
- b Stop.
- c Back to the center of arena and settle horse for five seconds.
- d Pivot left ninety degrees.
- e Lope right lead to a small, slow circle to the right, inside the end marker.
- f Lope a large, fast circle to the right, outside of the end marker.
- g Flying change of leads at center of arena.
- h Lope small, slow circle to the left, inside the end marker.
- i Lope large, fast circle to the left
- j Flying change of lead.
- k Begin a large right circle, at the top of the circle lope down the middle to the far end of the arena past the end marker
- l Stop, do a right rollback and lope beyond the opposite end marker.
- m Stop, do a left rollback and lope.
- n Lope beyond the center marker.
- o Stop.
- p Back ten feet, settle horse for five seconds.

IHSA OPEN REINING PATTERN #3

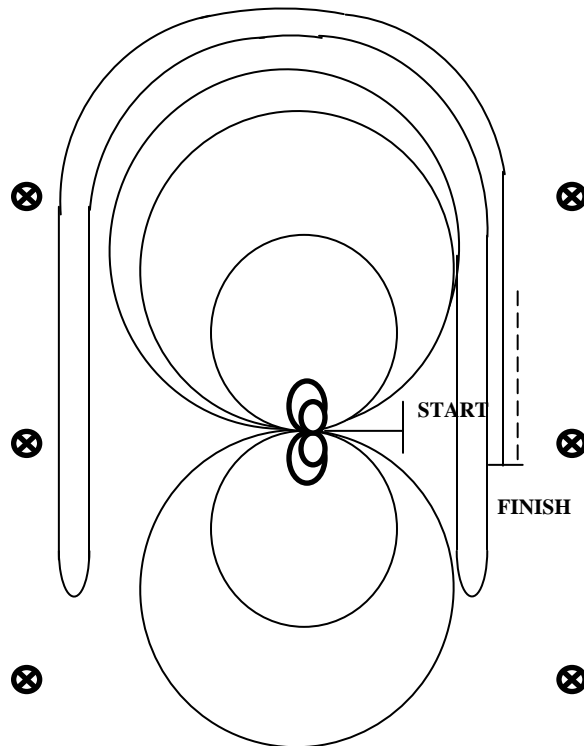

Walk horse to center of arena facing left fence or wall.

- a Complete two (2) spins to the left.
- b Complete two (2) spins to the right.
- c Beginning on the right lead, complete two (2) circles to the right, the first being slower and smaller, the second being faster and larger.
- d At the center of the arena, do a simple lead change.
- e Begin two (2) circles to the left, the first being slower and smaller, the second being faster and larger.
- f At the center of the arena, do a simple lead change.
- g Begin a large circle to the right, but do not close this circle. Lope down the right side of the arena past the center marker and stop. Do a left rollback.
- h Lope back around the previous circle, but do not close this circle. Lope down the left side of the arena past the center marker and stop. Do a right rollback.
- i Lope back around the previous circle but do not close this circle. Lope down the right side of the arena past the center marker, stop, and back. Settle.

IHSA OPEN REINING PATTERN #4

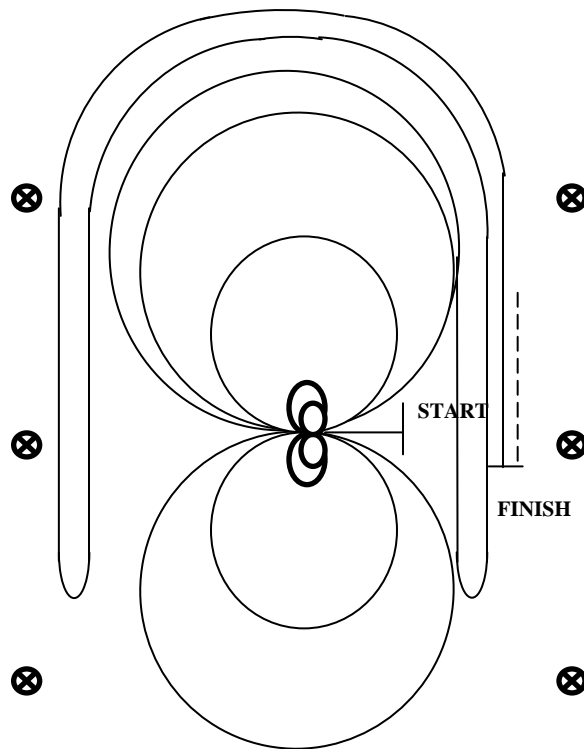

Walk horse to center of arena facing left fence or wall.

- a Complete two (2) spins to the left.
- b Complete two (2) spins to the right.
- c Beginning on the right lead, complete two (2) circles to the right, the first being slower and smaller, the second being faster and larger.
- d At the center of the arena, do a flying lead change.
- e Begin two (2) circles to the left, the first being slower and smaller, the second being faster and larger.
- f At the center of the arena, do a flying lead change.
- g Begin a large circle to the right, but do not close this circle. Lope down the right side of the arena past the center marker and stop. Do a left rollback.
- h Lope back around the previous circle, but do not close this circle. Lope down the left side of the arena past the center marker and stop. Do a right rollback.
- i Lope back around the previous circle but do not close this circle. Lope down the right side of the arena past the center marker, stop, and back. Settle.

IHSA OPEN REINING PATTERN #5

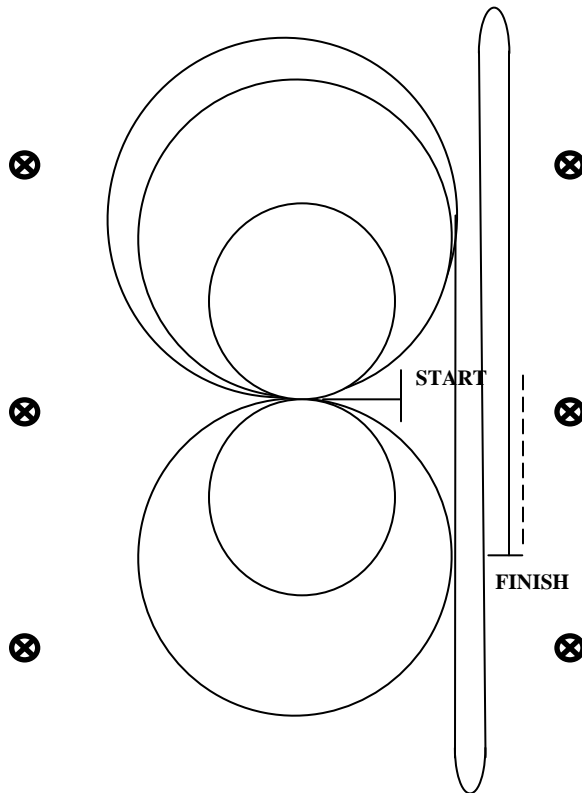

- a Begin from a halt at the center of the arena, facing the center marker on the left wall.
- b Lope a small, slow circle to the right.
- c Simple change at center.
- d Lope small, slow circle to the left.
- e Simple change at center.
- f Lope a large, fast circle to the right.
- g Simple change at center.
- h Lope large, fast circle to the left.
- i Simple change of lead at center.
- j Begin a large circle to the right, do not close this circle. Lope down the right side of the arena past the end marker.
- k Stop, rollback left to a lope.
- l Lope beyond opposite end marker.
- m Stop, rollback right to a lope.
- n Lope beyond the center marker.
- o Stop.
- p Back ten feet, settle the horse for five seconds.

IHSA OPEN REINING PATTERN #6

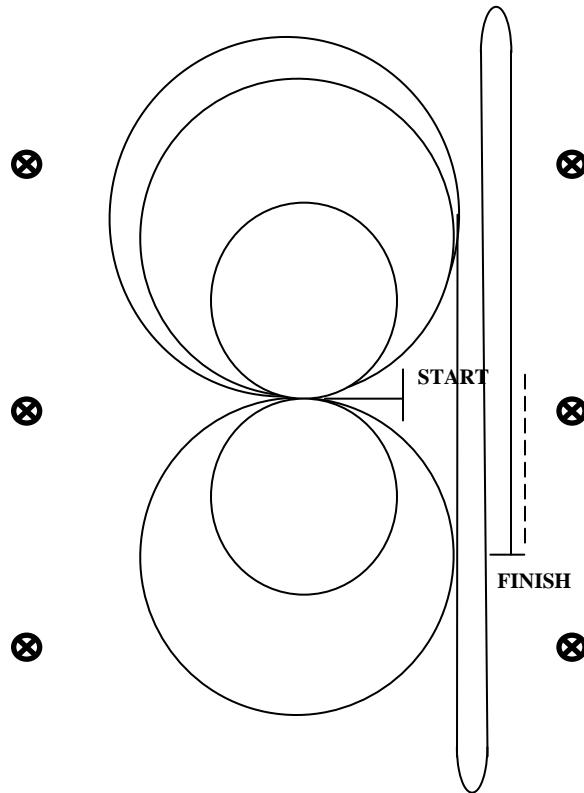

- a Begin from a halt at the center of the arena, facing the center marker on the left wall.
- b Lope a small, slow circle to the right.
- c Flying change at center.
- d Lope small, slow circle to the left.
- e Flying change at center.
- f Lope a large, fast circle to the right.
- g Flying change at center.
- h Lope large, fast circle to the left.
- i Flying change of lead at center.
- j Begin a large circle to the right, do not close this circle. Lope down the right side of the arena past the end marker.
- k Stop, rollback left to a lope.
- l Lope beyond opposite end marker.
- m Stop, rollback right to a lope.
- n Lope beyond the center marker.
- o Stop.
- p Back ten feet, settle the horse for five seconds.

IHSA OPEN REINING PATTERN #7

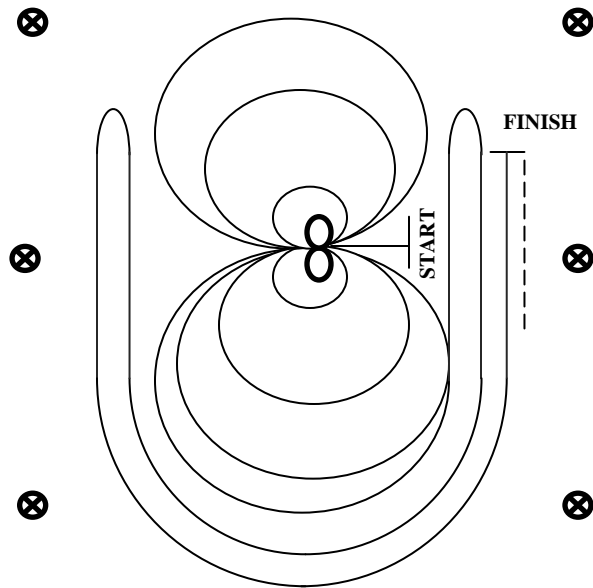

- a Starting at the center of the arena facing the left wall, begin on the left lead completing two (2) circles, the first being larger and faster, the second being smaller and slower.
- b At the center of the arena stop and complete one (1) 360 degree turn to the left.
- c Begin two (2) circles to the right, the first being larger and faster, the second being smaller and slower.
- d At the center of the arena stop and complete one (1) 360 degree turn to the right.
- e Starting on the left lead complete a large figure 8 with a simple lead change in the center.
- f Do a second simple lead change and begin a circle to the left, do not close this circle, lope down the right wall past the center marker
- g. Stop and do a right roll back.
- h Lope around to the other side of arena past the center maker and stop, do a left roll back.
- i Lope around to the other side of arena past the center marker, stop and back.

IHSA OPEN REINING PATTERN #8

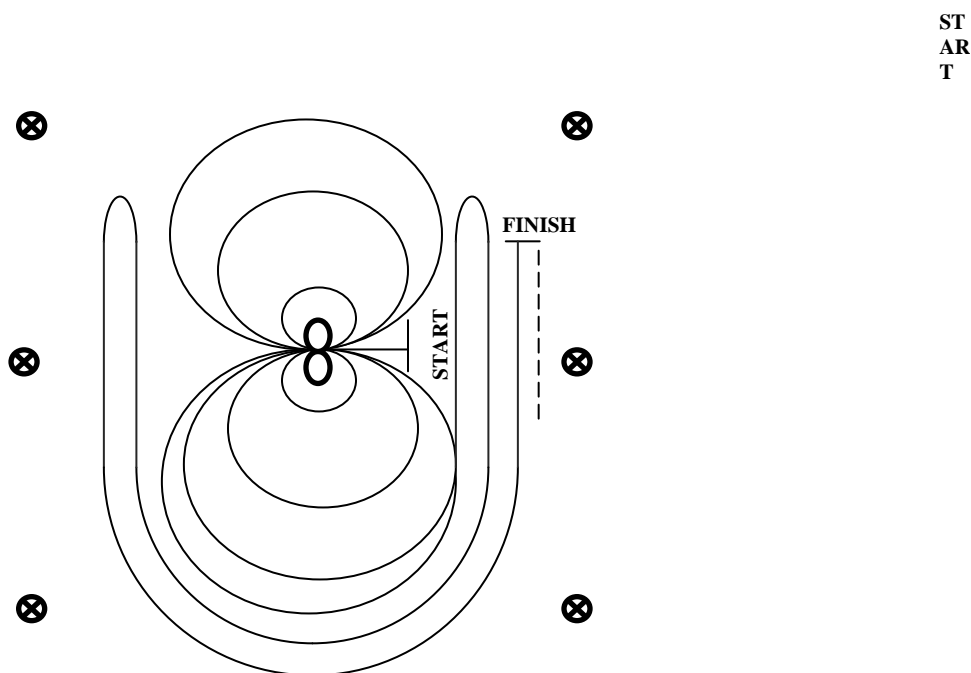

ST
AR
T

- a Starting at the center of the arena facing the left wall, begin on the left lead completing two (2) circles, the first being larger and faster, the second being smaller and slower.
- b At the center of the arena stop and complete one (1) 360 degree turn to the left.
- c Begin two (2) circles to the right, the first being larger and faster, the second being smaller and slower.
- d At the center of the arena stop and complete one (1) 360 degree turn to the right.
- e Starting on the left lead complete a large figure 8 with a flying lead change in the center.
- f Do a second flying lead change and begin a circle to the left, do not close this circle, lope down the right wall past the center marker
- g. Stop and do a right roll back.
- h Lope around to the other side of arena past the center maker and stop, do a left roll back.
- i Lope around to the other side of arena past the center marker, stop and back.

IHSA OPEN REINING PATTERN #9

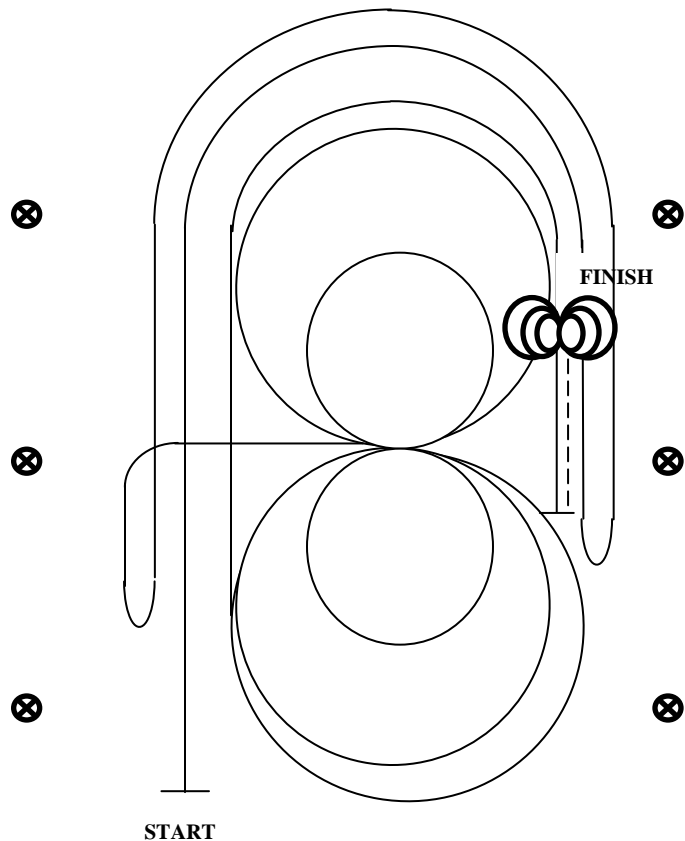

- a Starting on the left side wall, lope down around end wall, back up the right side past the center marker. Stop and roll back left.
- b Continue down right wall around end wall, back up left side past the center marker. Stop and roll back right.
- c Continue up left wall to center. At the center marker, horse should be on the right lead. Continue to the center of the arena.
- d At the center of the arena, complete two circles to the right, the first being large and fast, the second being slow and small.
- e Do a simple lead change and complete two circles to the left, the first being large and fast, the second being slow and small.
- f Do a simple lead change and begin a large circle to the right but do not close this circle. Continue up the left side around the end wall back down the right side past the center marker. Stop.
- g Back and hesitate.
- h Complete three spins to the right.
- i Complete three spins to the left.

IHSA OPEN REINING PATTERN #10

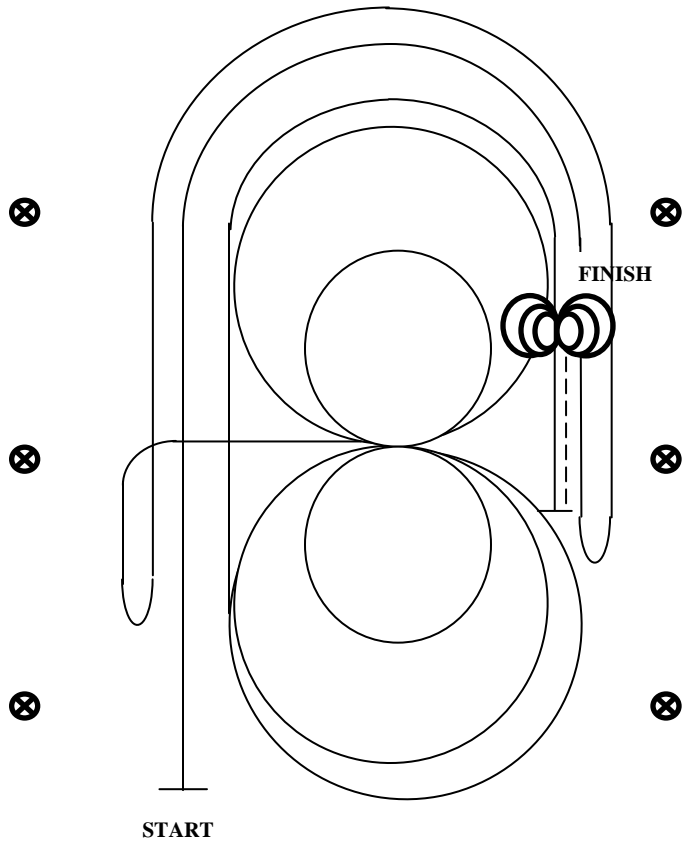

- a Starting on the left side wall, lope down around end wall, back up the right side past the center marker. Stop and roll back left.
- b Continue down right wall around end wall, back up left side past the center marker. Stop and roll back right.
- c Continue up left wall to center. At the center marker, horse should be on the right lead. Continue to the center of the arena.
- d At the center of the arena, complete two circles to the right, the first being large and fast, the second being slow and small.
- e Do a flying lead change and complete two circles to the left, the first being large and fast, the second being slow and small.
- f Do a flying lead change and begin a large circle to the right but do not close this circle. Continue up the left side around the end wall back down the right side past the center marker. Stop.
- g Back and hesitate.
- h Complete three spins to the right.
- i Complete three spins to the left.