

YOUTH EQUESTRIAN DEVELOPMENT ASSOCIATION

2018  
SUNBURY, OHIO



**YEDA**

NATIONAL CHAMPIONSHIP SHOW

APRIL 28-29, 2018  
EDEN PARK | SUNBURY, OHIO  
2607 BLAYNEY RD  
SUNBURY, OH 43074

# Middle School & High School Team

Adelynn Rich    Kathryn Clarke    Isabella O'Daniel    Hailey Vaughn  
Jillian Jefferson    Olivia England    Erin Keihl    Kayla Wall  
Shelby VanDenBosch    Lillian Alexander    Darby Welbaum    Olivia Keihl

# GOODLUCK AT THE 2018 YEDA NATIONALS



## Seniors

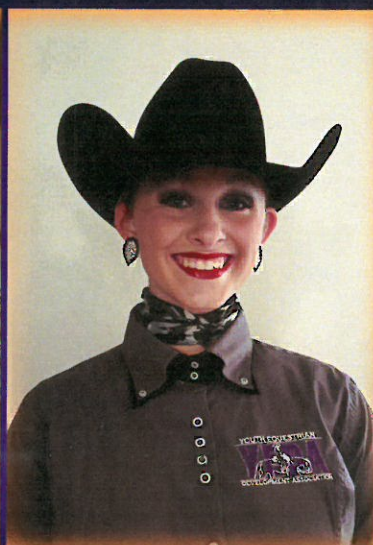
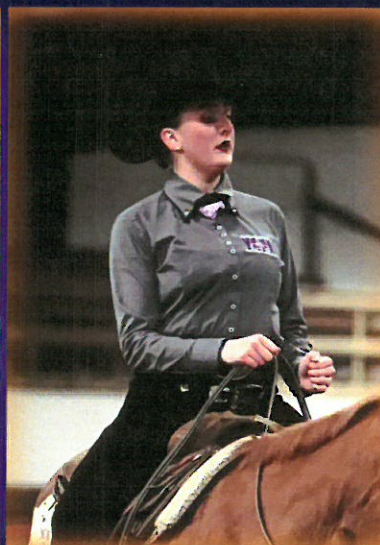

Matthew  
Siefker

Larkin  
Welbaum

Katzya  
Suerdick

Sierra  
Keller

# Puthoff

PERFORMANCE HORSES

LAURA, OH  
937-546-1505

# Bay Hill Farm

2017 NATIONAL CHAMPIONS  
HIGH SCHOOL TEAM



*Bay Hill Farm Equestrian Team would like to  
wish everyone the best of luck at Nationals!*

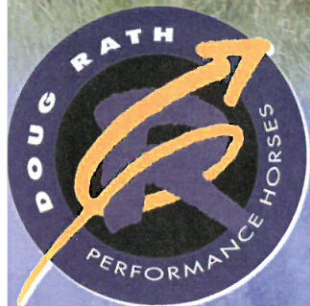

COACH TAMMY RATH  
2630 CARRIAGE RD | POWELL, OH 43065  
614-588-3316

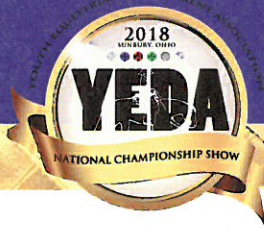

***Our mission is to provide an equestrian riding program for youth students, via both instructional and experiential learning opportunities. To accomplish this we will engage in equestrian competitions, instructional clinics, networking events and occasions for recruitment that includes but not limited to scholarship disbursements.***

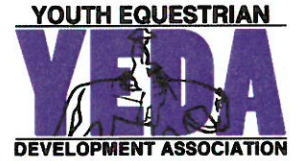

## Show Officials

### Judges

#### Judge A

John Tuckey  
Liberty, Kentucky

*Tie Breaker Judge for all odd numbered classes & Senior High School High Point Rider*

#### Judge B

Betsy Tuckey  
Liberty, Kentucky

*Tie Breaker Judge for all even numbered classes & Junior High School High Point Rider*

### Stewards

#### National Steward

Lori Arthur

#### Show Steward

Stephanie Steiner

#### Show Manager

Jenna Kingery

#### Show Secretary

Molly Niese

#### Point Secretary

Haley Bok

#### Announcer

Zac Brown

#### Medical Personal

Sue Ortiz RN

### National Anthem Singer

#### Saturday

Shayna Rigsby  
Junior High Sapphire  
Timmerman's Show Team

#### Sunday

Lily Dean  
Elementary Pearl Rider  
Southern Ohio Equestrian Team

### Patterns:

Individual Opal/Pearl Pattern #12

Individual Emerald Pattern #10

Individual Ruby Pattern #12

Individual Sapphire Pattern #11

Individual Diamond Pattern #10

Individual Diamond Reining Pattern #3

Team Opal Pattern #7

Team Emerald Pattern #8

Team Ruby Pattern #9

Team Sapphire Pattern #10

Team Diamond Pattern # 11

Team Diamond Reining Pattern #9

Diamond Elite Pattern #12



## TIE BREAKING RULES

### Two Judge Scoring

#### Combining Judges' Cards for the overall Placings:

The multiple judge system used for combining the judges' cards for the overall placings is a modified version of the AQHA Multiple Judge System found in the AQHA Rulebook. Judges will place the class independently, placing all riders on their card. Each placing will then be given a numerical score and then these scores are combined to determine the overall placings. See chart below for the numerical scores for each placing.

Placing	Scoring Points	Placing	Scoring Points	Placing	Scoring Points
1	120	6	55	11	15
2	105	7	45	12	10
3	91	8	36	13	6
4	78	9	28	14	3
5	66	10	21	15	1

### Tie Breaking Rules

#### Class Ties:

In the event of a tie in a class, it will be broken by the tiebreaker judges' card, not the score sheet. Judge A will break all odd numbered classes, and Judge B will break all even numbered classes.

#### High Point Rider Ties:

In the event of a tie in the individual high point rider competition, the tie will be broken by a horse knowledge question asked by the appointed judge. The tie breaker judge for the High School High Point Rider is Judge A. The tie breaker judge for the Junior High School High Point Rider will be broken by Judge B.

### Top 10 Team Placement Ties

#### Tie Breaking Rules:

In the event of a tie in the team standings, the tie will be broken by the team with the most number of first places, if still tied then the team with the most number of second places, if still tied this pattern will continue for 3<sup>rd</sup>, 4<sup>th</sup>, 5<sup>th</sup>, 6<sup>th</sup> places.

In the event this method does not break the tie; the high school team tie will be broken by the team who placed the highest in Diamond Rail/Pattern Team Horsemanship. The junior high tie will be then broken by the highest placing team in the Sapphire Rail Horsemanship. If neither team have a rider in the aforementioned class, then the tie will be broken using the next lower division rail horsemanship.

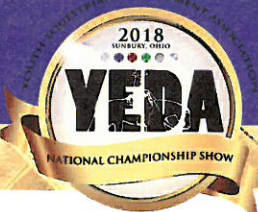

## TIME SCHEDULE: SATURDAY Individual Classes

**7:00am Coaches Meeting**

**7:30am Schooling of Horses**

**8:30 Horse Draw**

*\*\*\*Riders will be drawing the horses not the coaches, the rider or a representative for the rider needs to be there to draw the horse\*\*\**

**9:00 am Opening Ceremony**

Class 1. Individual Group 20 Senior High Diamond Division – Reining

**SPONSORED BY: MARCIA HIGNETT QUARTER HORSES**

Class 2. Individual Group 13 Senior High Emerald Rail Horsemanship

**SPONSORED BY: SAUDER PLEASURE HORSES**

Class 3. Individual Group 17 Senior High Sapphire Rail Horsemanship

**SPONSORED BY: LAKE ERIE COLLEGE**

Class 4. Individual Group 11 Senior High Opal Rail Horsemanship

**SPONSORED BY: NORTHERN OHIO QUARTER HORSE ASSOCIATION**

Class 5. Individual Group 15 Senior High Ruby Rail Horsemanship

**SPONSORED BY: CHRIS STRINE**

Class 6. Individual Group 19 Senior High Diamond Pattern/Rail Horsemanship

**SPONSORED BY: MIDWAY UNIVERSITY**

Class 7. Individual Group 21 Alumni Pattern & Rail Horsemanship

**SPONSORED BY: KATHY WILLIAMS TAIL EXTENSIONS**

Class 8. Individual Group 18 Senior High Sapphire Pattern Horsemanship

**SPONSORED BY: TIFFIN UNIVERSITY**

Class 9. Individual Group 16 Senior High Ruby Pattern Horsemanship

**SPONSORED BY: AMERICAN SOLUTIONS**

Class 10. Individual Group 12 Senior High Opal Pattern Horsemanship

**SPONSORED BY: MEDINA FARMERS EXCHANGE--NUTRENA**

Class 11. Individual Group 14 Senior High Emerald Pattern Horsemanship

**SPONSORED BY: ALBION COLLEGE**

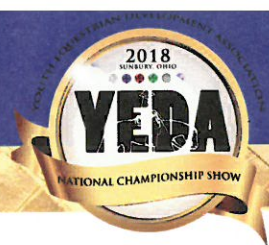

### **Lunch Break \* Team Parade**

*Senior Awards \* Scholarship Incentive Fund Presentation \* SR HiPt Rider Awards  
Tim McHugh and ROSS Scholarship Presentation*

Class 12. Individual Group 3 Junior High Opal Rail Horsemanship

**SPONSORED BY: OHIO PAINT HORSE CLUB**

Class 13. Individual Group 1 Elementary Pearl Rail Horsemanship Split A

**SPONSORED BY: ARNOLD SHOW HORSES**

Class 14. Individual Group 1 Elementary Pearl Rail Horsemanship Split B

**SPONSORED BY: HOLDIT MAGNETIC NUMBERS**

Class 15. Individual Group 9 Junior High Sapphire Rail Horsemanship

**SPONSORED BY: PARADISE LEATHERWORKS**

Class 16. Individual Group 7 Junior High Ruby Rail Horsemanship

**SPONSORED BY: MCHUGH CHRYSLER DODGE JEEP-RAM**

Class 17. Individual Group 5 Junior High Emerald Rail Horsemanship

**SPONSORED BY: ROSS ENVIRONMENTAL**

Class 18. Individual Group 10 Junior High Sapphire Pattern Horsemanship

**SPONSORED BY: BLACK HAWK COLLEGE**

Class 19. Individual Group 8 Junior High Ruby Pattern Horsemanship

**SPONSORED BY: THE OHIO STATE UNIVERSITY**

Class 20. Individual Group 1 Elementary Pearl Rail Horsemanship Finals

**SPONSORED BY: THE UNIVERSITY OF FINDLAY**

Class 21. Individual Group 6 Junior High Emerald Pattern Horsemanship

**SPONSORED BY: SCHNEIDERS & EQUIFUSE**

Class 22. Individual Group 4 Junior High Opal Pattern Horsemanship

**SPONSORED BY: MIAMI UNIVERSITY**

Class 23. Individual Group 2 Elementary Pearl Pattern Horsemanship

**SPONSORED BY: PATTY MCCARTIN SHOW HORSES**

### **Awards Presentation**

*Horse of the Day \* JR High Point Rider Awards  
EquiFUSE Best Grooming Award*

# ROSS<sup>®</sup>



**Ross Environmental Services, Inc.**

*A member of The RossWay Group<sup>®</sup>*

*Good  
luck to all  
exhibitors and  
congratulations!*





*“It’s the Easiest Buy You’ll Ever Make”*

**3420 N. Maple Ave.  
Zanesville, Ohio 43701  
Just South of the Mall**

**1-800-253-7644**

**OFFICE: 740-453-0663**

**FAX: 740-453-7631**

**[www.mchughdodgejeep.com](http://www.mchughdodgejeep.com)**

# LAKOTA OF OHIO

Official Trailer of the All American Quarter Horse Congress



## New & Used Horse Trailers

30 Minutes South of Columbus at Exit 75 on I-71

(740)426-6737 [www.Lakotaofohio.com](http://www.Lakotaofohio.com)

Sales~Service~Tack Store~Camping

419 651-4027

Chris A Strine

Approved Judge

APHA, PIHA, ABRA

1079 Gayle Court  
Ashland, Ohio 44805  
[chrisstrine1965@gmail.com](mailto:chrisstrine1965@gmail.com)



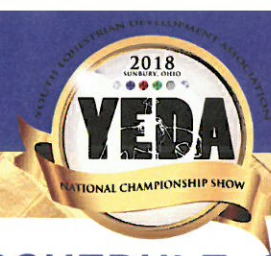

## TIME SCHEDULE: SUNDAY Team Classes

**7:00am Coaches Meeting**  
**7:30am Schooling of Horses**  
**8:30 Horse Draw**

*\*\*\*Riders will be drawing the horses not the coaches, the rider or a representative for the rider needs to be there to draw the horse\*\*\**

### **9:00 am Opening Ceremony**

- Class 1. Team Group 20 Senior High Diamond Division – Reining
- Class 2. Team Group 13 Senior High Emerald Rail Horsemanship
- Class 3. Team Group 11 Senior High Opal Rail Horsemanship
- Class 4. Team Group 5 Junior High Emerald Rail Horsemanship
- Class 5. Team Group 3 Junior High Opal Rail Horsemanship
- Class 6. Team Group 14 Senior High Emerald Pattern Horsemanship
- Class 7. Team Group 6 Junior High Emerald Pattern Horsemanship
- Class 8. Team Group 12 Senior High Opal Pattern Horsemanship
- Class 9. Team Group 4 Junior High Opal Pattern Horsemanship Team

### **Lunch Break**

#### **Coaches Walk Trot Horsemanship Class**

- Class 10. Team Group 17 Senior High Sapphire Rail Horsemanship
- Class 11. Team Group 15 Senior High Ruby Rail Horsemanship
- Class 12. Team Group 9 Junior High Sapphire Rail Horsemanship
- Class 13. Team Group 7 Junior High Ruby Rail Horsemanship
- Class 14. Team Group 18 Senior High Sapphire Pattern Horsemanship
- Class 15. Team Group 16 Senior High Ruby Pattern Horsemanship
- Class 16. Team Group 8 Junior High Ruby Pattern Horsemanship
- Class 17. Team Group 19 Senior High Diamond Pattern and Rail Horsemanship
- Class 18. Team Group 10 Junior High Sapphire Pattern Horsemanship
- Class 19. Individual Group 22 Diamond Elite Horsemanship

### **Awards Presentation 🌟 Team Parade**

*Horse of the Day 🌟 Team Awards 🌟 EquiFUSE Best Grooming Award  
Drawing for a Season of Free Entries Raffle*

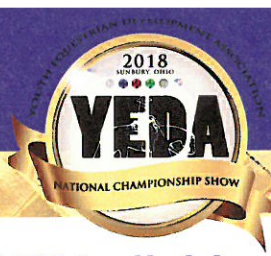

## SATURDAY Individual Classes April 28, 2018

**Class 1 Individual Group 20 Senior High Diamond Reining (10)**  
**SPONSORED BY: MARCIA HIGNETT QUARTER HORSES**

Back#	Name	Team	Draw	Horse
198	Violet Romanak	Arnold Equestrian Team		
339	Emily Coe	Bay Hill Farm		
223	Levi Mercer	Bay Hill Farm		
371	Madison Pendleton	Bay Hill Farm		
271	Nathan Sparren	Equine Differences		
101	Allison Sparks	Hancock Horseman		
151	Aria Morgan	Hancock Horseman		
487	Peyton Derr	Hancock Horseman		
355	Lexi Fosburg	M and M Equestrians		
390	Marissa Henry	M and M Equestrians		

1st: 151 2nd: 487 3rd: 198 4th: 101 5th: 371 6th: 390 7th: 339 8th: 355

2017 YEDA NATIONAL INDIVIDUAL CHAMPION: Madison Pendleton Bay Hill Farm

*Thank you, Lake Erie College for your  
generous \$3,000 Champion Scholarship and  
\$1,500 Reserve Scholarship for Juniors  
and Seniors in the Individual Classes!*



**Class 2 Individual Group 13 Senior High Emerald Rail Horsemanship (12)**  
**SPONSORED BY: SAUDER PLEASURE HORSES**

Back#	Name	Team	Draw	Horse
388	Carrie Leeper	Bay Hill Farm		
378	Emma Wirtz	Champion Hill Equestrian Team		
379	Isaiah Baughman	Hancock Horseman		
170	Ethan Baughman	Hancock Horseman		
102	Maria Ingle	Hancock Horseman		
141	Alyssa Detillion	KCPH Equestrian Team		
493	Tess Yuhaschek	M and M Equestrians		
373	Zack Moehrman	McColley Equestrian Team		
488	Dessa Weed	McColley Equestrian Team		
368	Lauren Goodyear	Silver Spur Equestrian Team		
428	Kyra Butts	Southern Ohio Equestrian Team		
221	Sarah Burneson	The Grimm Riders		

1st: 388 2nd: 488 3rd: 428 4th: 378 5th: 170 6th: 102 7th: 221 8th: 368

2017 YEDA NATIONAL INDIVIDUAL CHAMPION: McKenzie Schultz Hickory Ridge Equestrian

**Kah NURSERY**  
**937-596-6206**  
**937-596-6227 Fax**  
[www.kahnursery.com](http://www.kahnursery.com)

*YEDA would like to Thank Kah Nursery for the donation of the flowers and greenery for our National show and backdrop*

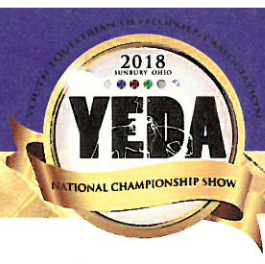

**Class 3 Individual Group 17 Senior High Sapphire Rail Horsemanship (12)**

**SPONSORED BY: LAKE ERIE COLLEGE**

<i>Back#</i>	<i>Name</i>	<i>Team</i>	<i>Draw</i>	<i>Horse</i>
367	Jessica Garvin	Arnold Equestrian Team		
123	Hannah Abfall	Arnold Equestrian Team		
211	Maryn Klaus	Arnold Equestrian Team		
344	Brianna Merklin	Bay Hill Farm		
449	Hailey Nelson	Bay Hill Farm		
481	Eli Wolfe	Equine Differences		
314	Madilyn Youngpeter	Hancock Horseman		
466	Jordan Schauer	Hancock Horseman		
112	Hannah Copley	Hickory Ridge Equestrian Team		
437	Chrissy Robers	Hickory Ridge Equestrian Team		
134	Brooklyn Wright	KCPH Equestrian Team		
166	Adison Miller	McColley Equestrian Team		

1st: 134 2nd: 112 3rd: 344 4th: 166 5th: 437 6th: 314 7th: 123 8th: 481

2017 YEDA NATIONAL INDIVIDUAL CHAMPION: Ciara Lawson Equine Differences

**Class 4 Individual Group 11 Senior High Opal Rail Horsemanship (10)**

**SPONSORED BY: NORTHERN OHIO QUARTER HORSE ASSOCIATION**

<i>Back#</i>	<i>Name</i>	<i>Team</i>	<i>Draw</i>	<i>Horse</i>
146	Jana Eicher	Bay Hill Farm		
155	Hailey Krzynowek	Champion Hill Equestrian Team		
304	Cori Reitmann	Equine Differences		
135	Victoria Ross	Hancock Horseman		
257	Kimberlyn Ousley	KCPH Equestrian Team		
263	Kalyn Dewey	McColley Equestrian Team		
234	Asya Modert	McColley Equestrian Team		
382	Hailey Vaughn	Puthoff Equestrian Team		
301	Abigail Shew	Timmermann's Show Team		
439	Kaitlin Vojacek	Triple Edge Equestrian Team		

1st: 146 2nd: 155 3rd: 439 4th: 234 5th: 304 6th: 257 7th: 135 8th: 263

2017 YEDA NATIONAL INDIVIDUAL CHAMPION: Zack Moehrman McColley Equestrian Team

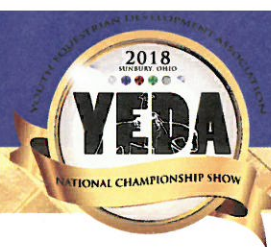

**Class 5 Individual Group 15 Senior High Ruby Rail Horsemanship (10)**

**SPONSORED BY: CHRIS STRINE**

331 Bailey VanDriest Arnold ET

Back#	Name	Team	Draw	Horse
219	Grace Murphy	Arnold Equestrian Team		
126	Kelsey Frame	Bay Hill Farm		
458	Sydney Mayer	Bay Hill Farm		
<del>181</del>	<del>Alyssa Rhoades</del>	<del>Bay Hill Farm</del>		<del>Scratch</del>
220	Bailey Deal	Bay Hill Farm		
334	Micaela Jackson	Equine Differences		
200	Katelynn Shellenberger	Hancock Horseman		
231	Taylor Klimmer	McColley Equestrian Team		
114	Mikaela Gleeson	McColley Equestrian Team		
296	Rachel Bowers	McColley Equestrian Team		

316 Sierra Keller Putnoff ET

1st: 331 2nd: 219 3rd: 334 4th: 220 5th: 114 6th: 231 7th: 316 8th: 126

2017 YEDA NATIONAL INDIVIDUAL CHAMPION: Mikayla Heintschel Hancock Horseman

**Class 6 Individual Group 19 Senior High Diamond Rail/Pattern Horsemanship (10)**

**SPONSORED BY: MIDWAY UNIVERSITY**

Back#	Name	Team	Draw	Horse
198	Violet Romanak	Arnold Equestrian Team		
339	Emily Coe	Bay Hill Farm		
271	Nathan Sparren	Equine Differences		
151	Aria Morgan	Hancock Horseman		
487	Peyton Derr	Hancock Horseman		
310	Sara Rosenberger	Hancock Horseman		
101	Allison Sparks	Hancock Horseman		
390	Marissa Henry	M and M Equestrians		
197	Lori Girrbach	McColley Equestrian Team		
202	Teryn Ferrell	Royal Creek Equestrian Team		

1st: 151 2nd: 197 3rd: 310 4th: 487 5th: 202 6th: 271 7th: 339 8th: 390

2017 YEDA NATIONAL INDIVIDUAL CHAMPION: Peyton Derr Hancock Horseman

# *YBPA Scholarship*

## **2018 SIF PAYOUTS:**

**EMILY COE**

**BAY HILL**

**BAILEY DEAL**

**BAY HILL**

**SIERRA KELLER**

**PUTOFF**

**STEPHANIE KSYWALIS**

**MEDINA**

**MADISON PENDLETON**

**BAY HILL**

**VIOLET ROMANAK**

**ARNOLD**

**SARA ROSENBERGER**

**HANCOCK**

**NATHAN SPARREN**

**EQD**

**ALYSSA RHOADES**

**BAY HILL**

**EVAN THOMAS**

**EQD**

**BROOKLYN WRIGHT**

**KCPH**

**POINT VALUE WAS \$7.97 PER POINT**



# *Incentive Fund*

*You can get paid too. Join!*

**136 PTS IN 2 SEASONS \$1083.92**

**124 PTS IN 2 SEASONS \$988.28**

**85 PTS IN 1 SEASON \$677.45**

**22 PTS IN 2 SEASONS \$175.34**

**28 PTS IN 1 SEASON \$223.16**

**129 PTS IN 2 SEASONS \$1028.13**

**99 PTS IN 2 SEASONS \$789.03**

**107 PTS IN 2 SEASONS \$852.79**

**112 PTS IN 2 SEASONS \$892.64**

**70 PTS IN 2 SEASONS \$557.90**

**155 PTS IN 2 SEASONS \$1235.35**

*Thank you to everyone who supported the Scholarship  
Incentive Fund with your generous donations*

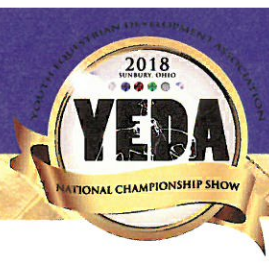

**Class 7 Individual Group 21 Alumni Rail/Pattern Horsemanship (5)**

**SPONSORED BY: KATHY WILLIAMS TAIL EXTENSIONS**

<i>Back#</i>	<i>Name</i>	<i>Team</i>	<i>Draw</i>	<i>Horse</i>
187	Adriana Grimm	Champion Hill Equestrian Team		
346	Britleigh Goodman	Champion Hill Equestrian Team		
356	Savannah Miletì	Equine Differences		
451	Kelli Haudenschild	Hancock Horseman		
362	Madison Brown	Southern Ohio Equestrian Team		

1st: 346 2nd: 187 3rd: 451 4th: 362 5th: 356

**Class 8 Individual Group 18 Senior High Sapphire Pattern Horsemanship (11)**

**SPONSORED BY: TIFFIN UNIVERSITY**

<i>Back#</i>	<i>Name</i>	<i>Team</i>	<i>Draw</i>	<i>Horse</i>
211	Maryn Klaus	Arnold Equestrian Team		
367	Jessica Garvin	Arnold Equestrian Team		
449	Hailey Nelson	Bay Hill Farm		
344	Brianna Merklin	Bay Hill Farm		
481	Eli Wolfe	Equine Differences		
442	Kylee Simpson	Hancock Horseman		
112	Hannah Copley	Hickory Ridge Equestrian Team		
134	Brooklyn Wright	KCPH Equestrian Team		
232	Zoey Howell	M and M Equestrians		
166	Adison Miller	McColley Equestrian Team		
176	Matthew Siefker	Puthoff Equestrian Team		

1st: 166 2nd: 442 3rd: 112 4th: 367 5th: 176 6th: 481 7th: 211 8th: 134

2017 YEDA NATIONAL INDIVIDUAL CHAMPION: Sara Rosenberger Hancock Horseman



**Class 9 Individual Group 16 Senior High Ruby Pattern Horsemanship (11)**

**SPONSORED BY: AMERICAN SOLUTIONS**

<i>Back#</i>	<i>Name</i>	<i>Team</i>	<i>Draw</i>	<i>Horse</i>
335	Hannah Hershner	Arnold Equestrian Team		
331	Bailey VanDriest	Arnold Equestrian Team		
485	Zoe Bricker	Bay Hill Farm		
329	Dane Creps	Hancock Horseman		
200	Katelynn Shellenberger	Hancock Horseman		
414	Roxanne Simpson	Hancock Horseman		
347	Austen Nissen	Hancock Horseman		
296	Rachel Bowers	McColley Equestrian Team		
114	Mikaela Gleeson	McColley Equestrian Team		
436	Katzya Suerdick	Puthoff Equestrian Team		
316	Sierra Keller	Puthoff Equestrian Team		

1st: 316 2nd: 114 3rd: 296 4th: 331 5th: 347 6th: 436 7th: 329 8th: 335

2017 YEDA NATIONAL INDIVIDUAL CHAMPION: Brooklyn Wright Hancock Horseman

**Class 10 Individual Group 12 Senior High Opal Pattern Horsemanship (10)**

**SPONSORED BY: MEDINA FARMERS EXCHANGE--NUTRENA**

<i>Back#</i>	<i>Name</i>	<i>Team</i>	<i>Draw</i>	<i>Horse</i>
146	Jana Eicher	Bay Hill Farm		
304	Cori Reitmann	Equine Differences		
309	Sydney Coy	Hancock Horseman		
135	Victoria Ross	Hancock Horseman		
257	Kimberlyn Ousley	KCPH Equestrian Team		
263	Kalyn Dewey	McColley Equestrian Team		
234	Asya Modert	McColley Equestrian Team		
382	Hailey Vaughn	Puthoff Equestrian Team		
174	Sarah Twine	Southern Ohio Equestrian Team		
439	Kaitlin Vojacek	Triple Edge Equestrian Team		

1st: 174 2nd: 257 3rd: 146 4th: 382 5th: 135 6th: 263 7th: 309 8th: 439



**Class 11 Individual Group 14 Senior High Emerald Pattern Horsemanship (11)**  
**SPONSORED BY: ALBION COLLEGE**

<i>Back#</i>	<i>Name</i>	<i>Team</i>	<i>Draw</i>	<i>Horse</i>
388	Carrie Leeper	Bay Hill Farm		
378	Emma Wirtz	Champion Hill Equestrian Team		
170	Ethan Baughman	Hancock Horseman		
141	Alyssa Detillion	KCPH Equestrian Team		
493	Tess Yugashek	M and M Equestrians		
199	Brooke Miller	McColley Equestrian Team		
488	Dessa Weed	McColley Equestrian Team		
424	Larkin Welbaum	Puthoff Equestrian Team		
368	Lauren Goodyear	Silver Spur Equestrian Team		
428	Kyra Butts	Southern Ohio Equestrian Team		
221	Sarah Burneson	The Grimm Riders		

1st: 428 2nd: 488 3rd: 170 4th: 199 5th: 388 6th: 493 7th: 141 8th: 424



**Class 12 Individual Group 3 Junior High Opal Rail Horsemanship (11)**  
**SPONSORED BY: OHIO PAINT HORSE CLUB**

<i>Back#</i>	<i>Name</i>	<i>Team</i>	<i>Draw</i>	<i>Horse</i>
208	Hannah Whitney	Arnold Equestrian Team		
110	Ainsley Rhoades	Bay Hill Farm		
148	Kaila Kocsis	Edge Equestrian		
118	Jocelyn Taylor	Equine Differences		
227	Anna Divis	Hancock Horseman		
383	Lexi Edwards	Hancock Horseman		
369	Kaylyn Warthman	Hickory Ridge Equestrian Team		
418	Evan McColley	McColley Equestrian Team		
348	Kendra Hochstedler	McColley Equestrian Team		
486	Olivia England	Puthoff Equestrian Team		
282	Lillian Alexander	Puthoff Equestrian Team		

1st: 110 2nd: 227 3rd: 383 4th: 208 5th: 148 6th: 348 7th: 486 8th: 282

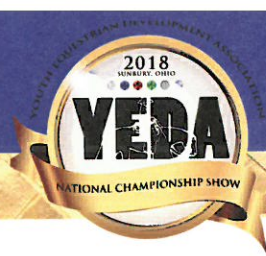

**Class 13 Individual Group 1 Elementary Pearl Rail Horsemanship Semi Finals Split A (8)**  
**SPONSORED BY: ARNOLD SHOW HORSES**

<i>Back#</i>	<i>Name</i>	<i>Team</i>	<i>Draw</i>	<i>Horse</i>
230	Danika Denman	Arnold Equestrian Team		
480	Evelyn Dipiero	Bay Hill Farm		
240	Eavan Clark	Bay Hill Farm		
115	Samantha Miller	Caustelot Farms		
105	Arianna Smith	Hancock Horseman		
133	Kaya Strausbaugh	Hancock Horseman		
274	Adelynn Rich	Puthoff Equestrian Team		
142	Kylee Rigsby	Timmermann's Show Team		

**Class 14 Individual Group 1 Elementary Pearl Rail Horsemanship Semi Finals Split B (7)**  
**SPONSORED BY: HOLDIT MAGNETIC NUMBERS**

<i>Back#</i>	<i>Name</i>	<i>Team</i>	<i>Draw</i>	<i>Horse</i>
278	Molly Hobbs	Bay Hill Farm		
269	Emelia Dipierro	Bay Hill Farm		
149	Kate Simmons	Hancock Horseman		
446	Marina Fox	Hancock Horseman		
206	Isabella Ellerbrock	Hancock Horseman		
241	Dixie McKibbin	McColley Equestrian Team		
292	Jillian Jefferson	Puthoff Equestrian Team		

*The Top 4 from each Semi Finals will be invited back to the Finals plus any true ties for 4<sup>th</sup> place.*

sstack.com

**SCHNEIDERS**

*A proud sponsor of the:*  
 Youth Equestrian Development  
 Association

equi**FUSE**  
 Outshine the competition!

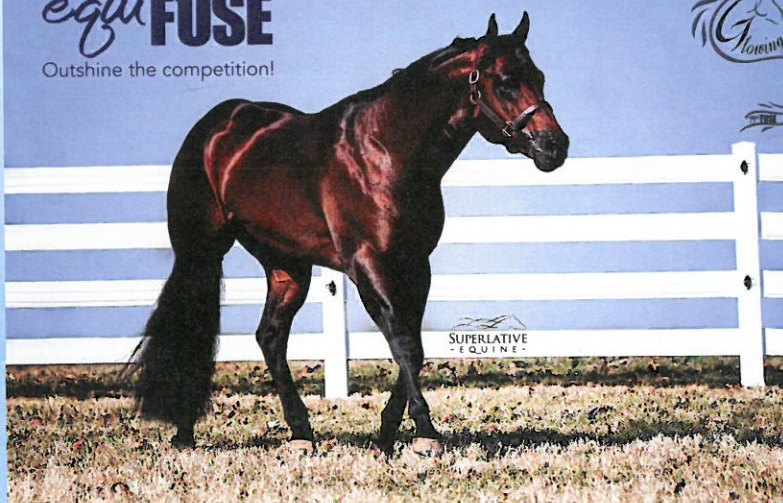

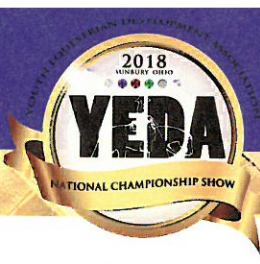

**Class 15 Individual Group 9 Junior High Sapphire Rail Horsemanship (10)**  
**SPONSORED BY: PARADISE LEATHERWORKS**

<i>Back#</i>	<i>Name</i>	<i>Team</i>	<i>Draw</i>	<i>Horse</i>
479	Katelynn Smeltzer	Arnold Equestrian Team		
260	Ava Coughlin	Bay Hill Farm		
117	Olivia Lott	Edge Equestrian		
140	Quinn Foor	Equine Differences		
400	Lauren Ferguson	Equine Differences		
496	Grace Heintschel	Hancock Horseman		
154	Gracie Casebolt	Hancock Horseman		
459	Katie Ruffener	KCPH Equestrian Team		
160	Violet Shetler	M and M Equestrians		
121	Alyvia Dixon	McColley Equestrian Team		

1st: 121 2nd: 160 3rd: 154 4th: 400 5th: 479 6th: 459 7th: 117 8th: 140

2017 YEDA NATIONAL INDIVIDUAL CHAMPION: Grace Casebolt Hancock Horseman

**Class 16 Individual Group 7 Junior High Ruby Rail Horsemanship (10)**  
**SPONSORED BY: MCHUGH CHRYSLER DODGE JEEP-RAM**

<i>Back#</i>	<i>Name</i>	<i>Team</i>	<i>Draw</i>	<i>Horse</i>
201	Paige Mullins	Arnold Equestrian Team		
264	Chloe Jansen	Equine Differences		
492	Benjy Norton	Equine Differences		
288	Madison Gordon	Equine Differences		
438	Skylar Super	Hancock Horseman		
165	Taylor Nelson	KCPH Equestrian Team		
228	Isabella O'Daniel	Puthoff Equestrian Team		
236	Macee Roberts	Royal Creek Equestrian Team		
249	Adrianna Runzo	Silver Spur Equestrian Team		
476	Mekenzie Stiffler	Triple Edge Equestrian Team		

1st: 264 2nd: 288 3rd: 236 4th: 438 5th: 228 6th: 476 7th: 492 8th: 201

2017 YEDA NATIONAL INDIVIDUAL CHAMPION: Grace Cromling Equine Differences

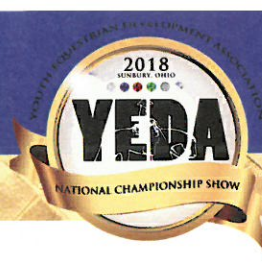

**Class 17 Individual Group 5 Junior High Emerald Rail Horsemanship (10)**

**SPONSORED BY: ROSS ENVIRONMENTAL**

<i>Back#</i>	<i>Name</i>	<i>Team</i>	<i>Draw</i>	<i>Horse</i>
462	Jada Lowery	Arnold Equestrian Team		
137	Kennedy Kirkham	Bay Hill Farm		
490	Sidney Hawk	Champion Hill Equestrian Team		
233	Kendall Bauman	Edge Equestrian		
191	Hayden Miller	Equine Differences		
393	Elijah Baughman	Hancock Horseman		
279	Samantha Wagner	Hancock Horseman		
259	Riley Long	McColley Equestrian Team		
413	Madelyn Kvicala	McColley Equestrian Team		
295	Dakota Prater	Triple Edge Equestrian Team		

1st: 413 2nd: 259 3rd: 490 4th: 233 5th: 137 6th: 462 7th: 279 8th: 295

2017 YEDA NATIONAL INDIVIDUAL CHAMPION: Mekenzie Stiffler Triple Edge Equestrian

**Class 18 Individual Group 10 Junior High Sapphire Pattern Horsemanship (10)**

**SPONSORED BY: BLACK HAWK COLLEGE**

<i>Back#</i>	<i>Name</i>	<i>Team</i>	<i>Draw</i>	<i>Horse</i>
479	Katelynn Smeltzer	Arnold Equestrian Team		
140	Quinn Foor	Equine Differences		
496	Grace Heintschel	Hancock Horseman		
154	Gracie Casebolt	Hancock Horseman		
459	Katie Ruffener	KCPH Equestrian Team		
160	Violet Shetler	M and M Equestrians		
121	Alyvia Dixon	McColley Equestrian Team		
394	Darby Welbaum	Puthoff Equestrian Team		
255	Erin Ortiz	The Grimm Riders		
312	Shayna Rigsby	Timmermann's Show Team		

1st: 160 2nd: 459 3rd: 154 4th: 496 5th: 121 6th: 479 7th: 140 8th: 255

2017 YEDA NATIONAL INDIVIDUAL CHAMPION: Brianna Merklin Bay Hill Farm

A photograph of a person wearing a black cowboy hat, a purple long-sleeved shirt, and black pants, riding a dark brown horse. The rider is wearing an orange western saddle and is holding the reins. The horse is standing in a sandy arena with a white and red striped fence in the background. The sky is a mix of blue and green, suggesting a sunset or sunrise. The overall scene is set against a dark green background that transitions into a lighter green at the top.

**CONGRATULATIONS  
YEDA RIDERS!**

# RIDE

**LAKE ERIE COLLEGE IS GOING WESTERN**

- Western seat riding classes for credit in 3 equine studies majors
- Ride with our IHSA western team

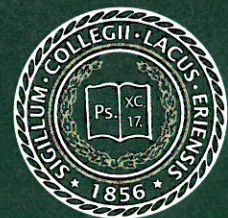

LEARN MORE AT [LEC.EDU/WESTERN](http://LEC.EDU/WESTERN) | 1.855.GO.STORM

**LAKE ERIE**  
COLLEGE



**SENIOR LIVING.**

**REDEFINED.**

**NEW SAFECHOICE® SENIOR RESETS YOUR EXPECTATIONS FOR WHAT HORSE FEED CAN BE.**

New SafeChoice® Senior supports immune response, contributes to a healthy body condition and helps lower the risk of metabolic concerns. Prebiotics and probiotics aid in nutrient digestion and digestive health. So your senior can look and act like a junior. Revisit what senior can be. **Visit [SafeChoiceFeed.com](http://SafeChoiceFeed.com).**



*Exclusive Nutri-Bloom Advantage™ increases fiber digestion up to 15% for better health and bloom.*

©2013 Cargill, Incorporated. All Rights Reserved.



 **Nutrena**  
Nutrition for a lifetime.™

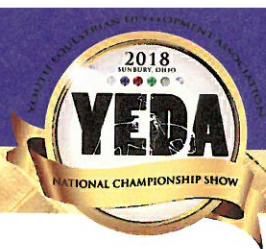

**Class 19 Individual Group 8 Junior High Ruby Pattern Horsemanship (10)**  
**SPONSORED BY: THE OHIO STATE UNIVERSITY**

Back#	Name	Team	Draw	Horse
218	Evan Merklin	Bay Hill Farm		
288	Madison Gordon	Equine Differences		
264	Chloe Jansen	Equine Differences		
492	Benjy Norton	Equine Differences		
438	Skylar Super	Hancock Horseman		
165	Taylor Nelson	KCPH Equestrian Team		
242	Erin Keihl	Puthoff Equestrian Team		
228	Isabella O'Daniel	Puthoff Equestrian Team		
236	Macee Roberts	Royal Creek Equestrian Team		
476	Mekenzie Stiffler	Triple Edge Equestrian Team		

1st: 438 2nd: 288 3rd: 492 4th: 264 5th: 242 6th: 165 7th: 236 8th: 476

2017 YEDA NATIONAL INDIVIDUAL CHAMPION: Lauren Ferguson Equine Differences

**Class 20 Individual Group 1 Elementary Pearl Rail Horsemanship Finals**  
**SPONSORED BY: THE UNIVERSITY OF FINDLAY**

Back#	Name	Team	Draw	Horse
240	Eavan Clark	Bay Hill Farm		
274	Adelynn Rich	Puthoff Equestrian Team		
230	Danika Denman	Arnold Equestrian Team		
480	Evelyn Dipiero	Bay Hill Farm		
133	Kaya Strausbaugh	Hancock Horseman		
269	Emelia Dipiero	Bay Hill Farm		
149	Kate Simmons	Hancock Horseman		
206	Isabella Ellerbrock	Hancock Horseman		

278 Molly Hobbs Bay Hill Farm

1st: 240 2nd: 149 3rd: 206 4th: 133 5th: 269 6th: 230 7th: 480 8th: 278

2017 YEDA NATIONAL INDIVIDUAL CHAMPION: Dakota Prater Triple Edge Equestrian

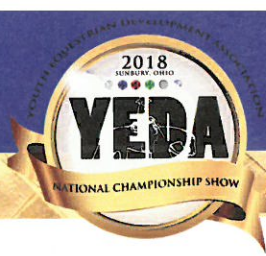

**Class 21 Individual Group 6 Junior High Emerald Pattern Horsemanship (10)**  
**SPONSORED BY: SCHNEIDERS & EQUIFUSE**

<i>Back#</i>	<i>Name</i>	<i>Team</i>	<i>Draw</i>	<i>Horse</i>
462	Jada Lowery	Arnold Equestrian Team		
137	Kennedy Kirkham	Bay Hill Farm		
490	Sidney Hawk	Champion Hill Equestrian Team		
233	Kendall Bauman	Edge Equestrian		
376	Skylar Twite	Equine Differences		
191	Hayden Miller	Equine Differences		
279	Samantha Wagner	Hancock Horseman		
259	Riley Long	McColley Equestrian Team		
413	Madelyn Kvicala	McColley Equestrian Team		
295	Dakota Prater	Triple Edge Equestrian Team		

1st: 376 2nd: 462 3rd: 137 4th: 490 5th: 233 6th: 191 7th: 295 8th: 279

**Class 22 Individual Group 4 Junior High Opal Pattern Horsemanship (10)**  
**SPONSORED BY: MIAMI UNIVERSITY**

<i>Back#</i>	<i>Name</i>	<i>Team</i>	<i>Draw</i>	<i>Horse</i>
208	Hannah Whitney	Arnold Equestrian Team		
110	Ainsley Rhoades	Bay Hill Farm		
227	Anna Divis	Hancock Horseman		
383	Lexi Edwards	Hancock Horseman		
125	Abby Kerns	Hickory Ridge Equestrian Team		
317	Luke Arnold	KCPH Equestrian Team		
418	Evan McColley	McColley Equestrian Team		
348	Kendra Hochstedler	McColley Equestrian Team		
486	Olivia England	Puthoff Equestrian Team		
282	Lillian Alexander	Puthoff Equestrian Team		

1st: 383 2nd: 227 3rd: 110 4th: 208 5th: 317 6th: 486 7th: 282 8th: 418

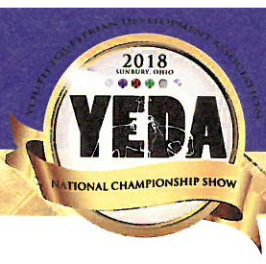

**Class 23 Individual Group 2 Elementary Pearl Pattern Horsemanship (16)**  
**SPONSORED BY: PATTY MCCARTIN SHOW HORSES**

<i>Back#</i>	<i>Name</i>	<i>Team</i>	<i>Draw</i>	<i>Horse</i>
230	Danika Denman	Arnold Equestrian Team		
480	Evelyn Dipiero	Bay Hill Farm		
244	Katie Wilson	Bay Hill Farm		
115	Samantha Miller	Caustelot Farms		
105	Arianna Smith	Hancock Horseman		
446	Marina Fox	Hancock Horseman		
389	Sydney Preston	M and M Equestrians		
311	Emma Zgrebnak	M and M Equestrians		
107	Ayla Ruland	M and M Equestrians		
241	Dixie McKibbin	McColley Equestrian Team		
184	Shelby VanDenBosch	Puthoff Equestrian Team		
274	Adelynn Rich	Puthoff Equestrian Team		
292	Jillian Jefferson	Puthoff Equestrian Team		
159	Alexis Baum	Silver Spur Equestrian Team		
251	Ava Pope	Timmermann's Show Team		
142	Kylee Rigsby	Timmermann's Show Team		

1st: 115 2nd: 446 3rd: 292 4th: 244 5th: 251 6th: 184 7th: 311 8th: 142

**AWARDS PRESENTATION**  
**Horse of the Day | JR High Point Rider Awards**  
**EquiFUSE Best Grooming Award**

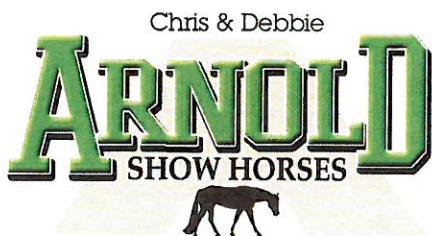

Home 419-895-1864 ■ Cell 419-564-0124  
 2415 St. Rt. 603 ■ Ashland, OH 44805

**Patty McCartin Show Horses**  
 Training-Showing-Sales-Lessons-Judging  
**Specializing in the All Around Pleasure Horse**  
 PO Box 129  
 New Haven, Ohio 44850  
**419-706-2861**

*Congrats & Good Luck to all YEDA Nationals Qualifiers!*



**So proud of our YEDA qualifiers!  
Shayna Rigsby, Kylee Rigsby, Ava Pope  
and Abigail Shew**

**We sell the best horses & train the rest!  
Quality Horses for Sale at all times!**

**TIMMERMANN'S  
RANCH &  
SADDLE SHOP**

**847-526-8066**

**Horses for Sale • Saddle Shop • Riding Lessons  
29550 W. Roberts Road • Island Lake, IL  
timmermannsranch.com**



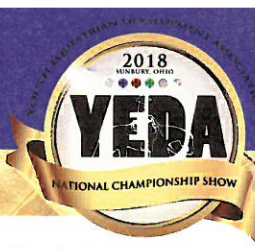

## SATURDAY HIGH POINT RIDER RESULTS

Senior High School Team		Junior High School Team	
High Point Rider	Aria Morgan Hancock Horseman	High Point Rider	Violet Snetter M & M Equestrian Team
Reserve High Point Rider	Peyton Derr Hancock Horseman	Reserve High Point Rider	Grace Casebolt Hancock Horseman
Schneiders Horse of the Day		Dusty KCDH	
Sportsmanship Awards		Aria Morga     Kaitlyn Worthman Nathan Sparren	
EquiFUSE Best Grooming Award		Pokey Southern OHIO	

2017 YEDA NATIONAL INDIVIDUAL SENIOR HIGH POINT RIDER: Peyton Derr Hancock Horseman  
 2017 YEDA NATIONAL INDIVIDUAL JUNIOR HIGH POINT RIDER: Brianna Merklin Bay Hill Farm



*"If your tail isn't becoming to you, you should be coming to me."*

K.C. Cell: 913.244.7201  
 Kathy Cell: 419.771.0037  
 E: kathywilliams811@hotmail.com

10961 U.S. Rt. 127  
 Mendon, Ohio 45862  
 www.kathytails.com

GOODLUCK TO ALL THE PARTICIPANTS  
AT THE 2018 YEDA NATIONALS

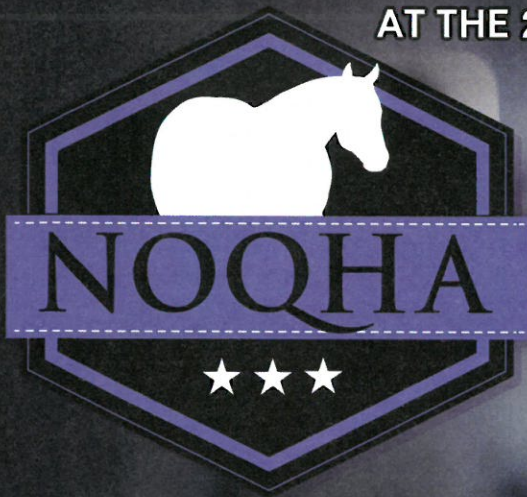
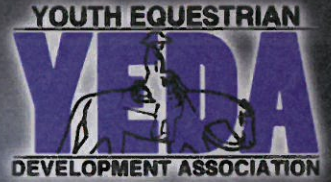

**NOQHA Spring Extravaganza**  
May 25 - 27, 2018  
Findlay Western Farm

**NOQHA Novice Show**  
May 28, 2018  
Findlay Western Farm

**NOQHA Summer Six Pack Circuit**  
June 21-24, 2018  
Findlay Western Farm

**NOQHA Fall Extravaganza**  
September 1-2, 2018  
Sunbury Eden Park



Building the Foundation  
for the Future Youth

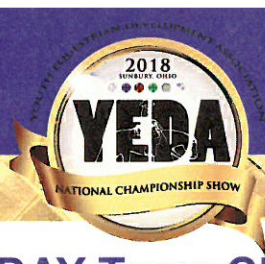

## SUNDAY Team Classes April 29, 2018

**2017 Champion High School Team: Bay Hill Farm Equestrian Team**  
**2017 Champion Middle School Team: Hancock Horseman Equestrian Team**

### Class 1 Team Group 20 Senior High Diamond Reining (9)

<i>Back#</i>	<i>Name</i>	<i>Team</i>	<i>Draw</i>	<i>Horse</i>
198	Violet Romanak	Arnold Equestrian Team		
371	Madison Pendleton	Bay Hill Farm		
271	Nathan Sparren	Equine Differences		
487	Peyton Derr	Hancock Horseman		
246	Cassidy Morgan	KCPH Equestrian Team		
355	Lexi Fosburg	M and M Equestrians		
197	Lori Girrback	McColley Equestrian Team		
341	Isabella Tesmer	Southern Ohio Equestrian Team		
178	Alexa Mier	The Grimm Riders		

1st: 487 2nd: 355 3rd: 341 4th: 197 5th: 198 6th: 271

### Class 2 Team Group 13 Senior High Emerald Rail Horsemanship (10)

<i>Back#</i>	<i>Name</i>	<i>Team</i>	<i>Draw</i>	<i>Horse</i>
326	Robin Danczak	Arnold Equestrian Team		
388	Carrie Leeper	Bay Hill Farm		
412	Jessica Sebolt	Champion Hill Equestrian Team		
170	Ethan Baughman	Hancock Horseman		
141	Alyssa Detillion	KCPH Equestrian Team		
493	Tess Yuhaschek	M and M Equestrians		
488	Dessa Weed	McColley Equestrian Team		
338	Kayla Wall	Puthoff Equestrian Team		
340	McKenzie Murphy	Southern Ohio Equestrian Team		
221	Sarah Burneson	The Grimm Riders		

1st: 170 2nd: 488 3rd: 388 4th: 338 5th: 340 6th: 221



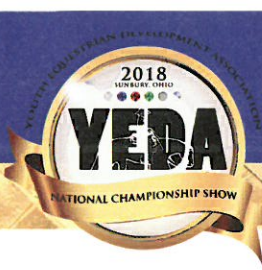

Class 3 Team Group 11 Senior High Opal Rail Horsemanship (10)

<i>Back#</i>	<i>Name</i>	<i>Team</i>	<i>Draw</i>	<i>Horse</i>
146	Jana Eicher	Bay Hill Farm		
155	Hailey Krzynowek	Champion Hill Equestrian Team		
304	Cori Reitmann	Equine Differences		
135	Victoria Ross	Hancock Horseman		
257	Kimberlyn Ousley	KCPH Equestrian Team		
263	Kalyn Dewey	McColley Equestrian Team		
382	Hailey Vaughn	Puthoff Equestrian Team		
174	Sarah Twine	Southern Ohio Equestrian Team		
298	Loren Smith	The Grimm Riders		
439	Kaitlin Vojacek	Triple Edge Equestrian Team		

1st: 263 2nd: 298 3rd: 146 4th: 155 5th: 304 6th: 257

Class 4 Team Group 5 Junior High Emerald Rail Horsemanship (10)

<i>Back#</i>	<i>Name</i>	<i>Team</i>	<i>Draw</i>	<i>Horse</i>
462	Jada Lowery	Arnold Equestrian Team		
137	Kennedy Kirkham	Bay Hill Farm		
420	Emily Cox	Champion Hill Equestrian Team		
233	Kendall Bauman	Edge Equestrian		
191	Hayden Miller	Equine Differences		
393	Elijah Baughman	Hancock Horseman		
422	Allysen Cundiff	KCPH Equestrian Team		
413	Madelyn Kvicala	McColley Equestrian Team		
127	Skylar Livengood	Silver Spur Equestrian Team		
295	Dakota Prater	Triple Edge Equestrian Team		

1st: 462 2nd: 393 3rd: 127 4th: 295 5th: 137 6th: 422

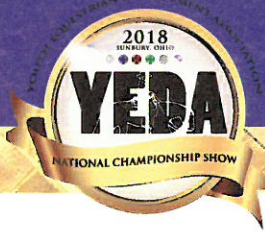

Class 5 Team Group 3 Junior High Opal Rail Horsemanship (12)

<i>Back#</i>	<i>Name</i>	<i>Team</i>	<i>Draw</i>	<i>Horse</i>
208	Hannah Whitney	Arnold Equestrian Team		
110	Ainsley Rhoades	Bay Hill Farm		
163	Madeline McBride	Champion Hill Equestrian Team		
148	Kaila Kocsis	Edge Equestrian		
118	Jocelyn Taylor	Equine Differences		
383	Lexi Edwards	Hancock Horseman		
369	Kaylyn Warthman	Hickory Ridge Equestrian Team		
317	Luke Arnold	KCPH Equestrian Team		
348	Kendra Hochstedler	McColley Equestrian Team		
282	Lillian Alexander	Puthoff Equestrian Team		
122	Eleanor Hughes	Silver Spur Equestrian Team		
300	Abbey Roehrenbeck	Triple Edge Equestrian Team		

1st: 383 2nd: 110 3rd: 300 4th: 369 5th: 348 6th: 118

Class 6 Team Group 14 Senior High Emerald Pattern Horsemanship (10)

<i>Back#</i>	<i>Name</i>	<i>Team</i>	<i>Draw</i>	<i>Horse</i>
152	Maggie Vesper	Arnold Equestrian Team		
388	Carrie Leeper	Bay Hill Farm		
378	Emma Wirtz	Champion Hill Equestrian Team		
379	Isaiah Baughman	Hancock Horseman		
141	Alyssa Detillion	KCPH Equestrian Team		
493	Tess Yuhaschek	M and M Equestrians		
488	Dessa Weed	McColley Equestrian Team		
424	Larkin Welbaum	Puthoff Equestrian Team		
428	Kyra Butts	Southern Ohio Equestrian Team		
221	Sarah Burneson	The Grimm Riders		

1st: 488 2nd: 428 3rd: 152 4th: 493 5th: 379 6th: 141

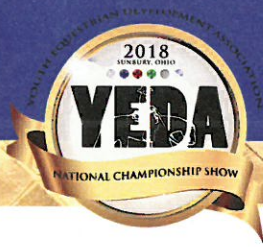

Class 7 Team Group 6 Junior High Emerald Pattern Horsemanship (10)

<b>Back#</b>	<b>Name</b>	<b>Team</b>	<b>Draw</b>	<b>Horse</b>
462	Jada Lowery	Arnold Equestrian Team		
137	Kennedy Kirkham	Bay Hill Farm		
490	Sidney Hawk	Champion Hill Equestrian Team		
233	Kendall Bauman	Edge Equestrian		
191	Hayden Miller	Equine Differences		
279	Samantha Wagner	Hancock Horseman		
205	Leah Blay	KCPH Equestrian Team		
259	Riley Long	McColley Equestrian Team		
127	Skylar Livengood	Silver Spur Equestrian Team		
295	Dakota Prater	Triple Edge Equestrian Team		

1st: 205 2nd: 137 3rd: 490 4th: 191 5th: 233 6th: 295

Class 8 Team Group 12 Senior High Opal Pattern Horsemanship (9)

<b>Back#</b>	<b>Name</b>	<b>Team</b>	<b>Draw</b>	<b>Horse</b>
146	Jana Eicher	Bay Hill Farm		
304	Cori Reitmann	Equine Differences		
135	Victoria Ross	Hancock Horseman		
257	Kimberlyn Ousley	KCPH Equestrian Team		
234	Asya Modert	McColley Equestrian Team		
382	Hailey Vaughn	Puthoff Equestrian Team		
174	Sarah Twine	Southern Ohio Equestrian Team		
298	Loren Smith	The Grimm Riders		
439	Kaitlin Vojacek	Triple Edge Equestrian Team		

1st: 146 2nd: 257 3rd: 382 4th: 298 5th: 174 6th: 135

*Congratulations*

To our JR and SR High Teams...  
 2018 National Qualifiers



*Individual Qualifiers*

*Marissa Henry*



*Lexi Fosburg*



*Violet Shetler*



*Tess Yuhatschek*



*Ayla Ruland*



*Emma Zgrebnak*



*Zoey Howell*



*Sydney Preston*



2  
0  
1  
8

COACHES:

MELISSA HENRY-SHETLER AND SHAUNA BROWN

AD BY KATHY SPECK

*Creating a winning legacy  
for more than 40 years*

## **Equestrian Team Coaches**

Rebekah Irish      520-247-9376

Sarah Schobert      540-597-2408

 Black Hawk College Equine Science Program

**Black**   
**Hawk College**

East Campus | Galva, Illinois

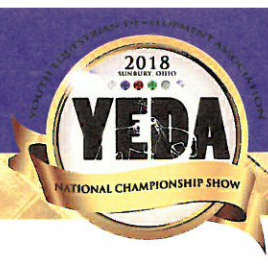

**Class 9 Team Group 4 Junior High Opal Pattern Horsemanship (12)**

<b>Back#</b>	<b>Name</b>	<b>Team</b>	<b>Draw</b>	<b>Horse</b>
208	Hannah Whitney	Arnold Equestrian Team		
110	Ainsley Rhoades	Bay Hill Farm		
128	Lexie Williams	Champion Hill Equestrian Team		
148	Kaila Kocsis	Edge Equestrian		
470	Chelsea Manning	Equine Differences		
227	Anna Divis	Hancock Horseman		
125	Abby Kerns	Hickory Ridge Equestrian Team		
317	Luke Arnold	KCPH Equestrian Team		
418	Evan McColley	McColley Equestrian Team		
486	Olivia England	Puthoff Equestrian Team		
122	Eleanor Hughes	Silver Spur Equestrian Team		
300	Abbey Roehrenbeck	Triple Edge Equestrian Team		

1st: 208 2nd: 227 3rd: 470 4th: 418 5th: 122 6th: 317

**LUNCH BREAK**

**Coaches Walk Trot Horsemanship Class**

*(Judged by Saturday's High Point & Reserve High Point SR Riders)*

*Class is a calcutta, with 50% of proceeds going to the SIF & 50% to the winning rider's buyer.*

**Class 10 Team Group 17 Senior High Sapphire Rail Horsemanship (9)**

<b>Back#</b>	<b>Name</b>	<b>Team</b>	<b>Draw</b>	<b>Horse</b>
211	Maryn Klaus	Arnold Equestrian Team		
344	Brianna Merklin	Bay Hill Farm		
481	Eli Wolfe	Equine Differences		
466	Jordan Schauer	Hancock Horseman		
134	Brooklyn Wright	KCPH Equestrian Team		
232	Zoey Howell	M and M Equestrians		
166	Adison Miller	McColley Equestrian Team		
176	Matthew Siefker	Puthoff Equestrian Team		
302	Katie Anderholm	The Grimm Riders		

1st: 134 2nd: 176 3rd: 344 4th: 166 5th: 211 6th: 232



Class 11 Team Group 15 Senior High Ruby Rail Horsemanship (9)

<b>Back#</b>	<b>Name</b>	<b>Team</b>	<b>Draw</b>	<b>Horse</b>
219	Grace Murphy	Arnold Equestrian Team		
458	Sydney Mayer	Bay Hill Farm		
334	Micaela Jackson	Equine Differences		
329	Dane Creps	Hancock Horseman		
231	Taylor Klimmer	McColley Equestrian Team		
436	Katzya Suerdick	Puthoff Equestrian Team		
245	Rose Dean	Southern Ohio Equestrian Team		
156	Abby Watt	The Grimm Riders		
320	Emma Mattox	Triple Edge Equestrian Team		

1st: 231 2nd: 329 3rd: 458 4th: 219 5th: 436 6th: 156

Class 12 Team Group 9 Junior High Sapphire Rail Horsemanship (8)

<b>Back#</b>	<b>Name</b>	<b>Team</b>	<b>Draw</b>	<b>Horse</b>
479	Katelynn Smeltzer	Arnold Equestrian Team		
260	Ava Coughlin	Bay Hill Farm		
117	Olivia Lott	Edge Equestrian		
140	Quinn Foor	Equine Differences		
154	Gracie Casebolt	Hancock Horseman		
459	Katie Ruffener	KCPH Equestrian Team		
121	Alyvia Dixon	McColley Equestrian Team		
394	Darby Welbaum	Puthoff Equestrian Team		

1st: 121 2nd: 459 3rd: 260 4th: 479 5th: 394 6th: 154



MIAMI  
UNIVERSITY

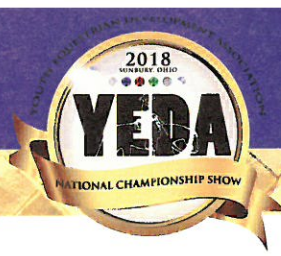

Class 13 Team Group 7 Junior High Ruby Rail Horsemanship (11)

<i>Back#</i>	<i>Name</i>	<i>Team</i>	<i>Draw</i>	<i>Horse</i>
201	Paige Mullins	Arnold Equestrian Team		
218	Evan Merklin	Bay Hill Farm		
452	Cassidy Kennedy	Champion Hill Equestrian Team		
264	Chloe Jansen	Equine Differences		
438	Skylar Super	Hancock Horseman		
321	Kaylee Bond	Hickory Ridge Equestrian Team		
165	Taylor Nelson	KCPH Equestrian Team		
343	Hailey Smith	McColley Equestrian Team		
228	Isabella O'Daniel	Puthoff Equestrian Team		
249	Adrianna Runzo	Silver Spur Equestrian Team		
476	Mekenzie Stiffler	Triple Edge Equestrian Team		

1st: 438 2nd: 249 3rd: 165 4th: 476 5th: 228 6th: 264

Class 14 Team Group 18 Senior High Sapphire Pattern Horsemanship (9)

<i>Back#</i>	<i>Name</i>	<i>Team</i>	<i>Draw</i>	<i>Horse</i>
211	Maryn Klaus	Arnold Equestrian Team		
344	Brianna Merklin	Bay Hill Farm		
481	Eli Wolfe	Equine Differences		
442	Kylee Simpson	Hancock Horseman		
134	Brooklyn Wright	KCPH Equestrian Team		
232	Zoey Howell	M and M Equestrians		
166	Adison Miller	McColley Equestrian Team		
176	Matthew Siefker	Puthoff Equestrian Team		
302	Katie Anderholm	The Grimm Riders		

1st: 344 2nd: 442 3rd: 134 4th: 232 5th: 481 6th: 176





Class 15 Team Group 16 Senior High Ruby Pattern Horsemanship (9)

<b>Back#</b>	<b>Name</b>	<b>Team</b>	<b>Draw</b>	<b>Horse</b>
331	Bailey VanDriest	Arnold Equestrian Team		
458	Sydney Mayer	Bay Hill Farm		
416	Anacecilia McKay Lodge	Equine Differences		
347	Austen Nissen	Hancock Horseman		
114	Mikaela Gleeson	McColley Equestrian Team		
316	Sierra Keller	Puthoff Equestrian Team		
245	Rose Dean	Southern Ohio Equestrian Team		
156	Abby Watt	The Grimm Riders		
320	Emma Mattox	Triple Edge Equestrian Team		

1st: 316 2nd: 458 3rd: 114 4th: 320 5th: 331 6th: 416

Class 16 Team Group 8 Junior High Ruby Pattern Horsemanship (10)

<b>Back#</b>	<b>Name</b>	<b>Team</b>	<b>Draw</b>	<b>Horse</b>
201	Paige Mullins	Arnold Equestrian Team		
218	Evan Merklin	Bay Hill Farm		
492	Benjy Norton	Equine Differences		
438	Skylar Super	Hancock Horseman		
321	Kaylee Bond	Hickory Ridge Equestrian Team		
165	Taylor Nelson	KCPH Equestrian Team		
343	Hailey Smith	McColley Equestrian Team		
242	Erin Keihl	Puthoff Equestrian Team		
249	Adrianna Runzo	Silver Spur Equestrian Team		
476	Mekenzie Stiffler	Triple Edge Equestrian Team		

1st: 165 2nd: 249 3rd: 242 4th: 201 5th: 321 6th: 476



Class 17 Team Group 19 Senior High Diamond Rail/Pattern Horsemanship (9)

<i>Back#</i>	<i>Name</i>	<i>Team</i>	<i>Draw</i>	<i>Horse</i>
198	Violet Romanak	Arnold Equestrian Team		
339	Emily Coe	Bay Hill Farm		
248	Ciara Lawson	Equine Differences		
487	Peyton Derr	Hancock Horseman		
246	Cassidy Morgan	KCPH Equestrian Team		
390	Marissa Henry	M and M Equestrians		
197	Lori Girrbach	McColley Equestrian Team		
341	Isabella Tesmer	Southern Ohio Equestrian Team		
178	Alexa Mier	The Grimm Riders		

1st: 487 2nd: 197 3rd: 198 4th: 390 5th: 178 6th: 246

Class 18 Team Group 10 Junior High Sapphire Pattern Horsemanship (8)

<i>Back#</i>	<i>Name</i>	<i>Team</i>	<i>Draw</i>	<i>Horse</i>
479	Katelynn Smeltzer	Arnold Equestrian Team		
260	Ava Coughlin	Bay Hill Farm		
117	Olivia Lott	Edge Equestrian		
400	Lauren Ferguson	Equine Differences		
496	Grace Heintschel	Hancock Horseman		
459	Katie Ruffener	KCPH Equestrian Team		
121	Alyvia Dixon	McColley Equestrian Team		
394	Darby Welbaum	Puthoff Equestrian Team		

1st: 260 2nd: 121 3rd: 394 4th: 400 5th: 117 6th: 479



**Class 19 Team Group 22 Senior High Diamond Elite Horsemanship (12)**

Back#	Name	Team	Draw	Horse
198	Violet Romanak	Arnold Equestrian Team		
339	Emily Coe	Bay Hill Farm		
271	Nathan Sparren	Equine Differences		
248	Ciara Lawson	Equine Differences		
352	Evan Thomas	Equine Differences		
151	Aria Morgan	Hancock Horseman		
487	Peyton Derr	Hancock Horseman		
246	Cassidy Morgan	KCPH Equestrian Team		
390	Marissa Henry	M and M Equestrians		
197	Lori Girrback	McColley Equestrian Team		
341	Isabella Tesmer	Southern Ohio Equestrian Team		
178	Alexa Mier	The Grimm Riders		

1st: 487 2nd: \_\_\_\_\_ 3rd: \_\_\_\_\_ 4th: \_\_\_\_\_ 5th: \_\_\_\_\_ 6th: \_\_\_\_\_

**Awards Presentation 🌟 Team Parade**

*Horse of the Day 🌟 Team Awards 🌟 EquiFUSE Best Grooming Award  
Drawing for a Seasons of Free Entries Raffle*

*Rh*  
*Rhinestone Lipglass*

- Advertising
- Annual Reports
- Appreciation/Incentive Programs
- Branding
- Brochures & Flyers
- Campaign Management
- Catalogs
- Commercial Print
- Consulting
- Corporate Brand Control
- Coupons
- Direct Mail
- eCommerce Solutions
- Electronic Communications
- Graphic Design
- Mailing Solutions
- Newsletters
- Packaging
- Program Management
- Promotional Campaigns
- Signage & Displays
- Social Media Integration
- Special Campaigns
- Web Design
- ...and Much More



**MARKETING SOLUTIONS**

Proudly serving the following **MARKETS**

- Automotive
- Education
- Entertainment
- Financial
- Government
- Hospitality
- Industrial
- Insurance
- Manufacturing
- Nonprofit
- Real Estate
- Retail
- Special Events
- Technology
- Wholesale
- ...and Many More

If you can *dream* it, we can **DELIVER** it

The success of a business depends on the positioning and execution of its marketing strategy. With our expertise and wide variety of innovative and creative solutions, we can help you promote your brand message more effectively and economically. From print and promotional products to electronic communications, we'll help create the integrated mix that will take your ideas and initiatives to the next level.



Find us at 212 E. Columbus Ave. Suite 2  
Bellefontaine, Ohio 43311  
Ph: 937.593.1911 • Fax: 937.592.4165  
tsnapp@americanbus.com  
www.americanbus.com  
americanpromo.com

*American*  
Solutions for Business  
formerly RATH Information Systems

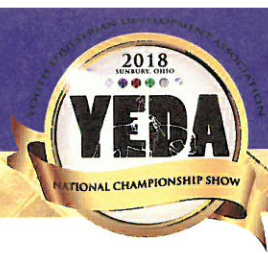

## SUNDAY HIGH POINT TEAM RESULTS

Senior High School Team		Junior High School Team	
High Point Team	Mc Colley	High Point Team	Hancock Horseman
Reserve High Point Team	Bay Hill Farm	Reserve High Point Team	KCPH Equestrian Team
Schneiders Horse of the Day		Pokey (Southern OHIO)	
Sportsmanship Awards		Dessa weed Lily Trivett Brianna Merkh	
EquiFUSE Best Grooming Award AM		Zolf (Triple Edge ET)	

2017 YEDA NATIONAL HIGH SCHOOL TEAM CHAMPION: Bay Hill Farm  
 2017 YEDA NATIONAL JUNIOR HIGH SCHOOL TEAM CHAMPION: Hancock Horseman

## Sauder Pleasure Horses

Steve and Ty Sauder  
training/sales

1500 Bowen Rd.  
Mansfield, Ohio 44903

419-589-7031 home  
419-512-2798 cell

**Good luck to all YEDA exhibitors!**

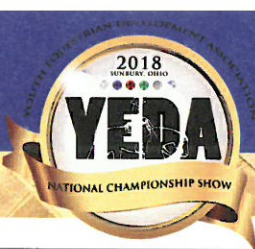

### Senior High Scoreboard

Team	Diamond Reining	Diamond Rail/Pattern Horsemanship	Sapphire Pattern Horsemanship	Sapphire Rail Horsemanship	Ruby Pattern Horsemanship	Ruby Rail Horsemanship	Emerald Pattern Horsemanship	Emerald Rail Horsemanship	Opal Pattern Horsemanship	Opal Rail Horsemanship	Total	Final Placings
Arnold	2	4	0	2	2	3	4	0	-	-	17	6 <sup>TH</sup>
Bay Hill	0	0	6	4	5	4	0	4	6	4	33	2 <sup>ND</sup>
Champion Hill	-	-	-	-	-	-	0	0	-	3	3	12 <sup>TH</sup>
Equine	1	0	2	0	1	0	-	-	0	2	6	10 <sup>TH</sup>
Grimm	0	2	0	0	0	1	0	1	3	5	12	9 <sup>TH</sup>
Hancock	6	6	5	0	0	5	2	6	1	0	31	3 <sup>RD</sup>
KCPH	0	1	4	6	-	-	1	0	5	1	18	5 <sup>TH</sup>
M & M Equestrians	5	3	3	1	-	-	3	0	-	-	15	7 <sup>TH</sup>
McColley	3	5	0	3	4	6	6	5	0	6	38	1 <sup>ST</sup>
Puthoff	-	-	1	5	6	2	0	3	4	0	21	4 <sup>TH</sup>
Southern Ohio	4	0	-	-	0	0	5	2	2	0	13	8 <sup>TH</sup>
Triple Edge	-	-	-	-	3	0	-	-	0	0	3	11 <sup>TH</sup>

### Junior High Scoreboard

Team	Sapphire Pattern Horsemanship	Sapphire Rail Horsemanship	Ruby Pattern Horsemanship	Ruby Rail Horsemanship	Emerald Pattern Horsemanship	Emerald Rail Horsemanship	Opal Pattern Horsemanship	Opal Rail Horsemanship	Total	Final Placings
Arnold	1	3	3	0	0	6	6	0	19	4 <sup>TH</sup>
Bay Hill	6	4	0	0	5	2	0	5	22	3 <sup>RD</sup>
Champion Hill	-	-	-	0	4	0	0	0	4	11 <sup>TH</sup>
Edge	2	0	-	0	2	0	0	0	4	12 <sup>TH</sup>
Equine	3	0	0	1	3	0	4	1	12	8 <sup>TH</sup>
Hancock	0	1	0	6	0	5	5	6	23	1 <sup>ST</sup>
Hickory Ridge	-	-	2	0	-	-	0	3	5	10 <sup>TH</sup>
KCPH	0	5	6	4	6	1	1	0	23	2 <sup>ND</sup>
McColley	5	6	0	0	0	0	3	2	16	5 <sup>TH</sup>
Puthoff	4	2	4	2	-	-	0	0	12	7 <sup>TH</sup>
Silver Spur	-	-	5	5	0	4	2	0	16	6 <sup>TH</sup>
Triple Edge	-	-	1	3	1	3	0	4	12	9 <sup>TH</sup>

# Equine Differences Equestrian Team

## *Congratulates*

### Our National Qualifiers

Sr. Diamond Reining & Horsemanship  
Sr. Diamond Team Reining  
Nathan Sparren

Sr. Diamond Team Pattern  
Ciara Lawson

Sr. Sapphire Horsemanship & Pattern  
Sr. Sapphire Team  
Eli Wolfe

Sr. Ruby Horsemanship  
Sr. Ruby Team Horsemanship  
Micaela Jackson

Sr. Ruby Team Pattern  
AnaCecilia McKay Lodge

Sr. Opal Horsemanship & Pattern  
Sr. Opal Team  
Cori Reitmann

Alumni  
Savannah Mileti

Diamond Elite  
Nathan Sparren  
Evan Thomas  
Ciara Lawson

Jr. Sapphire Horsemanship and Pattern  
Jr. Sapphire Team Horsemanship  
Quinn Foor

Jr. Sapphire Horsemanship  
Jr. Sapphire Team Pattern  
Lauren Ferguson

Jr. Ruby Horsemanship and Pattern  
Jr. Ruby Team Pattern  
Benjy Norton

Jr. Ruby Horsemanship and Pattern  
Jr. Ruby Team Horsemanship  
Chloe Jansen

Jr. Ruby Horsemanship and Pattern  
Madison Gordon

Jr. Emerald Horsemanship and Pattern  
Jr. Emerald Team  
Hayden Miller

Jr. Emerald Pattern  
Skylar Twite

Jr. Opal Horsemanship  
Jr. Opal Team Horsemanship  
Jocelyn Taylor

Jr. Opal Team Pattern  
Chelsea Manning



*Best of Luck to our  
graduating Seniors!*

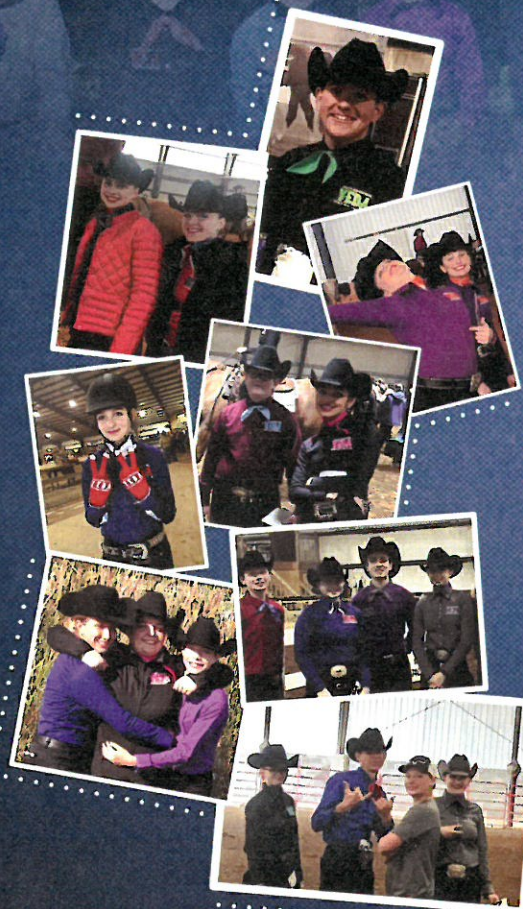

Equine Differences



Equestrian Team

Good luck to all of our qualifiers!  
Coaches Ric and Liz

# College-Supported VARSITY IHSA TEAM

Professionally focused  
academic programs  
with strong internships  
and great job placement:  
Arts and Sciences  
Business  
Criminal Justice

**SCHOLARSHIPS  
AND INTERNSHIPS  
AVAILABLE**

For more information,  
contact Coach Julie Vogel  
419.389.2090  
vogeljl@tiffin.edu

tiffin.edu

155 Miami Street  
Tiffin, OH 44883

f /TiffinU    t @TiffinU

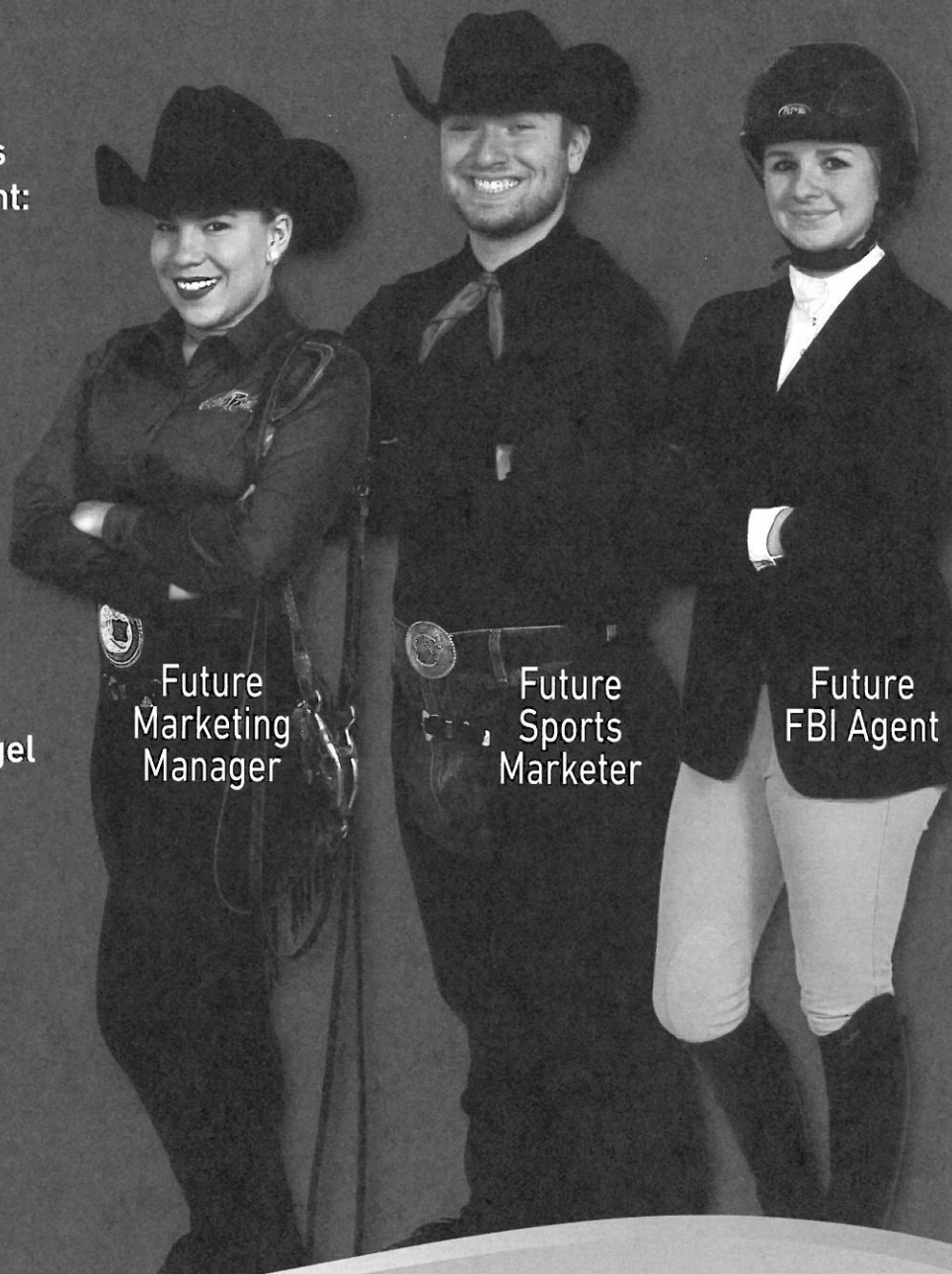

Future  
Marketing  
Manager

Future  
Sports  
Marketer

Future  
FBI Agent

# TIFFIN UNIVERSITY

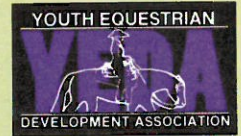

# The Friends & Families of Arnold Equestrian Team



**Wish all Individuals & Both Jr & Sr Teams  
“Good Luck”**

**At the YEDA National Championship Show**

**April 28/29, 2018**

**Honoring Our Seniors...**



**Violet Romanak**



**Carson Mullins**

**Good Luck In All You Future Plans...**

**Coach Debbie Arnold**





**PARADISE**  
*leather company*

Scott & Malinda Shipman  
2580 Ball Road, Centerburg, Ohio 43011  
740.358.5593  
paradiseleather@yahoo.com

## *Custom Leatherwork and Repair*

- **CUSTOM CHAPS**
- **CHAP ALTERATIONS**
- **SADDLE REPAIR**

# *Good Luck Competitors!*

# PATTERNS

**Sapphire/Alumni Pattern 11**

Be ready at A.

1. Jog from A to B
2. Jog a circle around B
3. At B lope on the right lead to C
4. Lope a circle around C
5. At C, perform a simple lead change and continue to D
6. At D, stop and back one horse length.

Walk .....  
Jog - - -  
Extended Jog - - -  
Lope \_\_\_\_\_  
Back ←←←  
Marker A

YOUTH EQUESTRIAN DEVELOPMENT ASSOCIATION

**Sapphire/Alumni Pattern 10**

Be ready at A

1. Right lead lope to and around C
2. Halfway to D, break to the jog
3. Jog around D
4. Halfway to B, extend the jog
5. Continue extended jog around B to D
6. at D stop and back approximately one horse length.

Walk .....  
Jog - - -  
Extended Jog - - -  
Lope \_\_\_\_\_  
Back ←←←  
Marker A

YOUTH EQUESTRIAN DEVELOPMENT ASSOCIATION

**Emerald Pattern 8**

1. Walk to A
2. At A, jog to B
3. At B, jog a circle to the left
4. At close of circle, lope left lead to and around C to D.
5. At D, stop and back 4 steps.

Walk .....  
Jog - - -  
Extended Jog - - -  
Lope \_\_\_\_\_  
Back ←←←  
Marker A

YOUTH EQUESTRIAN DEVELOPMENT ASSOCIATION

**Emerald Pattern 10**

1. Walk to A
2. At A, jog to B
3. At B, lope on the right lead to C
4. At C, lope a circle to the right to D
5. At D, break to a jog.
6. At E, stop and back one horse length.

Walk .....  
Jog - - -  
Extended Jog - - -  
Lope \_\_\_\_\_  
Back ←←←  
Marker A

YOUTH EQUESTRIAN DEVELOPMENT ASSOCIATION

## PATTERNS

**Opal/Pearl Pattern 7**

1. Walk to A
2. At A, jog to B
3. At B, jog a circle to the left
4. At close of circle, continue jogging to C
5. At C, stop and back
6. Jog to D
7. At D, stop.

Walk .....  
Jog - - -  
Extended Jog — —  
Back ← — — —  
Marker ⓐ

YOUTH EQUESTRIAN  
**YEDA**  
DEVELOPMENT ASSOCIATION

**Opal/Pearl Pattern 12**

1. Jog A to B
2. At B, jog a circle to the left
3. Continue jogging around C to D
4. At D, jog a circle to the left.
5. After completion of circle, break to a walk at D to E
6. At E, stop.

Walk .....  
Jog - - -  
Extended Jog — —  
Back ← — — —  
Marker ⓐ

YOUTH EQUESTRIAN  
**YEDA**  
DEVELOPMENT ASSOCIATION

**Ruby Pattern 9**

1. Be ready at A
1. Walk from A to B
2. At B, jog to C
3. Stop and perform a 180 degree turn to the left
4. Jog a circle around C
5. Stop at C and perform a 180 degree turn to the right
6. Lope on the right lead to D
7. Stop at D and back approximately one horse length.

Walk .....  
Jog - - -  
Extended Jog — —  
Lope — — — —  
Back ← — — —  
Marker ⓐ

YOUTH EQUESTRIAN  
**YEDA**  
DEVELOPMENT ASSOCIATION

**Ruby Pattern 12**

1. Walk to cone A
2. Lope on left lead from A to B
3. At B break to jog
4. Jog around C to D
5. At D, extend the jog to E
6. At E, stop, perform a 180 degree turn to the left
7. Lope right lead from E back to B
8. At B break to a jog to A
9. At A, stop and back 5 steps.

Walk .....  
Jog - - -  
Extended Jog — —  
Lope — — — —  
Back ← — — —  
Marker ⓐ

YOUTH EQUESTRIAN  
**YEDA**  
DEVELOPMENT ASSOCIATION

## PATTERNS



### Diamond Pattern 10



- Jog A to C
- Stop at C and perform a 180 degree turn to the right
- Lope a circle around C on the right lead
- Stop at C and perform a 90 degree turn to the left
- Extended Jog to D
- Stop at D and back approximately one horse length

Walk -----  
 Jog - - - - -  
 Extended Jog - - - - -  
 Lope - - - - -  
 Back <->>>>>  
 Marker (C)



### Diamond Pattern 11



- Walk to A
- At A jog to B
- Stop at B and perform a 360 degree turn to the right
- Lope a circle to the left
- At B perform a simple lead change and continue to C
- At C, stop and back 5 steps

Walk -----  
 Jog - - - - -  
 Extended Jog - - - - -  
 Lope - - - - -  
 Back <->>>>>  
 Lead Change //  
 Marker (C)



### Diamond Pattern 12



- Walk to A
- At A jog to B
- Stop at B and perform a 360 degree turn to the right
- Lope a circle to the left
- At B perform a flying lead change and continue to C
- At C, stop and back 5 steps

Walk -----  
 Jog - - - - -  
 Extended Jog - - - - -  
 Lope - - - - -  
 Back <->>>>>  
 Lead Change //  
 Marker (C)

VIEW & PURCHASE  
YOUR PHOTOS FROM  
NATIONALS!

[SARAHGENTRYPHOTOGRAPHY.ZENFOLIO.COM](http://SARAHGENTRYPHOTOGRAPHY.ZENFOLIO.COM)



*Sarah Gentry Photography*

[HORSEIMAGE@FRONTIER.COM](mailto:HORSEIMAGE@FRONTIER.COM)  
419-651-7573 | WEST SALEM, OHIO

# ◆ CONGRATULATIONS

---

*Thank you YEDA for developing  
tomorrow's Equine Professionals!*

---



MARCIA HIGNETT

10860 DURKEE ROAD

GRAFTON, OHIO 44044

[mjhquarterhorses@frontier.com](mailto:mjhquarterhorses@frontier.com)

CELL: 440-452-6379

FARM: 440-748-2235

TRAINING ~ SALES ~ LESSONS

---

*Special thanks to our Equine Staff:*

*Jess Kiddin MTK "Jess"*

*Made by Chic "Grinder"*

*"Bob"*

---

## NRHA PATTERN 3

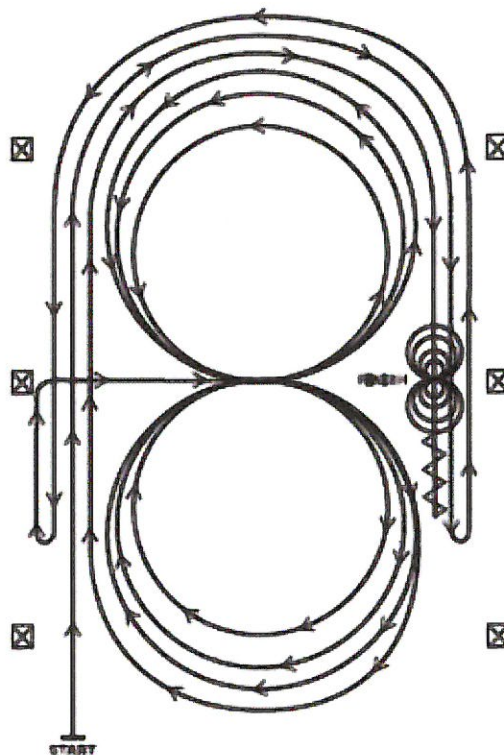

1. Beginning, lope straight up the left side of the arena, circle the top end of the arena, and staying at least twenty feet (six meters) from the walls or fence, run straight down the opposite or right side of the arena past the center marker and do a left rollback—no hesitation.
2. Continue straight up the right side of the arena circle back around the top of the arena, and staying at least twenty feet (six meters) from the walls or fence, run straight down the left side of the arena past the center marker and do a right rollback—no hesitation.
3. Continue up the left side of the arena to the center marker. At the center marker, the horse should be on the right lead. Guide the horse to the center of the arena on the right lead and complete three circles to the right: the first two circles large and fast; the third circle small and slow. Change leads at the center of the arena.
4. Complete three circles to the left: the first two circles large and fast; the third circle small and slow. Change leads in the center of the arena.
5. Begin a large circle to the right but do not close this circle. Continue up the left side of the arena, circle the top of the arena, and staying at least twenty feet (six meters) from the walls or fence, run straight down the opposite or right side of the arena past the center marker and do a sliding stop. Back up at least ten feet (three meters). Hesitate.
6. Complete four spins to the right. Hesitate.
7. Complete four spins to the left. Hesitate to demonstrate completion of the pattern.



## NRHA PATTERN 9

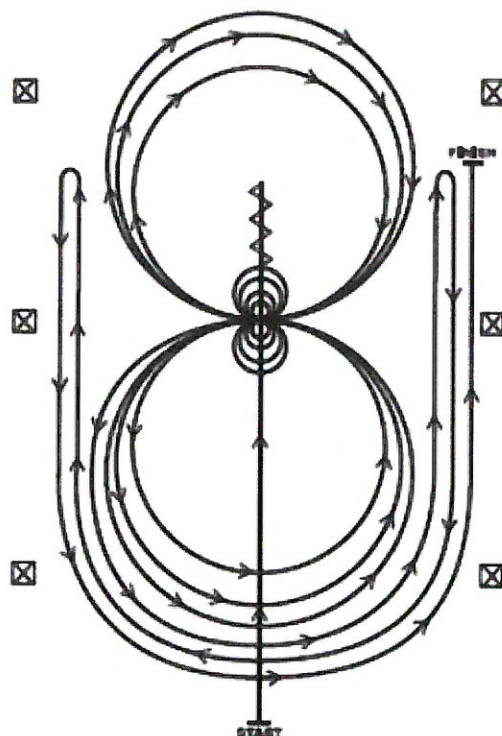

1. Run past the center marker and do a sliding stop. Backup to the center of the arena or at least ten feet (three meters). Hesitate.

2. Complete four spins to the right. Hesitate.

3. Complete four and one-quarter spins to the left so that horse is facing the left wall or fence. Hesitate.

4. Beginning on the left lead, complete three circles to the left: the first circle small and slow; the next two circles large and fast. Change leads at the center of the arena.

5. Complete three circles to the right: the first circle small and slow; the next two circles large and fast. Change leads at the center of the arena.

6. Begin a large circle to the left but do not close this circle. Run up the right side of the arena past the center marker and do a right rollback at least twenty feet (six meters) from the wall or fence—no hesitation.

7. Continue back around the previous circle but do not close this circle. Run up the left side of the arena past the center marker and do a left rollback at least twenty feet (six meters) from the wall or fence—no hesitation.

8. Continue back around previous circle but do not close this circle. Run up right side of the arena past the center marker and do a sliding stop at least twenty feet (six meters) from the wall or fence. Hesitate to demonstrate completion of the pattern.

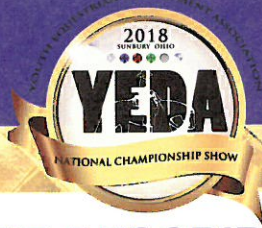

## HORSE DESCRIPTIONS

- Jess:** (MH) Does all maneuvers very well. Rides with light bit contact. Can get quick in the run down to stops. Rider can wear spurs.
- Grinder:** (MH) Does all maneuvers well, needs to be pushed into bridle and supported to stops. Otherwise, he will front end his stops. Light contact on bit and guided with riders legs.
- Bob:** (MH) Reiner, Good Draw, Nice Rollback and Spins. NO SPURS. Rider should use upper leg to cue for lead changes. Very responsive to rider cues.
- Forrest:** (Arnold) Light rein contact. Rowel or ball spur depending on division. Use hand and leg to support into lope transition and to collect on rail. Has spur stop for patterns.
- Freddie:** (Arnold) Good Draw. Light contact. Walk trot classes only
- Rocky:** (Arnold) Light rein contact. No Spurs. May anticipate on patterns. Just don't rush him in transitions. No Spurs. Let horse holder put numbers in number holders HATES to have his flank area touched. Great to ride. Great Draw. Great walk/trot horse.
- Sissy:** (Arnold) Light rein contact. Support with hand and use leg to collect. Needs to be set up for right lead. Hand to rail and push hip in. Ball spurs optional.
- Emmett:** (BayHill) sorrel gelding, can be lazy, keep bridled, spurs or crop.
- Danny:** (BayHill) sorrel gelding, light contact. If you hold too tight he won't go forward. Set up for leads, no spurs.
- Bella:** (Bayhill) Good Spins. Good lead changes. Will get restless in the middle so don't stand very long. she will get hot if you try to run her too hard. Spurs ok
- Ginger:** (BayHill) sorrel mare, great draw, light contact. Set up for leads, spurs or crop
- Sly:** (BayHill) Bay Gelding, set up for leads. Smooth lope and trot. Can go without spurs. Great Pattern Horse, Reiner
- Hope:** (Champion Hill) Consistent, Keep on the Rail always the same horse. Good with voice. Will start dropping her shoulder as day goes on. NO SPURS
- Stan:** (EQD) Sorrel POA Gelding. Ht/Wt Horse - Can get quick, hold with quiet rein. Set up for leads. May need spurs later day.
- Sarah:** (EQD) Sorrel Paint Mare. Spurs optional. Ride with light contact. Will drift to inside if allowed.
- Junior:** (EQD) Bay QH Gelding. Ranch type horse, has some reining training. Responds quickly off of cues. Will go slow if asked but need to keep in the bridle. Set up for right lead. Spurs ok
- Cooper:** (EQD) Brown Paint Gelding, Steer with legs. Adjust speed with reins. Lope can get big. No Spurs.
- Izzy:** (Hancock) No spurs, Ranch type mover with lots of drive don't pick a fight with her face. Wrap your legs around her to support her forward will work best with being asked to respond instead of told to react avoid sharp demands with legs



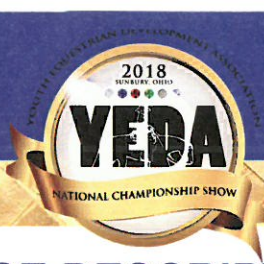

## HORSE DESCRIPTIONS

**Milo:** (Hancock) For Reining: keep him bridled up and focused. Ride through your lead changes, easy spins, will run off into stops if you let him make him wait to build speed sit down with weight forward in feet to stop. For Horsemanship: Lazy, will jog for W/T but level appropriate spurs for lope classes keep him forward in his lope to get true gait

**Gator:** (Hancock) Quiet-lazy will be good for W/T but use level appropriate spurs for lope classes very honest good draw don't trap his face

**Bree:** (Hancock) No spurs, slow smooth ride, light rein contact, set up for right lead

**Fiat:** (Hancock) No spurs, Ranch type, lopes with a lot of drive but not a lot of speed she will break if you quit riding. Set up for leads

**Chester:** (Hancock) Chestnut Quarter Horse Gelding. Good draw. Stay relaxed on him. Can ride with light contact. Easy draw and great pattern horse. Squeeze to slow down and kiss to lope off. Talk to him when you stop and break down to trot or walk. Ball spurs preferred but can use rowel.

**Remi:** (Hancock) Sorrel Quarter Horse Mare. Good draw. Ride with light contact. Has a leg release stop. Set up for leads. Great pattern horse. To slow down release your legs off of her, but not so much she will stop. Do not squeeze to slow her down, it will make her go faster. Ball spurs only.

**Pride:** (Hickory Ridge) Black Paint Gelding, No Spurs. Prefers to be ridden with some contact. Responds best to leg contact.

**Grace:** (KCPH) This mare will ride well if you use your legs. Spur Stop, Division appropriate spurs allowed. Rides best with little to no contact.

**Dusty:** (KCPH) - He is a leg horse. Rides best with little to no contact in the bridle. Spur Stop. Division appropriate spurs allowed. Will lope sideways if you push too hard with one leg.

**Raider:** (KCPH) Walk/Jog Only. Power steering, has a spur stop, so squeeze to stop. He also responds well to verbal cues. Great Draw.

**Bud:** (McColley) Spur stop, light contact; has lead change so watch legs during lope; No Spurs except for the diamond elite class, but not needed for Walk Trot. Good Draw. Nice Pattern Horse!

**Jake:** (McColley) Medium Contact; Spurs recommended, keep a soft leg, leg release stop, responds to voice commands, do not use in patterns with spins. Don't trap him in reverse. Good Draw. Keep his attention, he can get distracted.

**Tuffy:** (McColley) Spurs recommended, setup for right lead, leg release to stop, light contact, will jog and lope slow but you have to make him and it requires a lot of leg, responds to voice command. Requires leg contact at the lope. Can have contact if leg is there to back it up. Good Draw. Set up for Right Lead.

**Suzie:** (McColley) Light to medium contact (do not overbridle!). Ball spurs or no spurs depending on division, spur trained, responds well to and recommend using voice commands, very quiet slow loper, can be crabby if passed too closely, DO NOT ADJUST GIRTH, appropriate for all divisions, will excel more in rail vs pattern classes

# The Southern Ohio Equestrian Team



Showing at the YEDA National Championship Show

*In Loving Memory of*



*Margaret Sue Mulford*



Kyra Butts  
Senior High Emerald



Rosie Dean  
Senior High Ruby



Sarah Twine  
Senior High Opal



*Blue  
for Sue*

*"Take pride in how far  
you have come and have faith in  
how far you can go"*

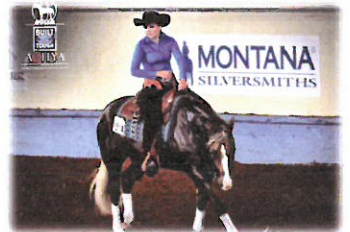

Isabella Tesmer  
Senior High Diamond



McKenzie Murphy  
Senior High Emerald



Madison Brown  
Alumni



## HORSE DESCRIPTIONS

**Corcha:** (M&M) Reining type, can go slow on the rail. Spurs Ok Very lazy.

**Jay:** (M&M) more pleasure type but without the spur stop. Need to encourage a slow walk.  
Very easy looper and jogger

**Travis:** (Puthoff) Very Good Draw, No Spurs (may change to Ball Spurs later in the day, check with the steward.) Light legs, set up for leads. He knows lead changes. Once loping don't use much leg. Don't be tight with legs.

**Dawg:** (Puthoff) Reiner & Horsemanship, No Spurs in AM, Ball Spurs or Dull Spurs in PM (Division Appropriate). LOTS of calf for lead changes. Set up for Leads, especially the right lead.

**Zip:** (Puthoff) Quiet, Easy Draw. Ball Spurs or Rowel Spurs (Division Appropriate). Lazy.  
Rough at Canter.

**Rosie:** (Royal Creek) (Saturday Only) Sorrel mare QH- retired show horse. great draw, kiss and push opposite leg to lope, cluck to trot. Works off of leg pressure to pivot. Can use any spurs or no spurs

**Coco:** (Southern Ohio) Bay Gelding, use quiet hands, light contact, use lots of leg, cluck for jog and kiss for lope, will respond to spur stop or neck rein, spurs according to division.

**Ruby:** (Southern Ohio) Appaloosa Mare, (red roan look) light contact, heavy leg, cluck for jog and kiss for lope, set up for leads. Spur according to division.

**Pokey:** (Southern Ohio) Sorrel Quarter Horse, lots of leg, light hands, click to jog, kiss to lope, move reins to neck for transitions. Spurs appropriate to class.

**Stu:** (Southern Ohio) Sorrel Gelding, good draw, quiet, takes leads, cluck for jog, kiss for lope, along with leg. Very light rein contact. Spurs according to division rules.

**Rawhide:** (Timmerman's) (Wt Horse due to age #175) Older Horse, VERY QUIET! 16 hands tall. Great for walk/trot! No Spurs, No Crop!

**Big Shot:** (Timmerman's) 15' 3 hand gelding, steady eddie horse. Great Draw. Set up for right lead, turn head until he has picked up the lead. No Spurs, No Crop!

**River:** (Triple Edge) Arab Very willing to work. Can wear spurs but ok with none. Need to stay light in his mouth. Will collect with leg pressure. Is spur trained. For pattern work he will get nervous at the first cone but if you don't make him wait he is great for patterns. Just need to stay quite with him at the start for pattern work. Weight Horse #175

**Rolf:** (Triple Edge) Fjord Gelding, He is spur trained. Very easy will do what you ask him. Can keep him bridled but also ok on a looser rein. Height 5'7"

**Manny:** (Arthur) Light contact on his face, protect his leads especially in patterns. Very light leg in patterns. Pull to slow down. Spur stop. Spurs in appropriate divisions rowels are fine.  
VERY GOOD DRAW

**Shorty:** (Arthur) Height Weight Height/Weight #175 and 5'7" No spurs ride, ranch horse type ride with Light contact not a drape rain ride off the rail can get looky. Let her walk out at the walk, rider choose her speed for jog and lope, very sensitive, light leg and hands.

# GOOD LUCK AT NATIONALS

## McColley EQUESTRIAN TEAM

Located in Hillsdale, MI  
Team Coordinator  
Amy Knowles

Congratulations  
on a very  
successful season  
and  
Good Luck at Nationals  
-Your Coaches  
Travis and Nikki  
McColley



Sr. High Diamond



Lori Girrbaach  
Sr. High Emerald

Sr. High Sapphire



Adison Miller  
Sr. High Emerald

Sr. High Ruby



Mikaela Gleeson  
Sr. High Emerald

Sr. High Ruby



Rachel Bowers  
Sr. High Opal

Sr. High Ruby



Taylor Kimmmer  
Sr. High Opal

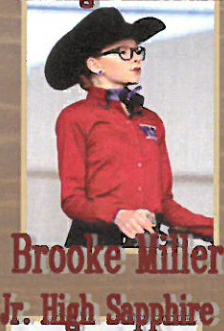

Brooke Miller  
Jr. High Sapphire

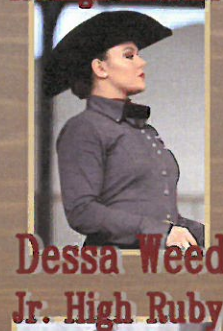

Dessa Weed  
Jr. High Ruby

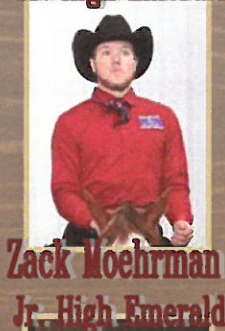

Zack Moehrman  
Jr. High Emerald

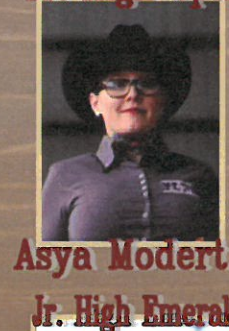

Asya Modert  
Jr. High Emerald



Kalyn Dewey  
Jr. High Opal

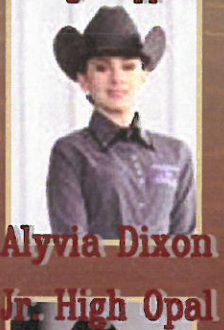

Alyvia Dixon  
Jr. High Opal

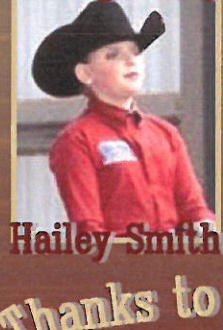

Hailey Smith



Madelyn Kvicala

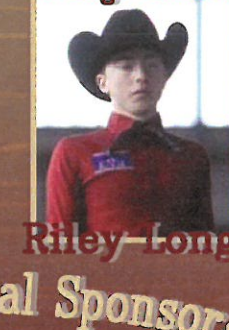

Riley Long

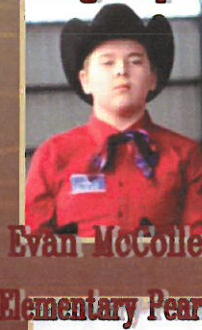

Evan McColley



Kendra Hochstedler

### Thanks to all of our National Sponsors



Litchfield Grain Co.  
Varney Beef  
Red Barn Stables  
Haylett Auto and RV  
Southern MI dock  
AY Farrier Services  
Locust Hill Stables

Yesh Metals  
Rylan Bennington  
Susan and Abby Wirick  
Twisted Brands  
TSC Jonesville, MI  
Karla Krizan Hair Designs  
Miller Trucking



Delton Family Dental Care

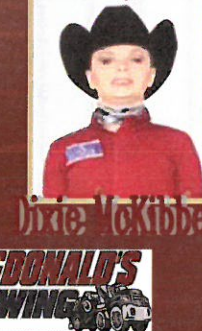
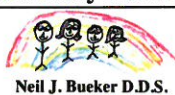

Jixie McKibben



**GIVE YOUR PASSION A FUTURE**  
**SEE IT THRU**

**B.S. in Equine Studies**

AREAS OF CONCENTRATION:

Management | Rehabilitation | Science

**MBA in Equine Studies**

100% Online | Complete in 12–18 Months

36 Credit Hours | Experienced Equine Faculty



**MIDWAY UNIVERSITY**

KENTUCKY'S EQUINE UNIVERSITY

*Equal Opportunity Institution*

GET RECRUITED AT  
**GOMIDWAYEAGLES.COM**

**MIDWAY.EDU/EQUINE • 859.846.5788**



University of Findlay®

# Western Equestrian Studies

**We are a top equestrian  
university!**

For more than 40 years, The University of Findlay has set the standard for exceptional equestrian studies.

FINDLAY, OHIO  
WWW.FINDLAY.EDU

# THE ONE PLACE FOR EVERY YOU.

[albion.edu/equestrian](http://albion.edu/equestrian)

 **ALBION**  
COLLEGE  
EQUESTRIAN

IHSA ZONE 6 REGION 4  
AQHA  
HIGH POINT RIDER  
2017 - 2018

**#OneTeam**



**Albion College**

# *Congratulations Seniors!*

**ISABELLA BARNES**

**KAITLIN VOJACEK**

**CARSON MULLINS**

**KRISTIN FOREST**

**MARISSA GIRT**

**STEPHANIE KSHYWONIS**

**LARKIN WELBAUM**

**ALYSSA RHOADES**

**BAILEY DEAL**

**ANACECILIA MCKAY LODGE**

**KAYLEE FAIR**

**SIERRA KELLER**

**EMMA MATTOX**

**MADILYN YOUNGPETER**

**BROOKLYN WRIGHT**

**METTHEW SIEFKER**

**VIOLET ROMANAK**

**EMILY COE**

**MADISON PENDLETON**

**RACHEL WILES**

**MADISON LANCE**

**CLAIRE FINDLEY**

**EVAN THOMAS**

**NATHAN SPARREN**

**SARA ROSENBERGER**

**CASSIDY MORGAN**

**LEXI FOSBURG**

**MARISSA HENRY**

*We wish you  
the best of luck*

*in all of your*

*future endeavors!*

*Love,  
Your friends at*

YOUTH EQUESTRIAN

**VERA**

DEVELOPMENT ASSOCIATION